

**Independent
guide to the
BBC MICRO!**

THE MICRO USER

Volume 2
Number 9
November 1984
£1.25



**WIN 3 Datagems
in our free contest**

Duel!

The most
infuriating
game we've
ever printed

Blockbuster!

Are you fast
enough to dodge
the gremlins
of the maze?

Discover the
wonders that lie
beyond Prestel

DFS utility
to maximise
your memory

Blow your own violin
with our sound synthesiser



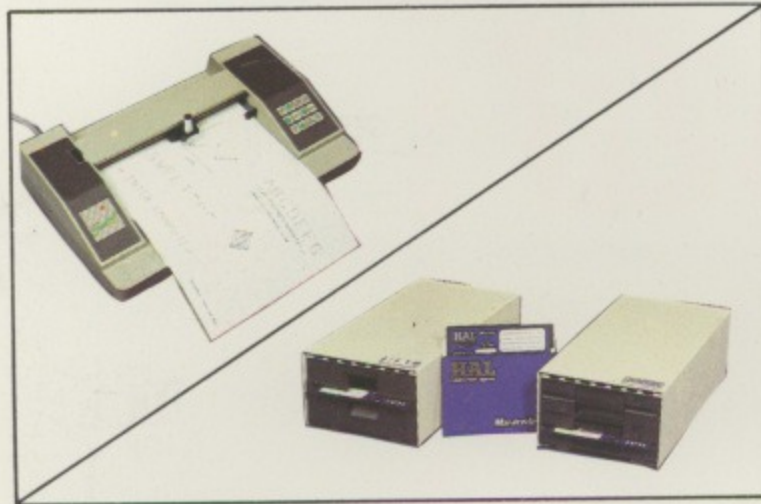

**How to conjure up
giant Mode 7 letters**

A Free Training Course with Every Plotter or Disc Drive



Our Sweet-P, high resolution graphics plotters come with free computer based demonstration and instruction programmes which not only show you what the plotter can do, but teaches you how it does it. Our high quality floppy disc drives are supplied with a utilities disc that includes not only the usual file handling and operating software, but a teaching programme for each utility as well. HAL makes it easy for you to upgrade and teaches you how to get the best from your system.

Plus a full line of BBC compatible products

100 CPS Matrix Printers HIGH QUALITY	Nashua Floppy Discs	Monitors-Monochrome																		
 <p>£249</p>	<table border="1"> <thead> <tr> <th>Reference</th> <th>Description</th> <th>Price per 10</th> </tr> </thead> <tbody> <tr> <td>MD1</td> <td>SSSD</td> <td>21.30</td> </tr> <tr> <td>MD1D</td> <td>SSDD</td> <td>22.75</td> </tr> <tr> <td>MD-2D</td> <td>DSDD</td> <td>26.95</td> </tr> <tr> <td>MD-1F</td> <td>SSDD ^{96 TP1}</td> <td>30.05</td> </tr> <tr> <td>MD-2F</td> <td>DSDD ^{96 TP1}</td> <td>31.25</td> </tr> </tbody> </table>	Reference	Description	Price per 10	MD1	SSSD	21.30	MD1D	SSDD	22.75	MD-2D	DSDD	26.95	MD-1F	SSDD ^{96 TP1}	30.05	MD-2F	DSDD ^{96 TP1}	31.25	 <p>£99</p>
	Reference	Description	Price per 10																	
MD1	SSSD	21.30																		
MD1D	SSDD	22.75																		
MD-2D	DSDD	26.95																		
MD-1F	SSDD ^{96 TP1}	30.05																		
MD-2F	DSDD ^{96 TP1}	31.25																		
LOW LOW PRICE																				



HAL Computers Limited,
Invincible Road, Farnborough,
Hants. GU14 7QU
Telephone: (0252) 517171

To HAL Computers, Invincible Road, Farnborough, Hants. GU14 7QU
Please send me:

Quantity		Delivery & VAT	Total	
	Sweet-P Plotters plus support pack & software at	£575.00	£96.00	£671.00
	*200K double-sided disc drives at	£216.00	£42.20	£258.20
	KDC FT 5001 Matrix printers at	£249.00	£47.15	£296.15
	TECO Monochrome monitors at	£99.00	£24.65	£123.65
	Nashua model diskettes at £..... per box of 10 + 60p per box postage & VAT			

Free details on HAL's BBC Micro compatible products plus a commemorative Schneider Trophy winner's poster. Please Tick ^{*Other capacities also available}
I enclose a cheque for £ _____ or debit my Access Account No: _____

Name _____ Address _____
Tel. _____ Signature. _____

Computerama

the source

ROM SOFTWARE	INC VAT
Wordwise	39.95
View	59.00
Printmaster	32.95
Caretaker	32.95
Disc Doctor	32.95
Terms (terminal emulator)	32.95
Graphics Extension	32.95
DFS: The Upgrade	27.95
Acorn Speech System Upgrade	55.00
HCCS Forth	39.95
HCCS Logo Forth	67.85
HCCS Pascal	57.00
HCCS Excal	74.75
ROM Expansion Board (ATPL) The Best!	43.70
Starbase	69.00
Multiforth/83	51.75
Delux Version (inc. Disc)	92.00
Toolkit	27.00
Toolstar	32.95
Commstar	32.95

BOOKS	NO VAT
BBC Micro Disc Companion	7.95
Creative Graphics	7.50
Graphs & Charts	7.50
Lisp Manual	7.50
Forth Manual	7.50
BCPL Manual	15.00
Discovering BBC Micro Machine Code	6.95
BBC Micro Disk Manual Disk Systems For The BBC Micro	1.95

MICRO POWER C/D	INC VAT
Killer Gorilla	6.95/9.95
Cybertron Mission	6.95/9.95
Cosmic Combat	6.95/9.95
Chess B	6.95/9.95
Danger UXB	6.95/9.95
Escape Moonbase Alpha	6.95/9.95
Felix in Factory	6.95/9.95
Felix & Fruit Monsters	6.95/9.95
Nemesis	6.95/9.95
Bumble Bee	6.95/9.95
Wizards Challenge	6.95/9.95
Jet Power Jack	6.95/9.95
Positron	6.95/9.95
Demon Decorator	6.95/9.95
Alien Swirl	6.95/9.95
Alien Destroyers	6.95/9.95
Space Jailor	6.95/9.95
Ghouls	6.95/9.95
Moon Raider	6.95/9.95
The Mine	6.95/9.95
Hell Driver	6.95/9.95
Labyrinths of LaCoshe	6.95/9.95
Zam	6.95/9.95
Blockbuster	6.95/9.95
Rubble Trouble	6.95/9.95
Frenzy	6.95/9.95
Stock Car	6.95/9.95
Dune Rider	6.95/9.95
Felix Meets the Evil Weirids	6.95/9.95

SOFTWARE	INC VAT
Hunchback	7.95
Overdrive	7.95
Battletank	7.95
Cosmic Kidnap	7.95
Star Battle	7.95
Moon Mission	7.95
Percy Penguin	7.95
Boris in The Underworld	7.95
Rocky	7.95
Spitfire Command	7.95
Crazy Painter	7.95
Road Racer	7.95
Mr Whizz	7.95
Wallaby	7.95
Smash and Grab	7.95
Starstriker	7.95

BUG-BYTE	INC VAT
Twin Kingdom Valley	9.95

DYNABYTE	INC VAT
Horsrace	7.95
Lemming Syndrome	7.95
Corporate Climber	7.95

BBC/ACORNSOFT	INC VAT
Algebraic Manipulation	9.95
Business Games	9.95
Castle of Riddles	9.95
Creative Graphics	9.95
Countdown to Doom	9.95
Forth	16.85
Graphs & Charts	9.95
Hopper	9.95
Lisp	16.85
BCPL (Rom + Disc)	99.95
Missile Base	9.95
Meteors	9.95
Kingdom Of Hamil	9.95
Monsters	9.95
Planetoid	9.95
Rocket Raid	9.95
Snooker	9.95
Sphinx Adventure	9.95
Starship Command	9.95
Tree of Knowledge	9.95
Snapper	9.95
Shirley Conran's Magic Garden	9.95
Personal Money Management	9.95
Draughts and Reversi	9.95
Avatar C/D	14.95/17.25
J C B Digger	9.95
Free Fall	9.95
Carousell	9.95
Drogna	9.95
Volcano	9.95
Tetrapod	9.95
S. Pascal	9.95
Ultra Calc	19.50
Gateway to Karos	69.00
Carousel	9.95
Elite C/D	14.95/17.95

ACORNSOFT EDUCATIONAL SOFTWARE NOW AVAILABLE	INC VAT
White Knight II	11.50
Vutype	16.10
Tax Calc	17.25
Beyond Basic	11.50
Toolbox	21.00
Canyon	10.00
Record Keeper	15.00

ACORNSOFT MIRLE NOW IN STOCK P.O.A	INC VAT
Eagles Wing	7.95
Spooks and Spiders	7.95
3-D Bomb Alley	7.95
Gunsmoke	7.95
Vortex	7.95
Attack on Alpha Centauri	7.95
Superpool	7.95
Starmaze	7.95

COMPUTERAMA SOLID STATE JOYSTICK INTERFACE
* with RAPID-FIRE feature
Now a totally new concept in joystick control for your BBC Micro. Simply plug into the analogue port, and connect ANY Atari type joystick for instant joystick control. FREE keyboard conversion programme allows joystick control of keyboard-only games. No memory-conflicts with this one - due to our unique Relocatable Code feature. ORDER TODAY. Only a few available. Demand is bound to be high ONLY

£14.95 + 50p Carriage

TORCH Z80 DISC PACK WITH OVER £1,100 OF SOFTWARE FREE

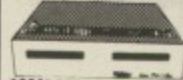

ORDER TODAY! Get the Z80 version of BBC Basic FREE (Was £125) runs BBC Micro programmes up to twice as fast gives 32k for graphics AND 48k for basic programmes

NOW ONLY **£189**

INC VAT Free Carriage UK only Software includes:
● PERFECT WRITER ● PERFECT SPELLER ● PERFECT CALC ● PERFECT FILER ● TORCH NET

The TORCH Z80 DISC PACK is the most powerful BBC Micro disc upgrade available. It provides 800k of storage plus a Z80 Second Processor running Torch's own CP/M compatible operating system. Clip this ad to your order to receive free 40/80 converter programme.

● NEW TORCH ZEPHYRUS Pack. Add Torch Power to any 80 track drives. Complete 2nd Processor AND Free Perfect software worth £11000 ONLY

£343 inc VAT



JUKI 6100 DAISYWHEEL PRINTER SAVE OVER £130

FREE 10 Ribbons
FREE Printer Cable
FREE Paper

These items Alone could cost over £80 Elsewhere.

COMPLETE PACKAGE Worth £535
COMPUTERAMA PRICE **£399** ONLY

RING FOR LATEST PRICES. MANY REDUCTIONS EXPECTED

QUICKSHOT II BBC MICRO JOYSTICK

Now with rapid fire Option and Solid State Interface. Optional Relocatable code feature - means that it WORKS with more games than any other similar interface. This SELF-CENTERING JOYSTICK, works even with keyboard-only programmes. A sensation at the Micro User Show. More fun - reaches the games other joysticks cannot. Limited supplies of this item.

£19.95 + £1.55 p&p

WE ACCEPT INSTITUTIONAL EDUCATIONAL ORDERS

ATPL SIDEWISE ROM EXPANSION BOARD

- Full sideways Rom
- Expansion to 16 Roms
- 16K Battery backed
- CMOS Ram option
- No soldering required to fit sideways
- Plug-in-and-go
- construction - Mounts neatly inside the BBC Micro
- Full buffering of address and data buses - prevents data bus loading problems associated with unbuffered boards
- Pin 1 of on-board sockets are connected properly - No spurious crashes due to this known fault on BBC Micro. Existing sockets on BBC Micro are usable. All Eprom sockets are accessible without removing sideways.



ONLY **£43.70** + £1.00 carriage

24 HOUR DESPATCH ON STOCK ITEMS

MAIL ORDER No Stamp Required
Post your order today to
COMPUTERAMA
DEPT MU11 FREEPOST
STAFFORD ST16 2BR
OR TELEPHONE OUR MAIL
ORDER HOT LINE With your
ACCESS or VISA number, we will endeavour
to despatch immediately. (0785) 41899.

Call in today - Home Computer Centre for the BBC Micro enthusiast
Send large SAE for further details of any product
CARRIAGE
UK Mainland free. Large items, Micros, Monitors, Disc Drives, Printers £8/item.

50p MONEY SAVER!
FREE with every order, five pounds worth of moneysaving vouchers

HARDWARE CORNER

BBC	INC VAT
Acorn Electron	199.00
+ 1 Electron Interface	59.95
BBC Model B	399.00
BBC Model + DOS	469.00
BBC Micro Disc Upgrade	P.O.A.
BBC Micro A-B Full Upgrade	95.00
BBC Micro Teletext Receive	225.00
BBC Micro Z80 2nd Processor	399.00
BBC Micro 6502 2nd Processor	199.00
Torch Graduate	P.O.A.
Torch Unicorn	P.O.A.
Opus D/D DFS	129.95

DISC DRIVES	INC VAT
LVL Dual 100K	340.00
Pace Single 100K	169.95
Pace Single 40/80T D/Sided	282.90
Pace Dual 100K	338.00
Pace Dual 40/80T D/Sided	573.95
Torch Dual 400K Z80 Disc Pack	799.00
Pace 200K 40T D/Sided	243.00
HOBBIT FLOPPY DRIVES	99.95
Torch Dual 400K Z80 Disc Pack	789.00

PRINTERS	INC VAT
Epson FX80	269.00
Epson RX80FT	299.00
Epson FX100	389.00
Epson FX100	569.00
Shinwa CP80	229.00
Riteman	286.00
Juki 6100 Daisywheel	399.00

MONITORS	INC VAT
Microvtec 14" Colour	229.00
Zenith 12" Green/Amber	114.95
Fidelity 14" Colour Monitor	199.00
Decca 14" colour TV/Monitor	263.00
Philips 12" Green	89.00

MISCELLANEOUS	INC VAT
Sanyo DR101 Data Recorder	39.95
Sanyo DR202 Data Recorder	44.95
Cassette leads - all types	2.80
Computerama Joystick interface	14.95
Quickshot Joystick (FOR BBC MICRO)	19.95
Printer Cable (Parallel) 1-2 m	9.95
BBC Micro Deluxe Cover	5.95
Light Pen	28.75
Data Cassettes 5 x C20/C15	1.95
The Plug Power Filter	14.95

VISIONS	INC VAT
Snooker	7.95
Digger	7.95
Daredevil Dennis	7.95
Nifty Lifty	7.95
Demolator	7.95
Pengi	7.95
Galaxy Raider	5.50

PSION	INC VAT
Saloon Sally	6.95
VuCalc	14.95
VuFile	14.95

MELBOURNE HOUSE	INC VAT
The Hobbit	14.95
A Guide to Playing The Hobbit	4.95

CLARES	INC VAT
B-Base	25.00
Replica II (Disc Only)	12.00
Graph Disc	12.95
The Key (Disc Only)	12.95
Shadow/Inspector	7.95
State 40/80T for Discs	7.95

DR SOFT	INC VAT
747 Flight Simulator	8.95
Gorph	7.95
3D Convoy	7.95
Jump Jet	7.95

AMCOM	INC VAT
Fortress (C/D)	7.95/11.95
Space Highway	7.95

ADVENTURE INTERNATIONAL	INC VAT
The Hulk	9.95
Adventureland	9.95
Voodoo Castle	9.95
Secret Mission	9.95
Pirate Adventure	9.95

ALLIGATA	INC VAT
Spitfire C/D	7.95/11.95
Neanderthal Man C/D	7.95/11.95
Blogger C/D	7.95/11.95
Uncle Claude C/D	7.95/11.95
Son of Blogger C/D	7.95/11.95
Tarzan C/D	7.95/11.95

HEWSON	INC VAT
Heathrow Air Traffic Control	7.95

A&F	INC VAT
Chuckie Egg	7.90
Cylon Attack	7.90
180! Darts	7.90
Copter Capers	6.90
Haunted Abbey	7.90

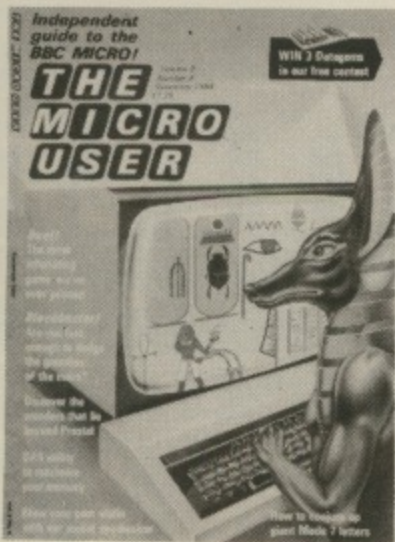

Vol. 2 No. 9 Nov 1984

Managing Editor
Derek Meakin

Features Editor
Mike Bibby

Production Editor
Peter Glover

Layout Design
Heather Sheldrick

Associate Editor
Alan McLachlan

News Editor
Mike Cowley

Technical Editor
Mike Cook

Advertisement Manager
John Riding

Advertising Sales
Mike Hayes
Margaret Clarke

Editor in Chief,
Database Publications
Peter Brameld

Tel: 061-456 8383 (Editorial)
061-456 8500 (Advertising)
061-480 0171 (Subscriptions)
Telex: 667664 SHARET G
Prestel Mailbox: 614568383

Published by:
Database Publications Ltd,
Europa House, 68 Chester Road,
Hazel Grove, Stockport SK7 5NY.

Subscription rates for
12 issues, post free:
£15 - UK
£15 - Eire (IR £18)
£20 - Rest of world
(surface)
£65 - Rest of world
(airmail)

ABC Member of Audit
Bureau of Circulations

The Micro User welcomes program listings and articles for publication. Material should be typed or computer-printed, and preferably double-spaced. Program listings should be accompanied by cassette tape or disc. Please enclose a stamped, self-addressed envelope, otherwise the return of material cannot be guaranteed. Contributions accepted for publication will be on an all-rights basis.

© 1984 Database Publications Ltd. No material may be reproduced in whole or in part without written permission. While every care is taken, the publishers cannot be held legally responsible for any errors in articles, listings or advertisements.

The Micro User is an independent publication and neither the BBC nor Acorn Computers Ltd are responsible for any of the articles in this issue or for any of the opinions expressed.

News trade distribution:
Europress Sales and Distribution Limited,
11 Brighton Road, Crawley, West Sussex
RH10 6AF. Circulation 0293 27053.

NEWS

25

Keep in touch with the latest happenings in the bustling world of the BBC Micro.

BEGINNERS

35

We take a look at the RND function and make a start on writing structured programs.

SOFTWARE SCENE

47

The latest software releases assessed by our team of frank and thorough reviewers.

DISC LOADER

62

A superb disc utility that allows large programs to be loaded directly to &E00.

PROBLEM PAGE

71

Mike Cook explains the things you've always wanted to know but been afraid to ask.

TELETEXT PLUS

76

Larger character sets are now feasible in Mode 7 with these easy-to-use techniques.

ADVENTURES

80

Our forthright columnist takes her usual critical look at the world of adventures.

BODY BUILDING

105

Ever heard a violin blown? You will, plus other wonders, with our D/A sound synthesiser.

HARDWARE SCENE

120

We compare two double density DFS systems and take a look at a sideways ROM Box.

CLASSROOM CORNER

128

Enjoyment and learning for young readers as they use simple words to create a seascape.



The cla...
game...
two pl...
its high...
paced...
will ke...
enthra...
Page

THE MICRO USER

presents two great games

BLOCK BUSTER



There's an intriguing blend of speed and strategy in this game of relentless pursuit.

Page 100

DUEL!

The classic game for two players, its high-paced action will keep you enthralled.

Page 84



135 SECOND PROCESSOR

By cunning use of macros, we present a full implementation of the 65C02's extra opcodes.

147 COMPETITION

Decide what the twins are saying to each other and win the latest database ROM.

148 SHOWTIME

All about our next big show at Alexandra Palace from October 25 to 28.

151 BEYOND PRESTEL

The comms world is bigger than Prestel. We show you just some of its huge potential.

154 BINARY BEACONS

If packet switched systems and network topologies are mysteries to you, read on . . .

156 MICROTERMINAL

We delve into assembly language and use it to improve our communications software.

159 LOGGING ON

Once you're on Microweb, you'll want to peruse the message boards - here's how.

191 MICROMAIL

A selection from the hundreds of lively letters you send us - keep them coming!

196 FAINT-HEARTED

While A. practices campanology, Bob takes up speleology and enters the Perilous Pot.

207 MAIL ORDER OFFERS

Back issues to binders, cassettes to cases, discs to dust covers - they're all here.

mixed moods

two amazing new games

from Software Invasion...

3D Grand Prix

Software Invasion games are available from WH SMITH, HMV, all SPECTRUM SHOPS and over 1,000 retail outlets.



This is the game you've been waiting for! A 3D high speed formula 1 car race round 8 different international circuits.

Just look at these amazing features:-

- * Bends arranged to simulate 8 actual Grand Prix circuits.
- * Working cockpit - Rev. counter, Speedometer, Temperature Gauge, gears, moving steering wheel.
- * Other cars which alter in perspective and size as they overtake. * Signposts. * Realistic sound effects such as engine noise, skids and crunching shunts. * Keyboard or Joystick control. * Volume control.

Runs on O.S. 1.0 or greater. More than a year of man hours have gone into creating this superb game.

BBC MICRO MODEL B

£9.95 CASSETTE

£11.95 DISK

Authors: Mick O'Neill and Dave Mendes

Blitzkrieg is a 3D Tank Battle from the same author as our Best Seller "3D Bomb Alley".

This program is probably unique in the fact that all the graphics were created with the help of models, a video camera, a video digitiser and some very special Light Pen software.

This has resulted in extremely fine detail and realism, with fast moving real time graphics - you don't have to wait for the screen to be updated between each move.

Features include:-

- * Detailed scrolling landscape. * Rotating tanks.
- * Detailed explosions. * 3D shell movement. * Recoiling barrel. * 3D sound. * Keyboard/Joystick option.

* Freeze game facility.

* Optional sound.

* Demo' mode.

* High score & ranking system.

BBC MICRO MODEL B

£7.95 CASSETTE

£9.95 DISK

Author: Simon Vout.

Blitzkrieg



NOW WITH COLOUR GRAPHICS! (BBC VERSION ONLY)

SOFTWARE INVASION



50 Elborough Street, Southfields, London SW18 5DN

Do you write your own programs? If you have an unusual program which can meet our standards you could be earning a substantial sum every week! Why not take advantage of our sought after reputation. Write now!

other SOFTWARE INVASION GAMES... send for full list now!

HOW TO ORDER

You may purchase any of the games above direct. All you have to do is write your name and address on a piece of paper, item(s) required, enclosing your cheque/P.O. made payable to SOFTWARE INVASION.

Please allow 7 to 14 days for delivery (orders are normally dispatched within 48 hours!)

OVERSEAS ORDERS. Please add £1.00 per game

DISTRIBUTORS, MULTIPLE STORES, RETAILER GROUP AND EXPORT INQUIRIES INVITE



Soft
55
Ch
Bud

The best software store in the country
(now boasting over 2,500 good titles in stock)
with accessories, joysticks and books. We have
somehow made room for hardware stocks.
Home computers, disc drives, printers, monitors,
and now a very special offer

SONY[®] R.G.B. MONITOR*

Ideal for BBC/Electron and many others.

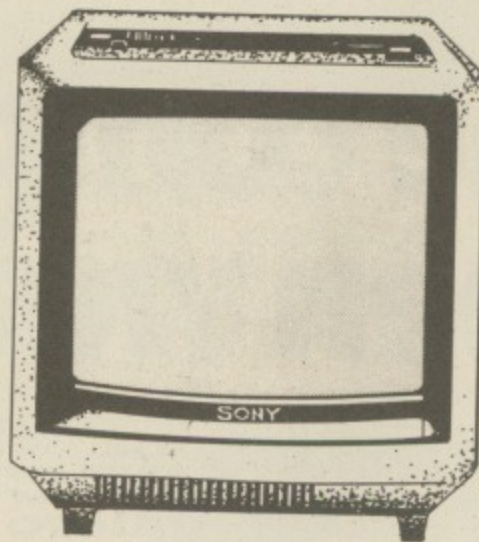

- * 14" colour monitors
- * Resolution equivalent to 480 x 400 pixels
- * Full 12 month guarantee

* These monitors using Trinitron tubes have been converted to RGB

Our unbeatable price

£149.50

 inc. VAT.

Or mail order £159.50 including VAT, p&p & BBC leads
Postal and telephone orders welcomed.

All major credit cards accepted.
(Offer subject to availability)

Soft Shop Ltd.
55 St Peter's Court
Chalfont St Peter
Bucks. SL9 9QQ

Tel: (0753) 889010

Easy Road Access
Free Parking and
Open Mon. — Sat.
9.00–5.30
Sun. 9.30 - 12.30

1st London

BARGAINS GALORE

MICROMARKET

WEMBLEY CONFERENCE CENTRE NOV. 10TH & 11TH

Here's your chance to sweep up all your Microcomputer needs before Christmas, at London's first ever Micro Market.

- ★ Thousands of Hardware & Software Bargains!
- ★ Competitions and Prizes
- ★ Win a Personal Computer!
- ★ Bring & Buy Swap Shop!
- ★ Free Computer advice at our Computer Surgery

All leading makes of Micro including:

- ★ BBC
- ★ Commodore
- ★ Apple
- ★ Spectrum
- ★ QL
- ★ Oric
- ★ Printers
- ★ Peripherals
- ★ Joy Sticks
- ★ DIY Robots
- ★ Modems

OPEN 10am-6pm Sat. November 10th
10am-4pm Sun. November 11th

Adults £1.50 Under 14's 75p.
Including **FREE**
SHOW GUIDE

MICROCOMPUTER BARGAINS GALORE, LOWEST PRICES IN TOWN, DON'T MISS IT!!!

What the competition hasn't been waiting for.

Latest version of Forth for the BBC (Is not rehashed Forth 79 Code)

Unique Stack Display Utility



16k Eprom type 27128

Multi-tasking operating system for Real-Time use.

Here's the Forth Eprom for the BBC Micro that makes all others out of date.

It's Multi-Forth 83 from David Husband who has built his reputation for Quality Forth products with his ZX81-Forth ROM, Spectrum Forth-I/O Cartridge and now New Multi-Forth 83 for the BBC Micro. This is not rehashed Forth 79 Code, but a completely new version of the Forth 83 Standard. It's unique in that it Multi-tasks, and therefore the user can have a number of Forth programs executing simultaneously and transparently of each other.

Multi-Forth 83 sits in the sideways ROM area of the BBC along with any other ROMs in use. It is compatible with the MOS, and specially vectored to enable a system to be reconfigured. It contains a Standard 6502 Assembler, a Standard Screen Editor, and a Unique Stack Display Utility.

With this Forth, David Husband has provided the BBC Micro with capabilities never before realised. And being 16K rather than 8K is twice the size of other versions. Multi-Forth 83 is supplied with an

extensive Manual (170 pages plus) and at £40+VAT it is superb value.

Order it using the coupon adding £2.30 p&p (£5 for Europe, £10 outside) or if you want more information, tick that box instead. Either way, it will put you one step ahead of the competition.

Please send me Multi-Forth 83 for BBC Micro. £40+VAT. De-luxe System inc. Disc £80+VAT. Cheques to Skywave Software Readers' A/C (or enter Visa No.)

BMU/11  

Name _____

Address _____

Post code _____

Please send me more information:

Multi-Forth 83

ZX81-Forth ROM.

Spectrum Forth-I/O Cartridge

Skywave SOFTWARE

SUBJECT TO AVAILABILITY. FOR I.O.S. ONWARDS.
Send to Skywave Software, 73 Curzon Road, Bournemouth, BH1 4PW, Dorset, England. Tel: (0202) 302385

MULTI-FORTH 83 FOR THE BBC MICRO

Outstanding Modem WS2000

the only modem you'll ever need to buy.

WS2000 brings 1990's modem technology to you NOW! Link across the world — your computer to mainframes, to Prestel, Micronet, Easylink Telex, Telecom Gold, to other computer users anywhere.

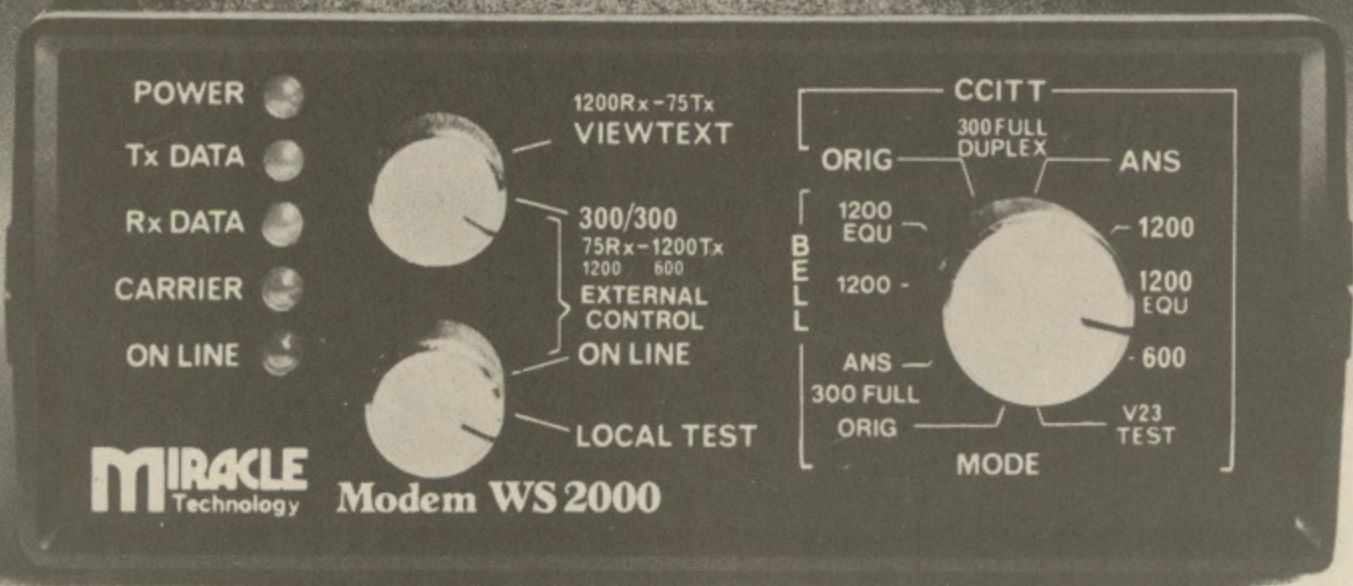

Trade enquiries invited

Software packages

Off-the-shelf dedicated software packs for most major computers: DataTalk for IBM PC/PCXT, VICOM for colour Prestel plus bulletin boards on Apple, many packages for BBC, Commodore and other computers. WS2000 covers the field.

Satisfied Users

"This modem is so simple to use." — Miss VAB of Bristol.

"It's got every feature we need — even telex use." — Company director Mr JLK of Wigan.

"What a wonderful machine! Its operation is quite faultless." — Mr CJC of Beaconsfield.

Enthusiastic Press

"The best value for money in the modem field." Quentin Reidford, APPLE USER.

"Very versatile; good value." Peter Tootill, PCW.

"Could turn out to be the peripheral you can't live without." Ralph Bancroft, PCN.

Expansion Accessories

WS2000 can grow to suit your needs! The modem's unique User Port lets a computer access all the modem's functions — full software control is possible. Auto answer and auto dial plug-in accessories let your computer accept and initiate telephone calls. TTL interfacing, acoustic coupling, battery back-up, process control interfacing — they're all possible for the WS2000 owner.

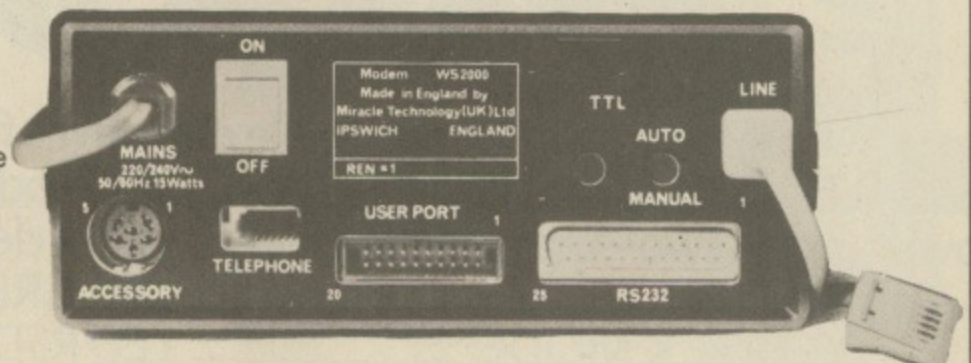

still only £129.95 exc.

WS2000 complete with BT modular line plug and socket and full instructions for use — £152.50 inc VAT and P/P.

Miracle Technology (UK) Limited
10/12 St Peters Street
Ipswich IP1 1CK
Tel (0473) 50304

Reg in Eng No 1756137

BABT approval pending.

Order by cheque/Barclaycard/Access/Official order to

MIRACLE
TECHNOLOGY(U.K.)LTD.

CHASE DATA

PRICES SENSATION

Canon 110: Case/Cables all INCL **£99**

Canon 220: 400K (40/80 switching)

Case/Cables all INCL **£169**

N.B. These are state of the Art Disc Drives; Direct Drive
40 track 6mms Access/80 track 3ms Access.

**DFS Kits available
ex stock
all inclusive price £109**

SLIM CANON DISC DRIVES:

MODEL: SPECIFICATION OF EACH DRIVE

110	S/SIDED 40 TRACK 100K
210	D/SIDED 40 TRACK 200K
220	D/SIDED 80 TRACK 400K (40/80 TRACK SWITCHING)

■ All **CANON** 40/80 switchable disc drives feature an on-board dual-colour LED on the front panel to show track mode selected. This is coupled with our own unique two-stage illumination, to give a clear operating status, as follows:

40 TRACK MODE: _____ LED GREEN

80 TRACK MODE: _____ LED RED

POWER ON: _____ HALF-ILLUMINATION (GREEN OR RED)

DRIVE SELECTED _____ FULL-ILLUMINATION (GREEN OR RED)

■ Super-slim **CANON** drives, models 211 and 221 and the **SANYO** model 596D are available with their own **custom-built secondary switching power supply**. This is safe, low in heat generation and excellent value for money.

■ The **SANYO** disc drive is our latest acquisition in quality Japanese products. This is a "half-height" unit of standard dimensions.

LTD DISC DRIVES

**FOR THE
BBC
MICRO**

SLIM SANYO DISC DRIVES:

MODEL: SPECIFICATION OF EACH DRIVE
596D D/SIDED 40/80 TRACK 400K

SUPER-SLIM CANON DISC DRIVES:

MODEL: SPECIFICATION OF EACH DRIVE
211 D/SIDED 40 TRACK 200K
221 D/SIDED 80 TRACK 400K
(40/80 TRACK SWITCHING)

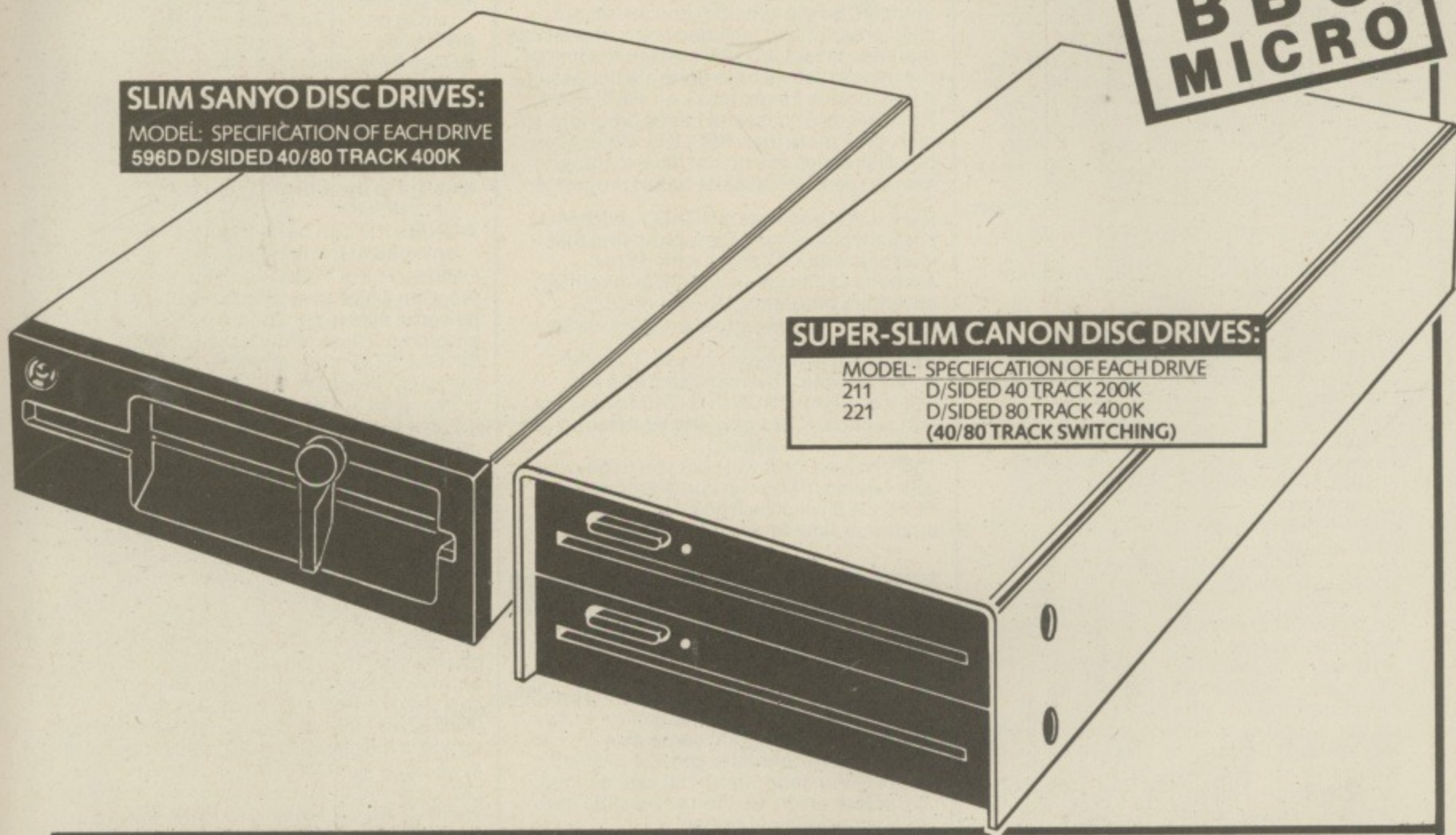

All inclusive price list:

This means: disc drive + case + all power & data cables + U.K. carriage + utilities disc & manual + V.A.T.

MODEL:	CANON					SANYO
	110	210	220	211	221	596D
Formatted Capacity per drive on BBC Micro:	100k	200k	400k	200k	400k	400K
Single Drive & Case:	£99	£139	£169	£179	£236	£182
Single Drive & Case/P. Supply:	£124	£164	£194	£209	£266	£212
Dual Drive & Case:	£204	£274	£314	£329	£437	£368
Dual Drive & Case/P. Supply:	£229	£299	£339	£359	£467	£398

Support:

Warranty: All disc drives sold by Chase Data Ltd. come with a full one-year warranty on parts & labour.

Non-warranty service: As THE experts in our field we can offer service on most makes of floppy disc drive.

Recalibration & Alignment ... £25 per unit inc. VAT. (parts extra). Phone for details: (Tel: 0784 38487)

Payment



By Post: Send your remittance (cheques only please) with your order to:

CHASE DATA LTD

P.O. Box 6, Woking, Surrey, GU21 4PB.

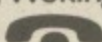
By Phone:  (Tel: 0784 38487).

CLARES NO1 UTILITY SOFTWARE!

ENHANCED

BETA-BASE £25 DISC
8 GREAT FEATURES

WHAT IS A DATABASE?

It is a FILE which contains RECORDS. Records consist of a number of FIELDS containing the information—an analogy can be drawn with a card index in which a box of cards is the file. Each card is a record and each line on the card is a field.

SPECIFICATION

- 1) Random Access—disc based, single or dual drives
- 2) File Size—99K (40 track), 199K (80 track)—65,000 + records
- 3) Record Size—up to 2048 characters and 200 fields
- 4) Field Size—up to 254 characters with complete line scanning
- 5) Access any record using Primary Key in 2 seconds
- 6) Holds—1200 NAMES AND ADDRESS records on 100K disk
- 7) Search—500 records on 5 fields in 60 seconds
- 8) Sort—500 records on 3 fields in 60 seconds

SYSTEM FEATURES

- CALCULATE—using any valid expression and store results
- POWERFUL PRINTOUT OPTION—Eliminates need for separate mailing program, Parallel/Serial Printout allows setting of printer control codes, line spacing, tabulation, Headings etc, plus label printing with horizontal and vertical tab control.
- REDEFINE—Titles, field widths, number of fields, number of records etc.
- TRANSFER—Records from one file to another.
- SEARCH LISTS—Allow creation of sub-Databases within main Database.

NEW *

- * GLOBALENTRY enables repetitive data to be typed in once and placed in as many records as required. Can also be used with a search list to provide a powerful global edit/update facility that will save hours of typing.
- * SPOOLER enables you to create spooled files that are compatible with Wordwise, View and other word processors. You can therefore present your data within a document or in varying formats etc. The spooler program will allow to format your spooled file in the same way as the print out option. You can therefore have headings, columns, titles, numbers etc.
- * INPUT is a routine included on the disc which will allow you to write utilities for accessing your data and tailored specifically to your needs.
- * TUBE compatible with the 6502 second processor.
- * Comprehensive manual and tutorial. All timings and sizes are relative to ACORN DFS. Compatible with ACORN DFS, WATFORD 1.3 and latest AMCOM DFS SERIES B.
- * ORIGINAL USERS send your disc plus £3 for up grade.

REPLICA II: £12.00.

DISC

The original REPLICA set a very high standard so the specification we set our chief programmer included some impossible features. In fact ACORN state that some of the things that we have done are impossible, it just took us longer that's all. REPLICA II transfers most cassette based programs to disk, even more than REPLICA. When you buy disk drives you do not have to throw away expensive cassette based programs.

REPLICA II transfers 'LOCKED' programs, programs loading as files, programs that load below &EOO, those with up to 6 sections and those up to &6E in length eg adventure programs. No waiting for 6 minutes whilst adventure programs load.

REPLICA II is very easy to use. The user enters a name, how many sections and whether CHAIN, RUN or LOAD to load the first section. Press play and let the program do the rest, even a menu. Think how much it will cost you to buy just 1 disk version of your favourite program—REPLICA II which will hold up to 16 programs, limited only by the disk capacity.

FX 80 PRINTER DRIVER £12.00

PRINTER DRIVER FOR EPSON FX80 AND VIEW

Multi-page driver with print menu allowing the setting of global (document wide) printer functions at printer initialisation.

The print menu program contains a sophisticated character generator which allows the construction of 95 user defined characters which are then accessible from VIEW via a highlight option.

Supplied on disc with comprehensive user manual.

NEW

DISCDEX: £15.00

DISC

- Catalogues all your discs quickly and easily.
- Room to store four thousand titles.
- Quick search and load option.
- Compatible with single or dual drives.
- Extensive print options for catalogue and disc labels.
- Update and delete options.
- Supplied with stick on labels to number your discs and a supply of labels for printing your own disc labels.

DISCDEX is the answer to a disc users nightmare. How many times have you had to wade through your discs looking for the file that you know is there somewhere? Now with DISCDEX those days are gone.

DISCDEX will catalogue all your discs and store them in alphabetic order. In addition to the very useful search and load facility DISCDEX will also print out a full catalogue in alphabetic or disc order. Even more useful is the ability to print disc labels for sticking on the disc or the jacket.

DISCDEX is only suitable for discs with 31 file names as in the standard ACORN system. It is not suitable for double density interfaces.

NEW

ONESHOT: £12.00 DISC

- Full feature trace utility.
- Single step through BASIC program or halt at user determined interval.
- Print line number prior to execution.
- Obey fixed instructions before executing a line.
- Trace window allows screen to be seen whilst tracing execution.
- "Printer only" will force trace output to a printer allowing full screen display.
- Ability to dynamically alter control of ONESHOT.
- ONESHOT can be configured to run in any area of memory.

ONESHOT is a 1.25kb machine code program which gives the user several powerful aids in debugging BASIC programs. These include the ability to SINGLE STEP through the BASIC code of the target program, stopping the processing at specified points and comprehensive trace functions of the variables used by the target program.

A very powerful option allows the user to enter a command string into function key 0 and instruct ONESHOT to obey this command BEFORE each line is executed e.g. *KEY0 PRINT X%; M will print the value of X% before executing each line. This is a very simple example and it is possible to do much more complex things including printing the value of a variable only when it changes or when it reaches a certain value or falls within a certain range. This option can also be used to dynamically alter ONESHOT as it is working. The power of this option is only limited by the users ingenuity. In addition to ONESHOT the disc also contains 3 very useful function key routines. The first will search for any DEFPROC or DEFFN and print the line numbers in which they appear together with the name of the procedure or function. The second will search for a specific procedure or function and print the line numbers containing it. The third routine will print out every active variable together with its present value. ONESHOT is not compatible with double density interfaces.

NEW

FUN HOUSE: £10.00 DISC

FUN HOUSE is a highly original suite of educational programs suitable for ages 3 to 13. The program is designed to encourage children to spell words which relate to objects found around the home. Animation and music are used to good effect and some highly original ideas are incorporated. Each room exercise is terminated with a warning item e.g. the lounge finishes with 'FIRE' which goes on to engulf the whole lounge. Tests with a newly hired 4 year old resulted in us having to prise him away from the keyboard after 2 hours. In that time he had gone from never having used a keyboard to finding the location of all the keys very quickly and entering the correct answer. He had thus started on the path to learning spelling and familiarised himself with the keyboard including the use of DELETE to correct his mistakes. Can you afford not to give your children the same start?

FUN HOUSE is not compatible with double density interfaces.

clares
MICRO SUPPLIES

Send for detailed newsletter.
All prices inclusive of VAT & Carriage—
NO EXTRAS! Please state 40 or 80 track disc
98 Middlewich Rd.,
Northwich, Cheshire CW9 7DA.
Tel: 0606 48511
Open 9—5pm Monday—Friday

All Disc Software now
available on 3" disc—
add £3 to printed prices

C

g
a

g
ce
et

e

3

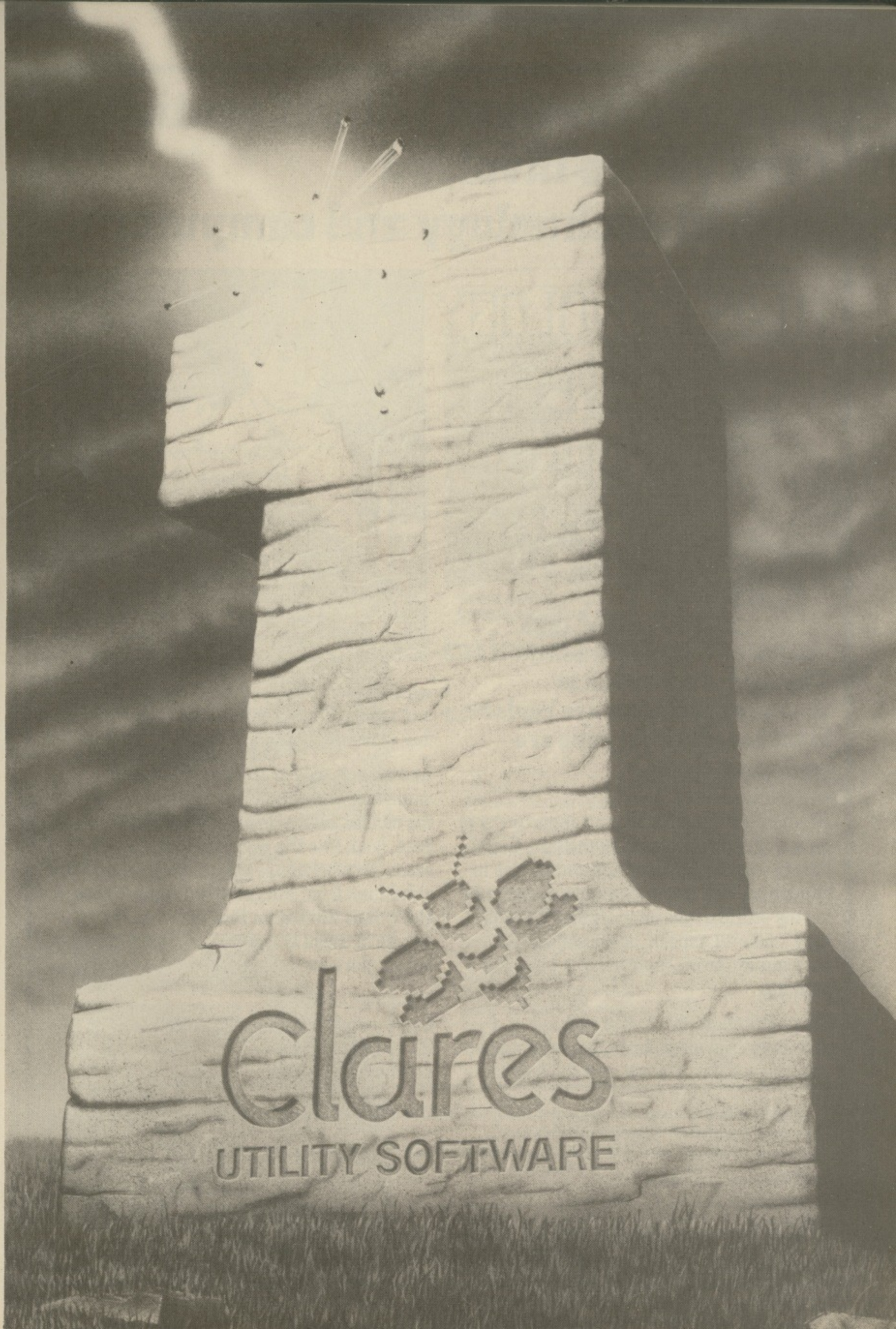

Clares
UTILITY SOFTWARE

**If you're involved with education,
then you're involved
with hi-technology and computers.**

**THE
HI-TECHNOLOGY
AND
COMPUTERS
IN
EDUCATION**

Exhibition

**23-26 January, 1985
BARBICAN CENTRE, LONDON EC2**

**The face of education is
changing, monitors are replacing
blackboards, light pens are
replacing chalk.**

As an educationalist take an opportunity to get right up to date with everything that's new in high technology and computers in education. The new techniques aren't only for the science labs or computer classes, they cover all aspects of the schools curriculum, from geography to physical training.

This exhibition, the first of its kind, is a definitive showcase for both manufacturers and users alike. You can see the best the



world has to offer, compare specifications and collect literature away from the bustle of day to day activities.

Entrance is free to anyone working in education and over 18 years of age. Just clip the coupon below. (To be completely up-to-date, book into the series of half-day seminar/workshops organised alongside the exhibition in co-operation with the Micro-electronics Education Programme. For details of these and a booking form, tick the box on the coupon below.)

Timothy Collins,
Computer Marketplace (Exhibitions) Ltd.,
20 Orange Street,
London WC2H 7ED

To: Timothy Collins, Computer Marketplace (Exhibitions) Ltd 20 Orange Street, London WC2H 7ED.

Please send me details of the seminar/workshops

Please send me my free ticket(s) to the Hi-Technology and Computers In Education Exhibition,

Quantity _____ Name _____

Establishment _____

Address _____

Postcode _____

Telephone _____

For details
of discount rail
travel: P.O. Box 1,
St. Albans AL1 4ED
Telephone (0727)
37799

mw systems

SUMMER SPECIAL OFFERS



ONLY
£330

MWS 800K (1.6MB) at Double Density.
DUAL DRIVES from TOSHIBA.
These drives are double sided/double density and are 40/80 Track Switchable.



ONLY
£200

MWS 400K (800K at Double Density).
SINGLE DRIVE from TOSHIBA.
These drives are also double sided/double density and are 40/80 Track Switchable.



ONLY
£140

NEW PRODUCT RELEASE

MWS 200K.
A SINGLE DRIVE from EPSON.
These drives are double sided/single density and are 40 Track.

mw systems ltd.

Matrix House
Lincoln Road
Cressex Industrial Est.
High Wycombe
Bucks
Tel (0494) 32751

ORDER FORM

All prices are exclusive of VAT.
Price includes Formatting Disc,
Manual and all Cables.
All units carry a one year warranty.
All units are ex stock.

Please supply the following Order

	Quantity	£	p
MWS 800K DUAL DRIVES Summer special offer price £330.00			
MWS 400K SINGLE DRIVE Summer special offer price £200.00			
MWS 200K SINGLE DRIVE Summer special offer price £140.00			
MWS 100K SINGLE DRIVE (not illustrated) Summer special offer price £135.00			
MWS Optional Power Supply £35.00			
Please debit my Access/Barclaycard/Amex/Diners	Delivery	£10.00	
	Sub Total		
Card No. <input type="text"/>	VAT 15%		
I enclose a cheque for £..... made payable to MW Systems	TOTAL		

Name _____

Address _____

Tel No. _____

PHLOOPY

A 100k BBC-drive for £99 + VAT

We've done it! We've built a mass storage system for your BBC Micro with the power and convenience of a floppy disk drive, but at a fraction the price. Get to know PHLOOPY, the remarkable new 100k drive that costs only £99 plus VAT, and a further £26 plus VAT for the interface to your BBC, operating system and connecting cables.

How PHLOOPY does it

PHLOOPY does not use disks to store data, but a 12-foot loop of professional-quality quarter-inch magnetic tape contained in a robust cartridge. The drive has only one moving part, the motor which drives the tape loop – hence the low price and high reliability. As the loop is driven round, each file of data it contains passes across the magnetic head which reads it or writes to it. Other people have produced tape loop micro-drives, but they've not been very reliable. They lacked PHLOOPY's special secret.



PHLOOPY's special secret



The heart of the invention is a brilliantly designed "byte-wide" magnetic head, made by Phi Magnetronics who build multi-track heads for professional use. PHLOOPY's head records and reads nine tracks across the width of a quarter-inch tape. That means the tape loop can be much shorter, so the typical time to access a file is reduced to a mere 3 seconds. If you're used to waiting for a cassette tape to trundle programs into your BBC, you'll be amazed at PHLOOPY's performance.

Getting it right every time

In addition, we've included a feature we know you will appreciate. PHLOOPY has full error detection and correction, so you can be certain you will get back what was originally written onto the tape.

Talking to your PHLOOPY

PHLOOPY's own software, contained in ROM, responds to standard BBC filing system and Basic commands. Most programs written to run on disk or cassette should run on PHLOOPY without problem.

And because PHLOOPY contains its own intelligent microprocessor – a second computer which does most of the hard work – PHLOOPY puts very

MAF

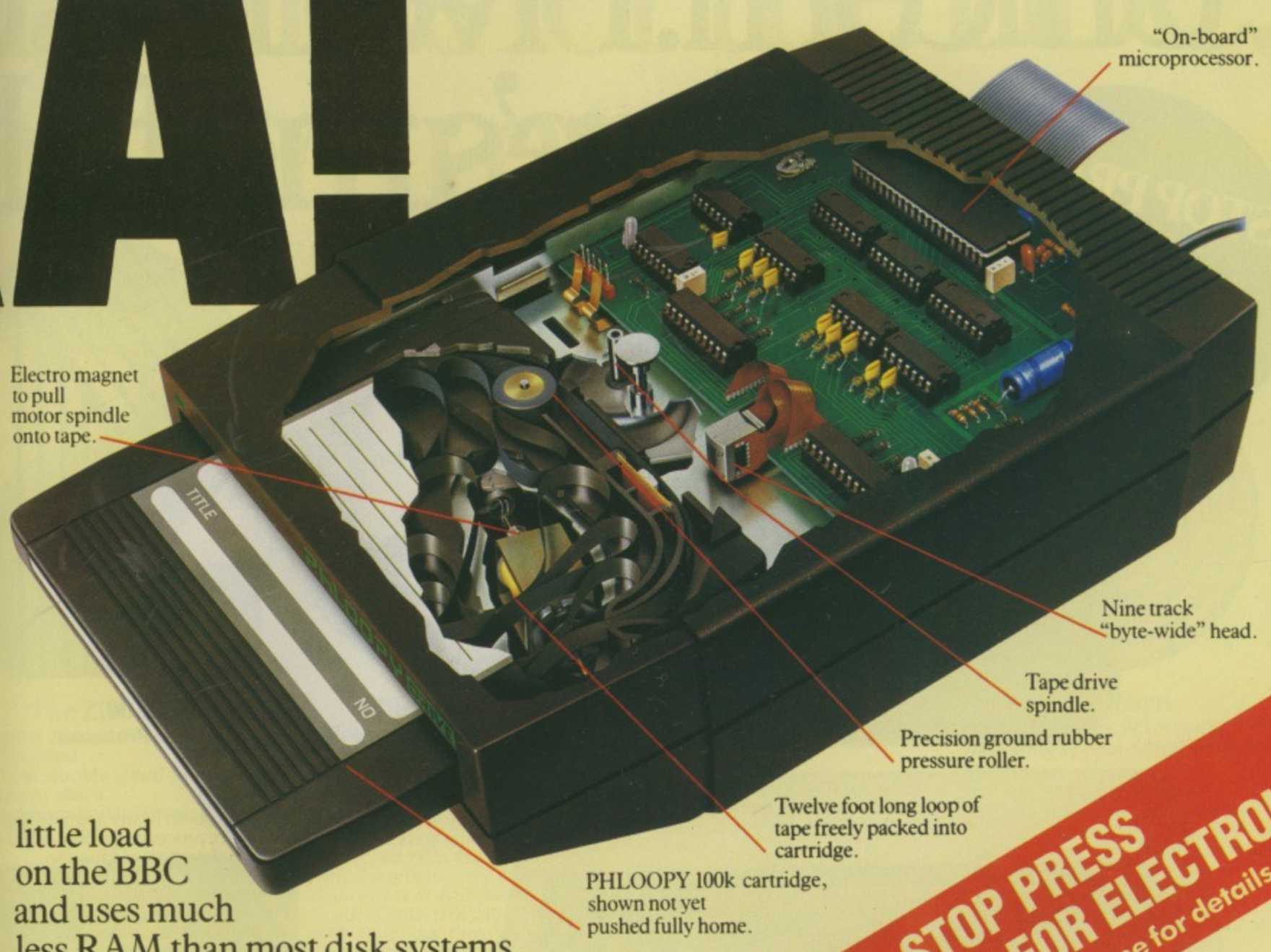

little load on the BBC and uses much less RAM than most disk systems.

Installing PHLOOPY on your BBC

You'll be amazed how simple it is to install PHLOOPY. Just plug in the interface cut two resistors (clearly marked in the instructions) and the job is done. If you should have problems our engineers are waiting to help you.

Making a PHLOOPY Library

PHLOOPY cartridges hold a full 100k of data or programs. Two of them come free with the drive and extra ones cost £3.75 each plus VAT. They are moulded of high impact polymers for protection and store easily on a bookshelf. Many programs will be available to purchase on PHLOOPY.



STOP PRESS
PHLOOPIES FOR ELECTRON!
 Send coupon or phone for details.

Order Form

- Please send me further details about the PHLOOPY 100k data storage system for the BBC Model B.
- Please send me _____ (qty) PHLOOPY starter pack(s) for my BBC Model B microcomputer, including PHLOOPY drive, BBC interface, leads, connections, operating system in firmware, manual, and two PHLOOPY 100k cartridges, at £147.75 each including VAT, postage and packing. Amount £ _____
- Please send me _____ (qty) packs of 5 PHLOOPY cartridges at £19.75 including VAT, postage and packing. Amount £ _____

I enclose a cheque/PO for £ _____ OR Please debit my Access card: Number: _____
 Your order will be acknowledged within 10 days, giving a delivery date.
 Name _____
 Address _____
 Town: _____ Post code _____ MU/NOV
 Send this coupon to:
 Phi Mag Systems Ltd, PO Box 21, Falmouth,
 Cornwall TR11 3TD. Telephone: Falmouth (0326) 76040.
 14 day money-back option.

Unicorn. Five new ones. Here's the full story.

STOP PRESS
Now
**Multi-user
UNIX on
UNICORN**

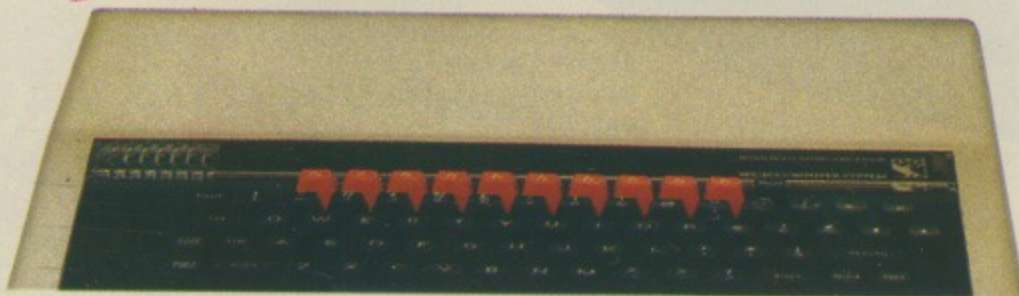

The new UNICORN range from TORCH Computers gives the enthusiast and professional user a choice of upgrades which takes the BBC Model B Micro to the ultimate height of performance.

The result of TORCH'S total commitment to the BBC Micro is the only complete range of high performance hardware available. Offering every BBC Micro owner five new upgrade channels, UNICORN will transform your BBC into a fully communicating workstation, a CP/M[®] compatible business machine or the ultimate in high powered 32-bit data processing.

At the top of the range, THE UNICORN, offers the power and sophistication of System III UNIX[®] whilst other channels make available the flexibility of languages such as FORTRAN, PASCAL, BCPL and COBOL. All models, with the exception of the HDP240, provide BBCBASIC (Z80) on the Z80 rather than the Model B's 6502.

Tune in to the Channel that most suits your requirements. Whichever level you choose you can be sure of a system with infinitely expandable potential for a confident future in the world of computing.



The ZEP 100

- Z80 Extension Processor
- 4MHz Z80A
- 64K RAM
- 24K ROM

The object of any upgrade kit is to improve processing ability and to increase data storage capacity. The UNICORN ZEP100 is the first stage upgrade which opens channels into the world of serious computing.

The ZEP100 is the proven 8 bit second processor for the BBC Model B micro. A Z80 extension processor which enables the use of the well established CPN operating system, giving access to the vast range of applications programs and languages available for all CP/M[®] micros. When fitted to a BBC model B microcomputer with compatible high quality disc drives it provides a complete business or scientific computer which can run large applications programs or use advanced languages, with the ability to switch back to standard BBC programs at any time.

Any ZEP100 can be linked, via the Econet[®] option on the BBC, to a network of other TORCH computers to provide a workstation running on TORCHNET. Full TORCHNET operating systems software is provided to allow access to information anywhere on the network, or to communicate with other computers.

The 64K ZEP100 is supplied with full software support including word processing, spreadsheet, database and utilities. **The ZEP100 around £299 (ex. VAT).**

Here's the full story.
The ZEP 100
● 4MHz Z80A
● 24K ROM
● Twin floppy
● Independent power
The UNICORN ZEP100 is the first stage upgrade which opens channels into the world of serious computing. The ZEP100 is the proven 8 bit second processor for the BBC Model B micro. A Z80 extension processor which enables the use of the well established CPN operating system, giving access to the vast range of applications programs and languages available for all CP/M[®] micros. When fitted to a BBC model B microcomputer with compatible high quality disc drives it provides a complete business or scientific computer which can run large applications programs or use advanced languages, with the ability to switch back to standard BBC programs at any time. Any ZEP100 can be linked, via the Econet[®] option on the BBC, to a network of other TORCH computers to provide a workstation running on TORCHNET. Full TORCHNET operating systems software is provided to allow access to information anywhere on the network, or to communicate with other computers. The 64K ZEP100 is supplied with full software support including word processing, spreadsheet, database and utilities. **The ZEP100 around £299 (ex. VAT).**

Open channels for the BBC. Microprogramme.



The ZDP 240

- 4MHz Z80A ● 64K RAM
- 24K ROM
- Twin, double sided 400K floppy discs
- Independent integral power supply

grade kit is
ity and to
city.

processor for the
extension
the use of
operating
the vast
ams and
CP/M®
C model B
patible high
es a
tific
rge appli-
anced
o switch
ams at

ked, via
n the
t of other
ers to
e a work-
running
RCHNET.
RCHNET
ting sys-
software
vided to
o
/where
to com-

EP100 is
a full
port
ord pro-
adsheet,
id
ZEP100-

The UNICORN ZDP240 (Torch Z80 Disc Pack) is the proven upgrade for the BBC Model B micro-computer. Offering the use of more powerful and flexible languages such as Fortran, Pascal, BCPL and Cobol, it provides 800K of disc storage plus a Z80 second processor with 64K RAM running TORCH's own CP/M® compatible operating system based in ROM.

This advanced design means that almost all of the 64K RAM provided by the Z80 board is available for CP/M® programming use - an advantage no other BBC micro upgrade can offer.

If your BBC micro has the Econet® option, there is a further benefit the ZDP240 can offer. TORCHNET can link together up to 254 upgraded Model B's on a local area network, so for enthusiasts, Clubs and Schools it is a simple and low-cost way to achieve networking facilities.

The discs can be used for storage under the Acorn DFS system or for CP/M® programs and data.

A comprehensive software package is provided with the disc pack. It includes word and data processing and a spreadsheet program, along with utility programs and manuals.

The TORCH Z80 Disc pack is recommended by the CCTA for government use. **The ZDP 240 - around £699 (ex. VAT).**

The HDP 240

- 20Mbyte hard disc Winchester
- Double sided 400K floppy disc
- Integral power supply

For users who need much more storage capacity than is available on floppy discs and who require the large speed gains that a Winchester hard disc provides, the third new channel is now available. The UNICORN HDP240 combines a 400K floppy disc drive with a 20Mb hard disc and its associated controller. The pack connects directly to the disc and 1MHz bus sockets on the BBC Model B.

In conjunction with a ZEP100, it provides a powerful business computer for running CP/M® programs with large amounts of data. The floppy disc can be used for storage with the Acorn DFS system, and both discs can be used by other TORCH systems on the TORCHNET local area network. **The HDP240 - around £1995 (ex. VAT).**

The HDP68K

- 8MHz MC68000 ● 6MHz Z80B
- 256K RAM (68000)
- 64K RAM (Z80)
- 20 Mbyte hard disc Winchester
- Double sided 400K floppy disc
- Integral power supply

The fourth channel in the UNICORN range is for users who need the extra processing power of a 68000 32 bit processor, as well as the Z80 running standard software. The UNICORN HDP68K provides the ultimate in performance, offering an extra 256K RAM and a 68000 processor running at 8 million cycles per second. It also contains a Z80 processor to allow the running of existing TORCH software.

The HDP68K - around £2495 (ex. VAT).

The Unicorn

Spec. as HDP68K PLUS UNIX® operating system. Single-user or Multi-user

UNIX® System III is the recognised operating system of the '80's. A very powerful and sophisticated multi-tasking system, it includes a vast library of utility programmes.

The fifth channel and top of the range, THE UNICORN, puts UNIX® within reach of the individual user, at a price unmatched by any other UNIX® systems, by combining the reliability of the BBC micro with advanced technology from TORCH.

TORCH UNIX operates under the network operating system. Using UNICORN products, a low-cost network of BBC Micros can be configured to offer the most complete range of educational computing facilities available anywhere.

Other facilities available include UCSDp-System, LISP, FORTH, PILOT and PROLOG. **The UNICORN - from around £2895 (ex. VAT).**



UNICORN

Open channels for the BBC micro.

To: Torch Computers Ltd., Abberley House,
Great Shelford, Cambridge CB2 5LQ.
Telephone: Cambridge (0223) 841000.

Please send further information on the UNICORN
range plus your FREE 1984 Software Catalogue.

Name _____

Address _____

Tel _____

Post Code _____



TORCH
COMPUTERS



CP/M is a registered trademark of Digital Research Inc.
Econet is a registered trademark of Acorn Computers Ltd.
Unix is a registered trademark of Bell Telephone Laboratories Inc.

UK version Model B necessary. Text and Graphics provided by BBC Model B.
Disc interfaces are necessary for use with the Unicorn range. Keyboard provided by BBC Model B.

MU11

BEEBUGSOFT

*The Name to watch for
your serious B.B.C.
and Electron
Software*

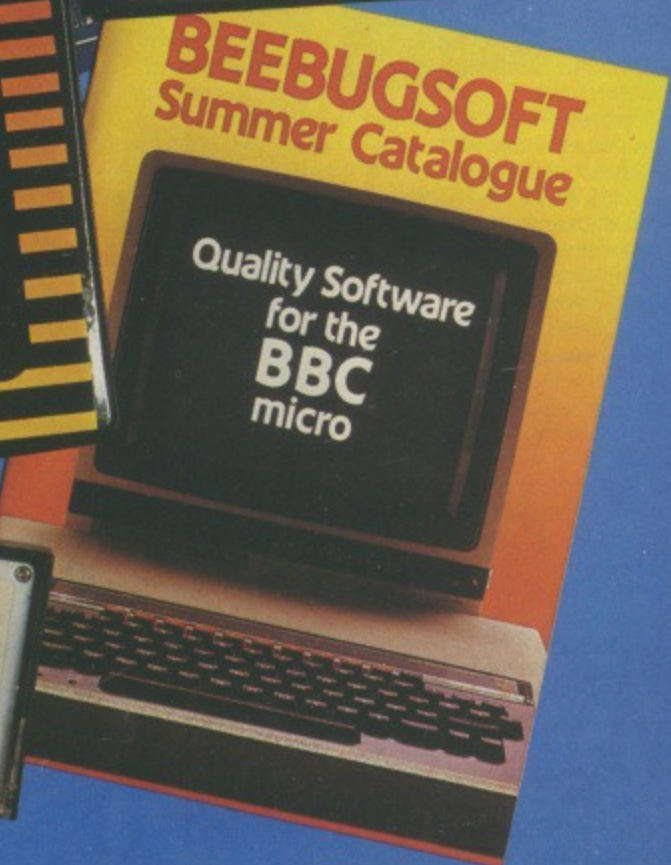
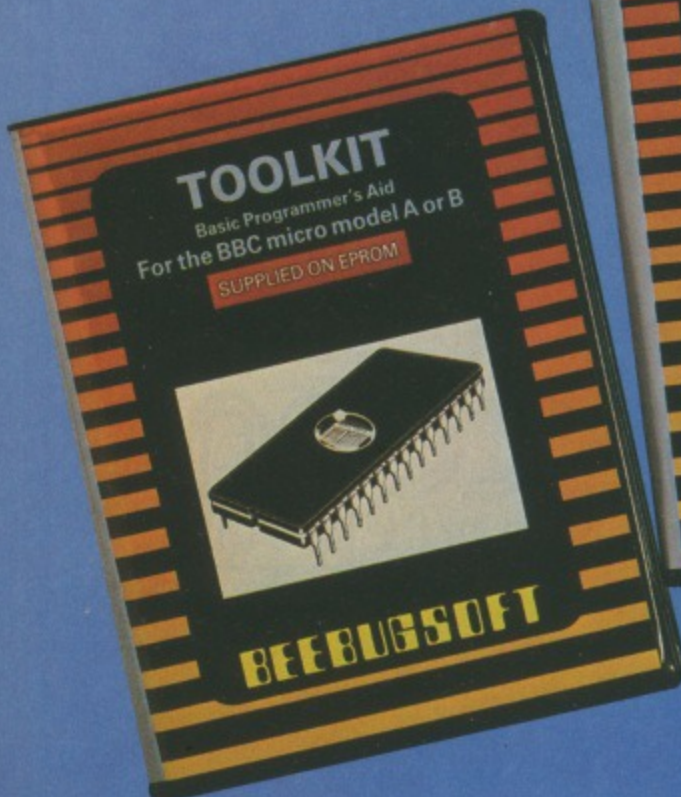
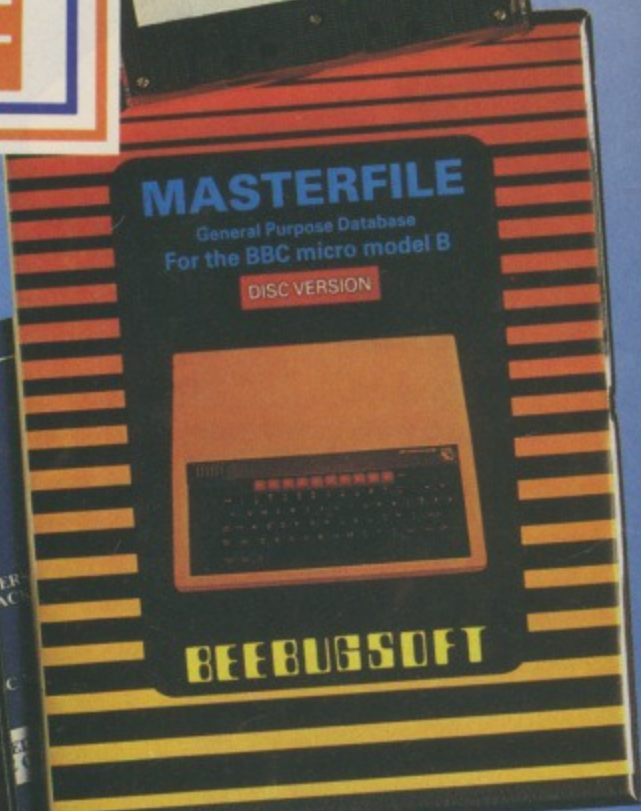

Available from your local dealer and selected branches of W.H. SMITH'S. Telephone us for a full brochure . . .
St. Albans (0727) 60263.
BEEBUGSOFT, P.O. Box 50, St. Albans, Herts.

TOOLKIT ROM from BEEBUGSOFT

BASIC Programmer's Aid for the BBC micro

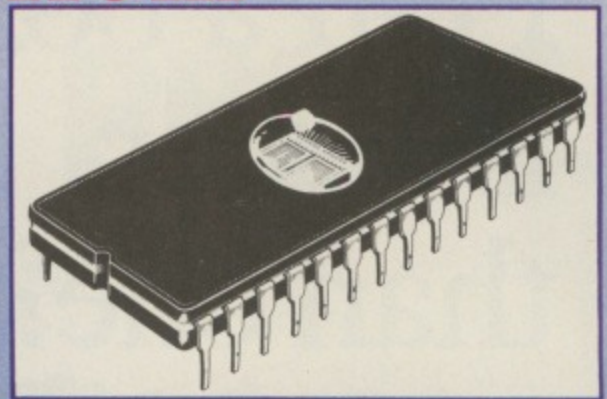

```

>HELP INFO
TOOLKIT 1.30
FX 11 9:38:00
FX 11 9:38:00
@:=&0000090A
LISTD 0 WIDTH 0
ERR 26 ERL 0
REPORT: No such variable
Free memory = 20262 bytes
Program size = 5082 bytes
Next free location = &2CDA
PAGE = &1900 LMEM = &2CDA
TOP = &2CDA HMEM = &7C00
DS 1.20
>
    
```

- 27 new commands to make life easier
- Saves hours in program development and debugging
- Supports both cassette and disc systems

- No command name conflict with other Roms
- Ideal for expert and novice alike
- Fitting instructions and a 32 page manual supplied
- You'll wonder how you ever managed without it

SPECIAL FEATURES INCLUDE

SCREEN EDITOR An extremely powerful editor, allowing the use of cursor keys to list a program line-by-line in either direction and move to any part of a program to overtype or insert new code and corrections.

```

Editing lines 0 to 1470
1 String search
2 Search and replace
3 Move lines
4 List procedures and functions
5 List A% to Z%
6 List numeric variables
7 List string variables
8 List arrays
9 Change edit range
0 Edit program

ESCAPE to exit
Enter option: 1
Search string: X%
640 DEFPROCVAL (U%, V%, W%, X%, Y%)
670 IFB%< X% A%=&U%+2:ENDPROC
1450 LOCAL X%, Y%
1460 Sbuf:=caand$ : X% =buf%:Y% =buf%DIV2
56
Enter option: -
    
```

ERROR DETECTION Powerful facility to trap an error in a Basic program as it runs. It will then automatically enter the Screen Editor, display the line in error and position the cursor close to the statement at fault.

"TOOLKIT is an essential utility for all Basic programmers using the BBC Micro... an indispensable aid packed full of powerful utilities."

EDUCATIONAL COMPUTING MARCH 1984

"... highly recommended,"
PCN MARCH 17 1984

"The Beebugsoft Toolkit costs £27 and in my opinion is worth every penny. Since it has been installed in my BBC it has been used extensively and I can find no fault with it. Highly recommended to lazy programmers!"

COMPUTING TODAY JUNE 1984

COMMANDS

- *CHECK Verify a program or data in memory with disc/cassette.
- *CLEAR Clear all variables including integers.
- *EDIT Enter full screen editor.
- *FREE Display free memory and pseudo variables.
- *HELP INFO Display a screenful of useful system information.
- *MEMORY Display memory contents.
- *MERGE Merge a program in memory with one on disc/cassette.
- *MOVE Move program to run at specified address.
- *NEW As NEW, but can be issued from within a program.
- *OFF Cancel enhanced error handling.
- *OLD As OLD, but can be issued from within a program.
- *ON Auto error handling - enters editor at line in error.
- *PACK Efficient program compactor.
- *RECOVER Intelligently recover bad programs.
- *RENUMBER Allow partial renumbering.
- *REPORT Extended error reporting facility.
- *SCREEN Screen dump to cassette or disc.
- *UTIL Display utilities menu.
- *UTIL 1 String search.
- *UTIL 2 String search and replace.
- *UTIL 3 Move Basic program lines.
- *UTIL 4 List procedures and functions.
- *UTIL 5 List values of A% to Z%.
- *UTIL 6 List numeric variables.
- *UTIL 7 List string variables.
- *UTIL 8 List names of arrays.
- *UTIL 9 Set up range for utilities 1 and 2.

BEEBUG SOFT

PRICE **£27.00** INC. VAT

Available from your local dealer and selected branches of W.H. SMITH'S

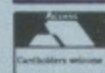

Access Orders and enquiries: Tel: ST. ALBANS (0727) 60263

Mail order (Post Free) to:

BEEBUGSOFT, Mailing Dept. 16 P.O. Box 109, High Wycombe, Bucks.

Half a box is better than one?

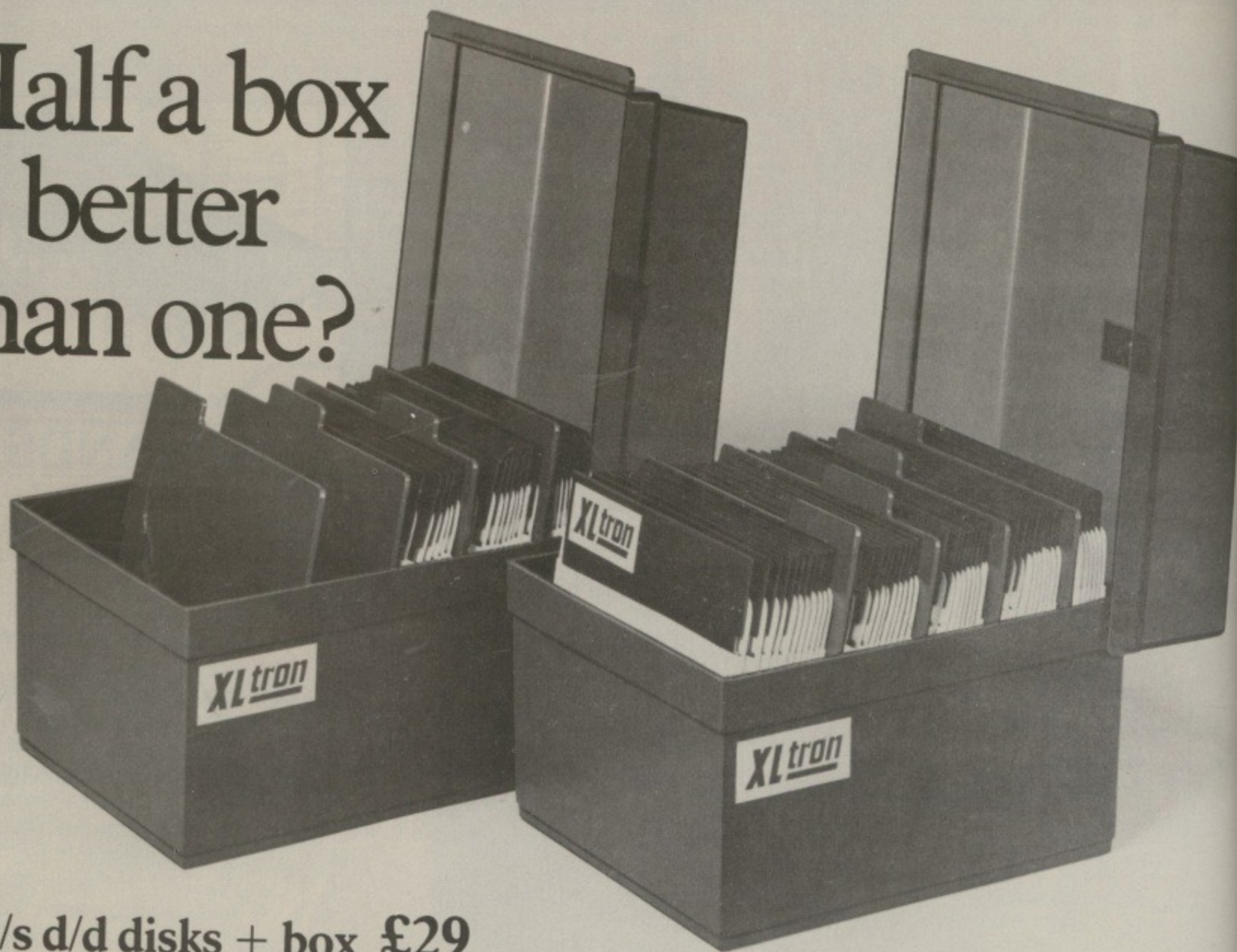

25 s/s d/d disks + box £29
plus VAT and P + P

25 d/s d/d disks + box £39
plus VAT and P + P

We ran the advertisement opposite to move some stock left from a cancelled order. And move them it certainly did. We're still selling around 30 boxes a day, that's over 30,000 disks a month. So we bought some more, and are going to continue selling at the same price.

We also got a lot of people on the phone asking if we could supply slightly fewer disks, and as you see, we're now offering boxes in 25's as well.

Every order of 25 or 50 comes packed in the same rigid plastic storage box with four dividers, we've kept the same high specification and all disks carry our two for one guarantee.

To order, just clip the coupon below. Personal callers welcome.

We accept orders from all government bodies, schools, universities, libraries, armed forces etc. We despatch on receipt of an official purchase order. If you can't raise a cheque without an invoice please post or telephone your order and we'll send you a proforma by return.

Disco Technology Limited, Lex House, 3/6 Alfred Place,
London WC1, England. Telephone 01-631 0255,

50 s/s d/d disks + box £50
plus VAT and P + P

50 d/s d/d disks + box £75
plus VAT and P + P

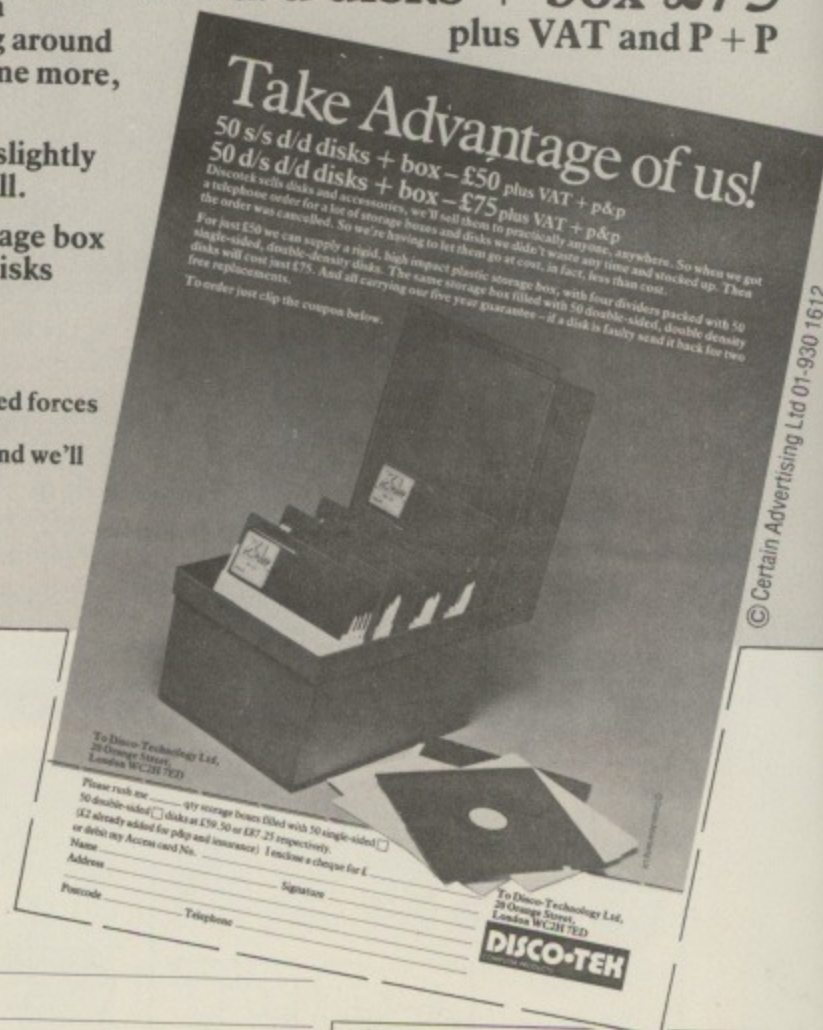

- Please rush me
- ___ (qty) storage box(es) filled with 50 s/sided disks at £59.50 each.
 - ___ (qty) storage box(es) filled with 50 d/sided disks at £87.25 each.
 - ___ (qty) storage box(es) filled with 25 s/sided disks at £33.65 each.
 - ___ (qty) storage box(es) filled with 25 d/sided disks at £47.15 each.
 - ___ (qty) empty storage box(es) at £11.

Prices include VAT and P + P. I enclose cheque for _____
or debit my Access card no. _____

Name _____ Signature _____

Address _____

Postcode _____ Telephone _____

To: Disco Technology Ltd, Lex House, 3/6 Alfred Place, London WC1.

MU/11

XLtron

A
on
qua
to t
tha
3" M
● Tw
lin
dr
● 20
40
● Ea
● Lo
● M
Dou
5 1/4"
DR
● Al
● Lo
co
● Co
● Di
540
540
580
5 1/4"
DR
● M
no
● Se
● U
540
540
580
FLC
3" c
5 1/4"
case

© Certain Advertising Ltd 01-930 1612

HIGH QUALITY DRIVES AT EVEN LOWER PRICES.

Opus disc drives are the best buys on the market.

We have reduced our prices, but the quality still remains as high as ever.

All our 5¼" drives have been tested to their limits, running for 8,000 hours – that's a year of constant use.

And when you look at our prices, you'll find that VAT, all necessary leads and carriage are included along with a two year guarantee – a year more than any other company can offer.

You can order by posting the coupon below or calling at our showroom.

3" MICRODRIVE.

- Twice the capacity on line of other available drives.
- 200K Single Density – 400K Double Density.
- Easy to connect to the BBC Micro. ● 3ms. Access time.
- Low power consumption – direct drive.
- Manual and free disc cartridge provided.

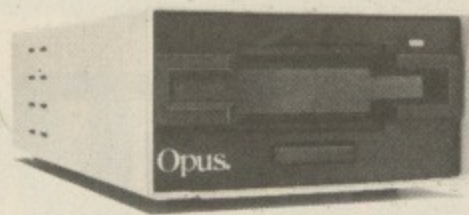

Double sided 40 Track Drive Single drive _____ **£199.95**
Dual drive _____ **£399.95**

5¼" SINGLE DISC DRIVES.

- All ½ height.
- Low power consumption.
- Comprehensive manual. ● Free utilities disc.
- Direct drive mechanism. ● Fast access time.

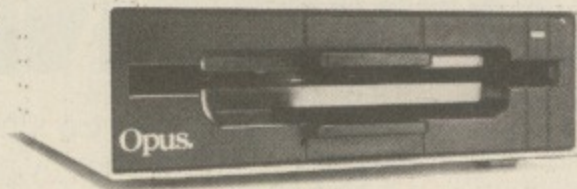

5401 100K Single sided 40 Track _____ **£149.95**
5402 200K Double sided 40 Track _____ **£169.95**
5802 400K Double sided hardware switchable
80/40 Track _____ **£199.95**

5¼" DUAL DISC DRIVES.

- Metal cased and all necessary leads.
- Separate power supply.
- Utilities disc and manual.

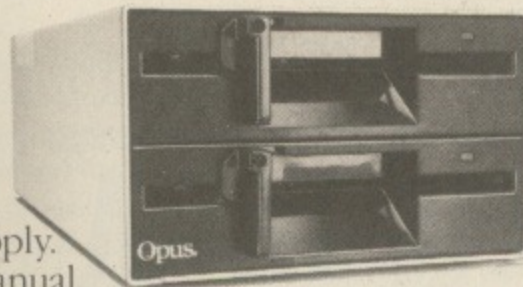

5401D 200K/400K on line S/sided 40 Track _____ **£349.95**
5402D 400K/800K on line D/sided 40 Track _____ **£399.95**
5802D 800K/1.6 Megabyte on line D/sided
hardware switchable 80/40 Track _____ **£499.95**

FLOPPY DISCS.

3" cartridge **£5.75** each or **£25.95** for 5.
5¼" Discs – with full 5 year warranty and free library case.
S/SS/D **£17.95** for 10.
S/SD/D **£19.95** for 10.
D/SD/D **£21.95** for 10.
S/S 80 Track **£25.95** for 10.
D/S 80 Track **£27.95** for 10.

DOUBLE DENSITY DISC INTERFACE.

The ultimate double density disc interface for your BBC Micro, compatible with 6502 2nd Processor.

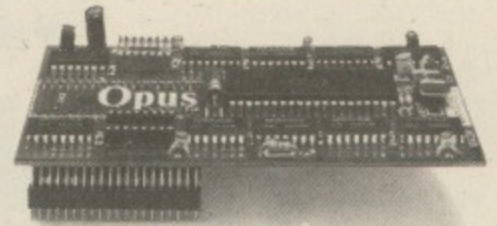

- Utilities on ROM including: Format and verify, tape to disc transfer, automatic 40/80 Track selection, automatic density selection, unique mass copy routine, powerful machine code operating system giving up to 248 files, 80% faster than single density. Easy to install. Free user manual supplied. _____ **£129.95**

GENEROUS EDUCATION AND DEALER DISCOUNTS GIVEN. ALL ITEMS ARE GUARANTEED FOR TWO YEARS AND ARE SUITABLE FOR USE WITH THE BBC MICRO.

OPUS SUPPLIES LTD.

158 Camberwell Road, London SE5 0EE.

Opening hours: 9.00-5.30 Monday-Friday, 9.00-1.00pm Saturday.



01-701 8668
01-703 6155

OPUS PRODUCTS ARE AVAILABLE FROM BOOTS, W.H. SMITHS, SPECTRUM, JOHN MENZIES, ALLDERS AND OTHER GOOD COMPUTER STORES NATIONWIDE.

To: Opus Supplies Ltd., 158 Camberwell Road, London SE5 0EE. Please rush me the following: **(ALL PRICES INCLUDE VAT & CARRIAGE.)**

Quantity	Description	Price

I enclose a cheque for £ _____ TOTAL.

Or please debit my credit card account with the amount of £ _____

My Access Barclaycard (please tick) No. is _____

Name _____

Address _____

Telephone _____

Opus.
Opus Supplies Ltd.

BU32



HIGH RESOLUTION THAT COMES HIGHLY RECOMMENDED

"There is no doubt that the JVC range of ECM colour monitors is excellent value for money . . . there is no loss in quality of picture after long periods . . . and remember, as more and more resolution is available with new micros, the need for a better display will be that much greater."

High recommendation indeed from Personal Computer News. Meanwhile Acorn User said:

"It seems that all 'normal' and 'medium' resolution monitors, including the Sanyo, are simply inadequate to deal with the Beeb's graphics and text output . . . The JVC was excellent, giving clear, legible results . . . Was the JVC better than the Microvitec?* Would I buy one? Yes to both questions."

Our RGB high resolution colour monitor (580 x 470 pixels) sells for £229.95 (excluding VAT) – that's a saving of over £100 compared with other leading monitors of similar specifications.

The unit has a 14" screen and is suitable for the BBC Micro, Electron, Sinclair QL, Lynx, Oric, Apple, IBM and most other leading micros.

MODEL REFERENCE	1302-2 High Resolution
RESOLUTION	580x470 Pixels
C.R.T.	14"
SUPPLY	220/240v. 50/60Hz.
E.H.T.	Minimum 19.5kv Maximum 22.5kv
VIDEO BAND WIDTH	10MHz.
DISPLAY	80 characters by 25 lines
SLOT PITCH	0.41mm
INPUT: VIDEO	R.G.B. Analogue/TTL Input
SYNC	Separate Sync on R.G.B. Positive or Negative
EXTERNAL CONTROLS	On/off switch and brightness control

And naturally there's a year's full guarantee.

If you order your monitor by post, you'll receive it within ten days by courier service.

Simply post the coupon below to: Opus Supplies Ltd, 158 Camberwell Road, London SE5 0EE. Or telephone 01-701 8668 quoting your credit card number. Or, of course, you can buy at our showroom between 9.00–5.30pm, Monday–Friday, 9.00–1.00pm, Saturday.

*Microvitec Cub 14" monitor

To: Opus Supplies Ltd., 158 Camberwell Road, London SE5 0EE.
Please send me:

_____ High Resolution Colour Monitor(s) at
£229.95 each (ex. VAT).

_____ Medium Resolution Colour Monitor(s) at
£179.95 each (ex. VAT).

_____ Connection lead(s) at £6.00 each.

I understand carriage per monitor will cost an extra £7.00. (N.B. A High Resolution Monitor including VAT, lead, and carriage costs £279.39. A Medium Resolution Monitor including VAT, lead and carriage costs £221.89).

I enclose a cheque for £_____ Or please debit my credit card account with the amount of £_____. My Access/Barclaycard (please tick) no. is _____

Please state the make of your computer _____

Name _____

Address _____

Telephone _____

Opus.
Opus Supplies Ltd.

**PIRATES FORCE
A&F OUT OF
BBC MARKET**

PIRACY of its products on a massive scale has forced leading software house A&F to abandon in-house development of games for the BBC Micro.

The firm's managing director, Mike Fitzgerald, described the decision as "regrettable in that the BBC is such a fine machine, bug unavoidable in view of the financial situation".

Fitzgerald told *The Micro User* he agonised for three months before deciding that Snarl-Up – companion to the best-selling Chuckie Egg and Cylon Attack – would be the last in-house game produced by A&F for the BBC Micro.

"It was a sad decision to take", Fitzgerald said, "but the pirates are so highly organised on such a massive commercial basis, we really had no choice."

Tightrope

"It costs us £35,000 to develop and market a new program and we need to sell 22,000 copies to break even. Wholesale piracy is cutting into sales to such an extent we're walking a financial tightrope."

"We just can't protect our BBC games completely enough against the powerful equipment pirates can buy over the counter these days and use to get into our tapes."

"I'm not talking about kids who get together to run off a few copies – that doesn't worry me particularly."

Hurting

"It's the big boys who are producing cassettes with up to 30 games on them who are really hurting us."

Fitzgerald warns that other software houses could follow A&F's lead.

A&F hasn't abandoned the BBC Micro completely. Fitzgerald will continue to publish other people's programs on the A&F label.

"But our future in-house development will concentrate on the Spectrum and Commodore, with projected heavy support for the MSX and Amstrad systems", he said.

**It's the
log-on
show**

THE big talking point in the computer world today is communications. And that's also the theme of the Electron and BBC Micro User Show at Alexandra Palace from October 25-28.

The availability of low cost, high quality communications packages – such as the one offered in this month's edition of *The Micro User* (see Page 210) brings this fascinating subject within the reach of every BBC Micro user.

Control

At the show Pace Electronics is showing how a schoolteacher can maintain control of a classroom full of pupils by means of its E-net networking system.

Micronet, the electronic magazine for the micro owner is also being demonstrated in depth.

And there will be demonstrations of how the exchange of data files between individual users avoids the tedium of hours of keyboard bashing.

Spanning

Communications is a truly international topic and the show is spanning the Atlantic to talk to computers in the US.

Knowledge Index is demonstrating how intelligent systems can answer a wide range of queries even at a distance of several thousand miles.

**Acorn expects
bumper Xmas**

WITH sales of the BBC Micro now edging towards the magical half million mark, Acorn is forecasting bumper Christmas sales for its dealers – and all the other firms making BBC Micro additions.

Chairman Hermann Hauser, presenting the company's annual report, said sales of the BBC Micro topped 220,000 in the last year – making a total of 370,000 since it was launched.

In the last year, too, 90,000 Electrons have been sold.

Said Hermann: "The company has grown spectacularly. In the last year we have become the largest British micro company by sales".

In the last year sales more than doubled, from £42.4 million to £93.2

million.

But such a go-go performance was not matched by profits, which limped up from £8.6 million to a miserable £10.8 million. The City showed its disappointment, with the share price dropping 11p to 107p – or 13p below last October's tender price.

Financial pundits had been forecasting profits of at least £15 million, so what had gone wrong?

Hermann Hauser admits that Acorn's attempt to crack the

£700 million market in the USA had proved "much more difficult than we anticipated".

However a rescue operation is now under way. But Acorn is cautious about making rash forecasts.

All Hermann Hauser is prepared to say is that the company expects "to reach profitability within the accepted timescale".

Back home, he sees Acorn's main growth to come from the sale of "various upgrade and expansion facilities" for the large number of BBC Micros and Electrons now in use.

And he hints that plans are under way to enter the telecommunications field.

MINI OFFICE BOOM

MINI Office, the revolutionary package from Database Publications that turns the BBC Micro into an inexpensive office tool, is selling as fast as it can be produced.

The professionally written word processor, database, spreadsheet and graphics package costs only £5.95 on tape and £7.95 on disc.

"We're working flat

out to keep up with the demand", says Database joint managing director Derek Meakin.

Crazy

"At the PCW Show we had people from other software houses coming up to us saying we were crazy to sell it at such a low price. Many said it ought to be at least £15."

"But it was a

deliberate decision to keep the price down and go for volume sales – and events have proved us right.

"The only snag is that some people feel that for £5.95 they cannot be serious programs. So we had a printer on our stand churning out business letters and graphs – and that soon convinced them!"

Young masters make their move

PRIMARY schoolchildren throughout the UK are competing in "Make Your Move", the first-ever computerised chess championship.

It is being sponsored by Acorn and the BBC's teletext service, Ceefax.

In the final stages contestants will compete from their own schools using BBC Micros with chess software and linked by phone line to the Ceefax computer in London.

Contestants' moves will be displayed on Ceefax pages, allowing the games to be viewed by chess enthusiasts throughout the country.

A knockout five round British Chess Federation random Swiss system tournament will produce eight regional winners for the national finals in January.

First prize for the winner's school is a BBC Micro with monitor, cassette recorder and teletext adapter.

The runner-up will receive a BBC Micro for the school and the remaining six finalists will get a teletext adapter or cash equivalent.

All finalists will receive an engraved chess clock.

Designing micro

A NEW computer aided design system for the BBC Micro has been announced by Ibbotsons Design Software.

It is claimed to provide easy generation of circles, arcs, ellipses, hatching, repetition and the ability to build libraries of elements.

Drawings are created on screen with single keystroke commands, stored on disc and printed on a dot matrix printer.

Also available is a 3-D generator for making perspective views.



Playing chess on a BBC Micro is eight-year-old Simon Huth from Brighton - watched by international chess master William Hartston

BAR CODE READER FOR SCHOOLS

MEP, the micros in schools project, has designed an educational bar code reader pack for the BBC Micro. It is being distributed by educational publisher Addison Wesley.

They say it will suit information technology students of all levels from primary school onwards.

The aim is to show students how bar codes act as a quick, foolproof way to input data, key words - even music - and to give an introduction to character recognition.

Starting with such

exercises as reading the codes on packaged goods from the local supermarket, the student is introduced to an eight bar code where thick and thin lines represent the binary digits 0 and 1, giving a range of 255 Ascii characters.

Also dealt with is Telepen code, which uses different thicknesses of lines and spaces to condense program listings to a fraction of their usual length. Software is also included which will produce bar codes on most printers. This even

applies to daisywheels, where the lower case *i* is repeated to form the bars.

The bar code reader can also be used as a simple digitiser, enabling scanned pictures to be reproduced on screen.

The pack comprises a reader with software on disc or cassette, a teachers' guide, plus a stencil for drawing bar codes by hand.

Available soon will be applications programs for library administration, multiple-choice exam marking and stock control.

Woodn't you just believe it...

THIS is a story about a company lumbered with a boring boring problem that a BBC Micro whittled down to size.

Rackmaster of Salisbury makes wooden plate racks for stores like Harrods where the upper branches of society do their shopping.

So quality has to be top notch or the fir begins to fly in the workshop.

The knotty problem was finding people who

could operate a drill precisely hour after boring hour without it going against the grain.

With over 200 cavities in the larger racks, workers were finding the whole thing extremely repetitive and tiresome and accuracy tended to suffer.

Enter the Small Firms Service of the Department of Trade and Industry. With their help, the firm's owner, Mike Holder, designed and built a machine that

drills all the holes automatically.

Pieces of wood are simply loaded into a hopper and the drilling is activated from the BBC Micro keyboard.

The program copes easily with different lengths of wood that need different numbers of holes.

"We built the system round the BBC Micro because it was one of the most flexible low priced computers suitable for the job", says Holder.

British Telecom launches Firebird

BRITISH Telecom has entered the software market with 20 new games - four of them for the BBC Micro - under the Firebird label.

Despite being priced at only £2.50 each, the games are said by BT to be "the same quality as some products costing twice as much".

The first releases are all games, but educational software and other types of programs will be produced at a later date as will a series of "premium-range programs", according to a company spokesman.

Music package

NEW software house Island Logic has released its first product - a complete music package for the BBC Micro.

Music System is a co-development with System, the software firm that produced Music Editor for the BBC Micro last year.

First of a projected range aimed at the growing disc market, the system incorporates five distinct elements - editor, keyboard, linker, printer and synthesiser.

A recent order for Macy's department store in New York involved drilling 27,000 holes in a few days.

"It would have been a daunting task to do by hand, but now it is just a minor part of the hole job", quipped Holder.

The system has been so successful that Holder is developing the idea for use by other firms with repetitive work.

Success on a plate, as they say at Rackmaster.

BBC MICRO JOINS IN OPERATION RALEIGH

THE intrepid BBC Micro is set to venture where no computer has been before — the exotic locations of three projects planned for the Operation Raleigh round-the-world expedition.

The machines will be helping young explorers study Costa Rica's rain forest, survey flooded caves in the Bahamas and

analyse crocodile populations in Honduras.

A satellite-linked computing laboratory donated by Acorn Computers will be on board the Sir Walter Raleigh expedition flagship when it leaves the UK on November 13.

The lab is equipped with 11 BBC Micro systems, of which seven will be used in the field while the others will play a key role in ship administration and in the analysis of research data

from projects carried out on board ship and in the field.

Computers on the ship will be linked by satellite to micros at Leeds University.

Teams in London, Hull and Leeds will be using other BBC machines to coordinate planning and help organise research groups in the field.

Operation Raleigh, the biggest multi-national expedition ever undertaken, aims to present youngsters from all walks of life with challenges and hardships designed to pay off in terms of character-building and scientific discovery.

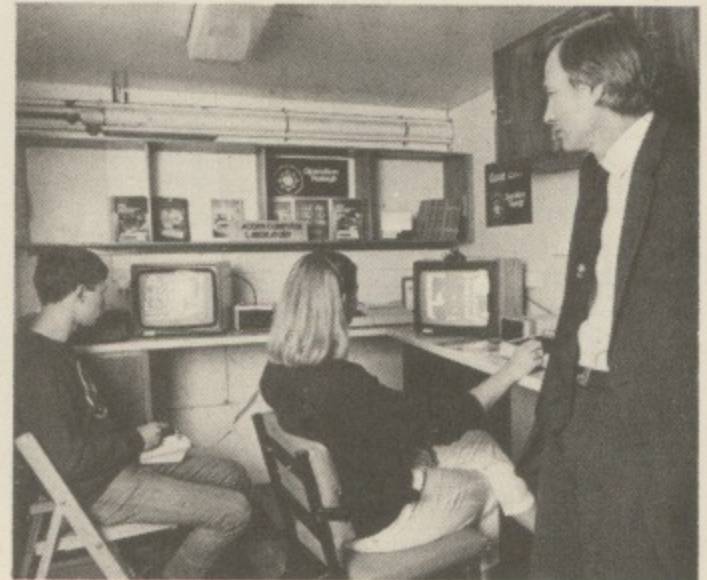

Dr Stephen Sutton (right), director of research for Operation Raleigh, in the Acorn computing laboratory on board the Sir Walter Raleigh.

More business software packs

ONE of Britain's leading business software houses has shown its faith in the future of the BBC Micro as a machine suitable for use in small businesses.

Systematics International has launched two programmes initially.

Sales and Purchase Ledger Duo controls cashflow by providing a record of incoming and outgoing, keeping accounts up-to-date and issuing statements and reports. It automatically produces VAT statistics for returns and year end accounts for auditing.

Stock Control and Invoicing Duo monitors and automatically adjusts stock levels, while issuing purchasing recommendations.

The duos cost £89 each.

Systematics International marketing manager Brian Reynolds said: "We started writing business software for the most popular micros in 1980. First Apple, then the ACT range and IBM.

"But the obvious popularity of the BBC Micro with the general public in the UK has now made us decide to provide software for this machine as well — to enable even the small businessman to obtain the benefits of business computing".

Micro guide for disabled

A NEW edition of a guide to computers for the disabled has been published by Sunderland Polytechnic.

It includes details of products that enable disabled persons to use computers in cases where their disability prevents them using standard equipment.

Also included in the guide, price £8, are addresses from which details of educational software for the handicapped may be obtained.

The 240-page guide, first published in 1980, draws on sources in the UK, Europe and North America and describes special equipment for the blind and visually

impaired, the speech and motor impaired, the physically handicapped, the mentally handicapped, and the hearing impaired.

It also contains a glossary of medical and computer terms, and addresses of computer-oriented educational and other specialist organisations.

Shop assistant is a micro...

THE BBC Micro is central to a new product designed to help shopkeepers to sell outside their normal trading hours.

The micro sits in the shop window 24 hours a day. Passers-by can ask it questions about the merchandise and see the answers on the screen.

They can also place orders when the shop is closed.

Operation is by a "touch-pad" stuck to the inside of the shop window and connected to the computer through a single lead.

Behind the idea is former school teacher and programmer Ron Binstead, 40, who has been

inventing electronic gadgets since he was at school.

With his brother, who is doing a robotics doctorate at Brunel University, Binstead hopes to market the product in Britain and the US.

He says it is ideal for any business where the customer needs more details about what is on offer — estate agents, employment agencies and insurance brokers.

An estate agent could use a menu asking the customer to enter details of his required price range, location, number of bedrooms. The micro would then reply with a list of suitable houses.



After-hours shopping by a finger on the window

Indonesia picks BBC

THE Indonesian Ministry of Education is on a buying spree in the UK. Included on its shopping list are BBC Micros, Cumana disc drives and Microvitec colour monitors.

Turtle on the air

A GRAPHICS turtle, invented at MIT and further developed at Edinburgh University, is now available in a radio-controlled version for the BBC Micro.

John Jessop, who builds the turtle at his London factory, has just perfected the radio model. He says the older, tethered turtles will convert from umbilical cord to remote control.

Fans of radio control claim that rival turtles controlled by infra-red beams don't perform so well.

But manufacturers of infra-red turtles claim the radio controlled ones suffer from interference from passing mini cabs.

A full LOGO for the BBC model "B" from Logotron.

LOGO is a computer programming language, which appeals equally to children in primary school or to computer scientists at the Massachusetts Institute of Technology. Using LOGO, you unconsciously absorb advanced mathematical ideas and fundamental principles of computer programming. LOGO has been available on microcomputers only since 1982. Only this year has it been made available on British home computers like the Sinclair Spectrum and the BBC Micro.

LEONARDO WOULD HAVE LOVED IT!

Leonardo da Vinci would have loved it because LOGO gives full rein to a child's creative imagination, using visual images to convey profound ideas. LOGO could do for computers what perspective did for pictures, bring them alive.

Logotron's LOGO for the BBC "B" was written by LCSJ/SOLI, the software house responsible for LOGO implementations for Atari, Apple, IBM, Sinclair, Coleco, and NEC. It's the closest there is to an international LOGO standard, with turtle graphics and full list processing. The software is contained on a single 16k ROM, written in 6502 machine code, fully compatible with the 6502 second processor unit and Econet. Facilities are provided to drive floor turtles, create and use data files, and access routines written in machine language. Full access is provided to the BBC micro's operating system. An optional sprite board, also provided by Logotron, can be used to handle video output and provides more than 30 programmable sprites, allowing true animation.

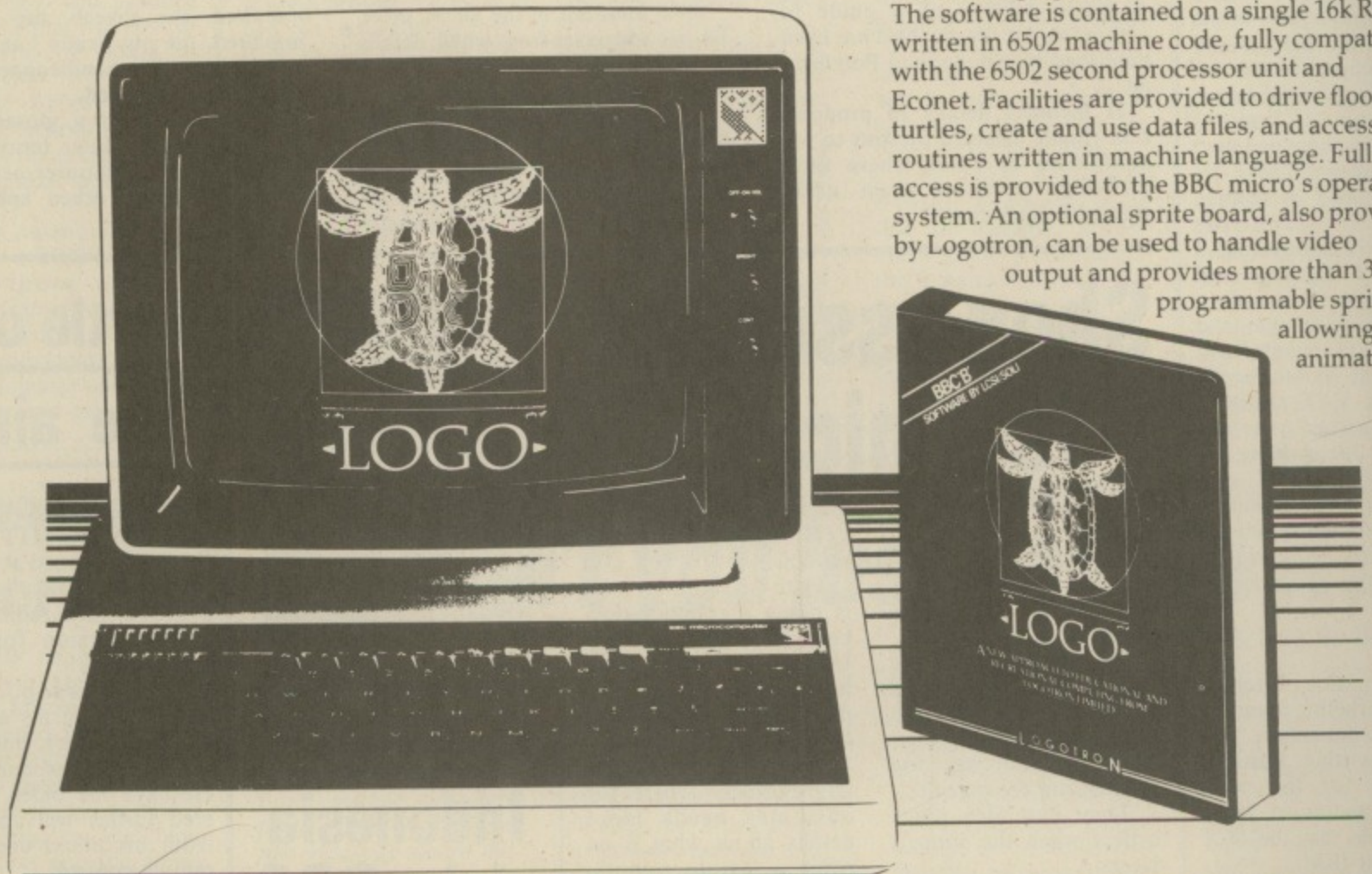

Please send me further information concerning Logotron's LOGO for the BBC Model "B".

NAME

ADDRESS

..... Educational Establishment;

Home user; Dealer*; Distributor* *attach to company letterhead

If you want to know more about LOGO, send for a descriptive leaflet and price list.

To: Logotron, Dept. MU3, 5 Granby Street, Loughborough, Leicestershire LE11 3DU, England.

LOGOTRON

Micros move into the kitchen

LIKE many other software houses, Shumwari Associates are concerned about the lack of female enthusiasm for computers.

Their aim, they say, is to take women out of the kitchen and place them in front of keyboards.

So they have produced a sophisticated program for female BBC Micro users that will entice them . . . right back into the kitchen.

Comp-u-Cater is a disc based menu planner and recipe file.

It can plan a menu from the recipe file, provide printouts for the table, the kitchen and the shops, and allows the user to amend and create recipes.

There are 228 recipe cells in the program divided into five categories – starters, main dishes, vegetables, accompaniments such as salads and desserts.

These subdivide by means of menu choice option screens until the desired recipe is reached.

After receiving the printout, all the user has to do is buy the ingredients and cook them.

Shumwari hasn't yet come up with a program that will perform these tasks.

Maths aid

HELPING children get a grasp of maths, literacy and logic are three educational programs for the BBC Micro developed by Applied Systems Knowledge.

Like all ASK programs, the new titles "Podd", "Squeeze" and "Juggle Puzzle" have been written by practising teachers working with professional programmers, and are designed to make learning fun.

They cost £9.95 or £11.50 on disc.



Richard, 8, sets family on road to fame

WHEN the Hollis family of Frome, Somerset, bought their BBC Micro last year they encountered a slight problem.

While his parents and older brother enjoyed their new world of adventure games, eight-year-old Richard Hollis found it all a bit of a turn-off.

He was desperately keen to play, but found the text-dominated programs difficult to follow.

So his mother, Kristin, and brother Martin, aged 12, decided to write a game Richard could cope with on his own.

That first attempt at program writing led to further bursts of creative activity from the Hollis

household, and eventually to publication in leading computer magazines including *The Micro User*.

Now the mother-and-son team has come up with an adventure game for five to nine-year-olds that is being marketed on cassette by Database Publications.

Called *The Magic Sword*, it allows youngsters to explore a fairy tale world peopled by familiar story book characters and sprinkled

with magic.

Its colourful animated graphics and exciting sound effects encourage the player to travel through the countryside, explore a castle with secret passages and dungeons and rescue a beautiful princess from the clutches of a witch.

A special bonus for buyers of the £8.95 cassette is a free 48 page full colour book that recounts all the events leading up to the start of the adventure.

Kristin Hollis wrote the

book with help from Martin, who drew the illustrations. Martin devised the game program based on his mother's design and graphics.

Now the pair are hoping to have more games published on cassette.

Kristin Hollis said: "Now we are hoping for further success. We have written a nurseryland game for children aged four to seven and are working on one based on a traditional fairy story which will appeal to the seven to nine age group".

● *In our picture authors Kristin and Martin Hollis watch Richard test The Magic Sword.*

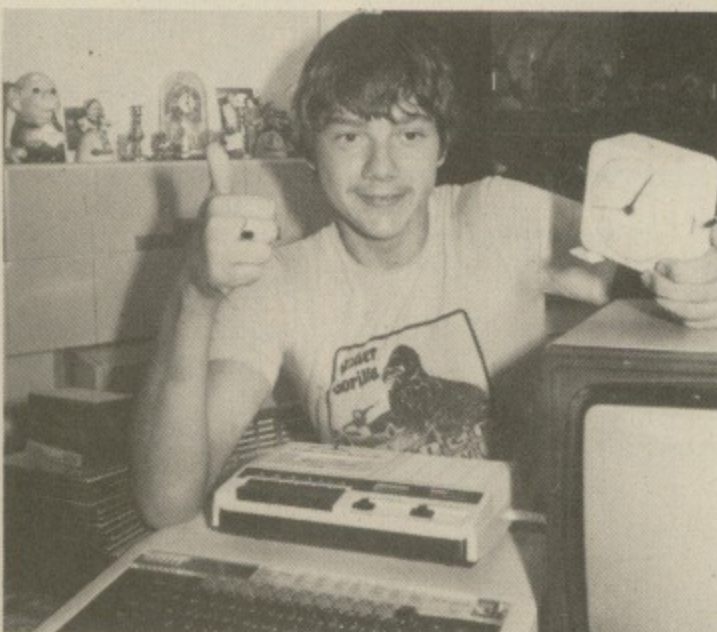

Zapped out!

YORK schoolboy Owen Coates, 14, is claiming a world record for playing video games after a non-stop alien zapping stint in Leeds. "I kept nodding off a bit, but my fingers were still going on the buttons", the youngster said after clocking up 51 hours 21 minutes at the controls of his BBC Micro.

Owen was attempting to beat the previous record of 23 hours 10 minutes when he heard that another challenger playing at the same time in Bridlington had reached 50 hours.

So the plucky youngster gritted his teeth, flexed his fingers and – with support from sister Michaela who kept dousing him with cold water – zapped on for another 28 hours.

When it was all over, Owen slept for 12 hours then enjoyed his reward – a meal paid for by Michaela.



BBC gets a touch screen

A TOUCH screen display which interfaces with the Thorn EMI VHD videodisc player and the BBC Micro has been introduced by Cameron Communications.

Interact B allows the user to control the disc player by touching the screen. Colour text

and graphics from the BBC Micro are superimposed on the video image to generate touch menus.

Interact B will be available this year for system developers and pilot videodisc projects. Volume shipments are planned for January.

Family snaps can go on disc

INSTEAD of pasting treasured photographs in the family album, why not store them on disc or cassette?

BBC Micro owners can now do this, after a fashion, with the help of a video digitiser from R.H. Electronics.

At £250 it isn't the cheapest way of preserving snapshots. Nor is the resolution as good as you might prefer.

But RHE project coordinator Graham Tibbet sees the new machine being of great use to graphic artists and software program writers.

Applications

Other applications are emerging in the fields of engineering and medicine.

Kings College Hospital, London, is using a video digitiser with a spectrum analyser for measuring blood flow in pregnant women.

And a North of England engineering company is using the equipment to calibrate fuel gauges at a reported saving of £35,000.

Tibbet says a machine with image analysis capabilities is "only a few weeks away". This will further increase the value of the digitise to science and industry.

ACORN MAKES IT EASY AS ABC

ACORN researchers say they have identified four slots in the computer market which they intend to fill with the recently unveiled ABC range of business micros.

All are based on the BBC Micro, with a choice of second processor additions. There are eight models in the range.

The basic 32k machine features Econet, plus instant word processing and spreadsheet from two programs in permanent memory. It has one 640k

floppy disc and 12in black and white screen.

Next model up the range has an extra floppy disc and a Z80 second processor running CP/M. An enhanced version has a 10mbyte Winchester replacing one of the floppies, plus a colour monitor.

Two "academic"

models are aimed at universities, R & D departments and the like. They have 16/32 bit processors and 256k RAM as standard.

As before, there is a choice of a Winchester-equipped version with colour monitor, and this model will run the Unix operating system. Lan-

guages offered include C and Pascal.

Finally the top-of-the-range Executive workstations offer IBM compatibility and multi-tasking.

An Intel 80286 chip runs Digital Research's Concurrent operating system and supports applications written for PC/DOS, MS/DOS and CP/M 86.

The 256k RAM can be upgraded to 1mbyte. As before, there are two versions, one with twin floppies and b/w screen and the other with one floppy replaced by a 10mbyte Winchester and colour screen.

Next year Acorn plans to bring out a mouse for the two executive models.

New medical role for micro

NEW roles for the BBC Micro in medical and industrial research and analysis are opened up by the new Video Interface Peripheral from Sight Systems.

Priced under £3,000 the VIP is a tool for universities and research establishments contemplating using BBC Micros in an image analysis or

image processing application.

The machine stores grey and binary images for further processing and analysis by the computer. By selecting upper and lower threshold (grey)

levels, the grey store is segmented and the accepted regions are converted to peak white and written into a binary store.

By providing a separate video rate binary image store, the user can isolate features of interest for analysis, counting and area type measurements.

Switch

The frame store images can be displayed on the monitor at full resolution (2 to 8 bits) and only one monitor is required as the VIP can switch between computer text and video from the output DAC, which displays contents of the binary and grey level stores.

Graphs on tap

MICRO users taking O and A levels can now study the graph and equation side of mathematics with a package called Graph-Easy.

According to its Norwich-based publisher, Hama Systems, the package can also be used to

solve high-level engineering, scientific and business problems.

It comes on disc or cassette complete with a manual containing exercises and assessment questions for students at all levels from newcomers to post-graduates.

MAKE A MILLION

INCENTIVE Software has released Millionaire, a simulation of running a software company. Versions are available for the BBC and Electron on one double sided cassette.

It includes graphics of your house, which increases in size as your profits grow.

Players start with £500 to market a program. By careful marketing and maybe the odd dodgy deal with Honest Harry you can move from humble beginnings to a millionaire's estate.

But beware - such a deal could put you on the wrong side of the law!

QUALITY NEVER LOOKED SO GOOD—

Now everyone with a BBC or IBM PC will want to get their paws on CUB's sleek new D series plastic cabinet — a triumph of ergonomics and up to the minute design. Within it is the CUB 653 MEDIUM RESOLUTION colour monitor — the perfect mate for computer users who wish to combine the advantages of brilliant, low cost colour graphics with 80 column processing software.

CUB 653's remarkable depth of colour is enhanced by minimal screen glare, thanks to a super high contrast CRT. Even in well lit environments the 653 (H) x 585 (V) resolution and 0.43mm dot pitch produces 80 column text which is pin-sharp and easy to read. Owners of SHARP, RML 480Z, APPLE Series, WANG and other leading computers needn't feel left out, because CUB 653's compatibility extends to these models and many more.



PICK ONE UP FOR JUST £299 inc. VAT

NEW LOW PRICE, NEW PLASTIC CABINET — THERE'S NEVER BEEN A BETTER TIME TO BUY.

Standard Resolution version also available in new cabinet. Both Standard and Medium resolution models produced in metal cabinets if required.

MICROVITEC 653
CUB
COLOUR DISPLAYS

Microvitec PLC, Futures Way, Bolling Road, Bradford, BD4 7TU, West Yorkshire.
Tel: (0274) 390011 Telex: 517717



Available from High Street Computer Retailers and selected branches of W. H. Smith, Harrods, John Lewis Partnership, John Menzies with selected models available from larger branches of Boots.

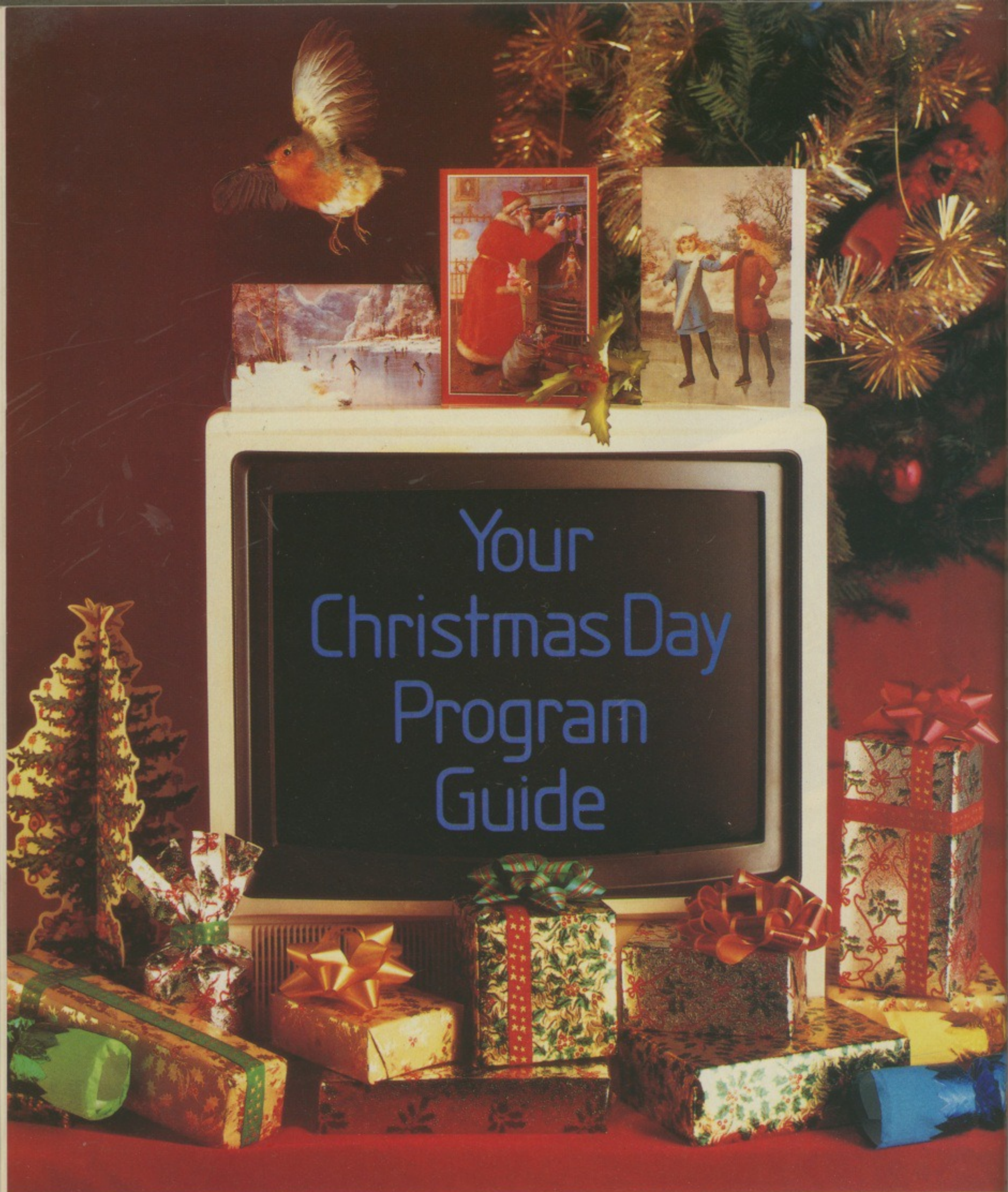

Your
Christmas Day
Program
Guide

Acornsoft announce tidings of great joy for both BBC Micro and Electron owners: eight brand new programs for Christmas.

Each one makes an ideal stocking filler.

They're all available at your local Acorn stockist. (To find out where that is, simply call 01-200 0200.) Or you can send off for our

catalogue and order through the post by writing to Acornsoft, c/o Vector Marketing, Denington Estate, Wellingborough, Northants NN8 2RL. Tel: 0933 79300.

Alternatively, however, you could always take a chance and drop a line to Father Christmas.

ACORNSOFT
Software for the BBC Micro and Electron

9.0
A f
dru
run
des
10
A g
ing
con
col
12
A s
a sp
in y
to p
1.0
A c
rec
roll
wil
3.0
'Go
mo
stro
deg
4.0
At
bec
hel
incl
you
5.0
Wit
suff
6.0
Stu
ten
bou

9.00 Firebug

A fast moving arcade-type game in which you are a fireman, trying to rescue some oil drums and take them to the safety of a water tank. Your opponent is the firebug who runs around lighting fires which move slowly towards the drums and fire extinguishers, destroying them if contact is made.

10.00 Maze

A gripping graphics game where you enter a top secret installation with the aim of stealing secrets from a rival company. The security system, however, has many levels each consisting of a maze of corridors patrolled by armed robot guards. Complete with full colour 3-D graphics, sound effects and a high score table.

12.00 Elite

A superb 3-dimensional graphics game that's light years ahead of any other. You are a space trader who roams the universe, making your living from buying and selling cargo in your Cobra space craft. On your travels, you will encounter aggressors who are eager to put an end to your dealings. Be warned, only the fittest will survive.

1.00 Crazy Tracer

A crazy adventure in which you guide a paint roller round the edge of a maze of rectangles, while avoiding the monsters which are trying to stop you by crushing the roller. Beware – as the game progresses, so the number of monsters chasing you will increase.

3.00 Go

'Go' is a board game for two players which originated in China 3000 years ago and is now more popular than Chess in the Far East. It requires strategic insight, intuition and a strong, calculating mind. If you wish, you can also challenge the computer at differing degrees of difficulty. A velly good game indeed.

4.00 Watch Your Weight

At last, a weight-loss program designed especially for you. With it, your computer becomes an expert wholly conversant with and sympathetic to your needs, and will help you choose an appropriate and individual weight-loss plan. The program also includes a calorie counter and a series of apposite menu suggestions to help stimulate your imagination when you just can't think what to eat.

5.00 The Complete Cocktail Maker

With everything from a Black Russian to a Betsy Ross, this program contains data sufficient to concoct a staggering 320 different cocktails.

6.00 Paul Daniels' Magic Show

Stun and amaze your friends with your astounding feats of magic. This program contains ten tricks to be performed by or with your BBC Micro/Electron. Hurry though – it's bound to disappear fast.



MD 400
£155.65
+ VAT = £179

MD 800
£312.17
+ VAT = £359

MD 800P
£373.04
+ VAT = £4

BBC Compatible Mitsubishi Slimline Disc Drives

These are high capacity, precision drives with dynamic clamping and very low power consumption. All drives are supplied with cables, a very comprehensive utility/format disc and a manual.

- MD 400 – 400K (800K double density) 40/80 track switchable double sided single drive.
- MD 800 – 800K (1600K double density) independently 40/80 track switchable double sided dual drive.
- MD 800P – 800K (1600K double density) independently 40/80 track switchable double sided dual drive unit with built-in power supply and monitor stand.

Opening Hours: Mon-Fri 9am-6.30pm
Sat 10am-5pm (ample parking)
We accept telephone orders on Barclay
and Access Cards.

Mail Order: Cheques or bankers draft
payable to Akhter Instruments.
Delivery free of charge (UK only)



COMPUTER GROUP

28/29 BURNT MILL, HARLOW, ESSEX CM20 2HU UK.
TEL. HARLOW (0279) 443521 TELEX 818894 AKHTER G

Dealer Enquiries
Welcome

AT last we've reached the stage where we can work on writing real programs. Have a look at Program I, it's fairly simple:

```
10 REM PROGRAM I
20 MODE 6
30 FOR loop% = 1 TO 10
40 PRINT RND(10)
50 NEXT loop%
```

Once you've got it typed in, run it through a couple of times and take careful note of the result.

Unless you're the kind of person who can continuously roll sixes with successive dice, the results should show significant differences.

This is because RND – which stands for random – generates a random number.

If you like, the micro electronically tosses a die – only you can pick how many faces the die has.

If you choose, say RND(5), the micro will throw a five-sided die and pick a number between one and five.

RND(10) on the other hand, will throw a 10 sided die, returning a number between 1 and 10. Notice we're talking about whole numbers – that is, integers. No fractions allowed.

We use the function RND where we want to bring an element of chance into computing or, as one cynic remarked, to make it more human.

Let's use RND's powers to create a decision taker. Look at Program II.

The idea is for the micro to choose randomly between five different decisions.

To do this we read the randomly chosen number between one and five,

```
10 REM PROGRAM II
20 MODE 6
30 DIM decision$(5)
40 FOR loop%= 1 TO 5
50 READ decision$(loop%)
60 NEXT loop%
70 REPEAT
80 CLS
90 PRINT TAB(2,12) "Press Space to
make your decision."
100 REPEAT
110 dummy$=GET$
120 UNTIL dummy$=CHR$(32)
130 PRINT TAB(2,14)
```

DECISIONS, DECISIONS, ALL THE RND DECISIONS

then use this number to index a string array containing the decisions.

Let's look at this in detail:

Lines 30 to 60 dimension the array *decision\$()* and then read into it the decisions from the five data statements in lines 190 to 230.

Thus, *decision\$(1)* would be: "Don't do it", *decision\$(2)* would be "Oh, what the hell?" and so on.

The lines 70 to 170 contain the bulk of the program – a large REPEAT... UNTIL loop allowing you to obtain multiple decisions from the micro.

Lines 80 and 90 clear the screen and urge you to press the space bar to make the decision.

Lines 100 to 120 hold the program up until the space bar – CHR\$(32) – is pressed.

Line 130 does the hard work by

```
decision$(RND(5))
140 PRINT TAB(2,16) "Press Space to
continue."
150 REPEAT
160 dummy$=GET$
170 UNTIL dummy$=CHR$(32)
180 UNTIL FALSE
190 DATA "Don't do it."
200 DATA "Oh, what the hell?"
210 DATA "It's a very good idea."
220 DATA "You'll be sorry if you
don't."
230 DATA "You'll regret it if you
do."
```

randomly choosing *decision\$()*.

When the micro encounters the RND(5) inside the brackets of *decision\$()* it randomly picks a number between 1 and 5 and uses this as the subscript of *decision\$()*.

The micro then prints out the selected *decision\$()* at the correct TAB.

So although you know line 130 is going to print out one of the array *decision\$()*, you don't know exactly which one.

If having that RND(5) inside the brackets is causing you a bit of bother, look at it this way. We can split line 130 over two lines by introducing *random%* a variable to hold our random number as follows:

```
130 random% = RND(5)
135 PRINT TAB(2,14) decision$(random%)
```

All we did in the original line 30 was to use RND(5) directly in place of *random%* – the micro doesn't mind at all.

Moving onto lines 140 to 170 the micro prompts for the space bar to continue, and uses the same loop as before to wait for it.

As soon as the space bar is pressed the micro encounters the UNTIL FALSE of line 180 and begins the main loop all over again. Easy, isn't it?

Notice, however, the give-away "same loop as before". If it is identical,

From Page 35

why not put it in a procedure, called PROCwait_for_space?

If you look at Program III you'll see that's what I've done:

```

10 REM PROGRAM III
20 MODE 6
30 DIM decision$(5)
40 FOR loop%= 1 TO 5
50 READ decision$(loop%)
60 NEXT loop%
70 REPEAT
80 CLS
90 PRINT TAB(2,12) "Press Space to
make your decision."
100 PROCwait_for_space
110 PRINT TAB(2,14)
decision$(RND(5))
120 PRINT TAB(2,16) "Press Space to
continue."
130 PROCwait_for_space
140 UNTIL FALSE
150 REM =====
160 DEF PROCwait_for_space
170 REPEAT
180 dummy$=GET$
190 UNTIL dummy$=CHR$(32)
200 ENDPROC
210 REM =====
220 DATA "Don't do it."
230 DATA "Oh, what the hell?"
240 DATA "It's a very good idea."
250 DATA "You'll be sorry if you
don't."
260 DATA "You'll regret it if you
do."

```

However, there's more we can do to make it more "procedural".

Initially we had to dimension decision\$() and read the values in.

That's quite essential, but we could really do with hiding all that clutter away in a PROCinitialise. This will allow us to see far more easily what the main program is getting at - what programmers call its structure.

I've done this in Program IV. Have a look at it and I think you'll agree that it's far easier to read and make sense of than the original Program II.

So using procedures sensibly - we term it structuring - makes programs far easier to follow. And if they're easier to follow they're easier to debug - that is, sort out mistakes, later.

Mind you, we've gone about this in a back to front manner. We've written the

```

10 REM PROGRAM IV
20 MODE 6
30 PROCinitialise
40 REPEAT
50 CLS
60 PRINT TAB(2,12) "Press Space to
make your decision."
70 PROCwait_for_space
80 PRINT TAB(2,14)
decision$(RND(5))
90 PRINT TAB(2,16) "Press Space to
continue."
100 PROCwait_for_space
110 UNTIL FALSE
120 REM =====
130 DEF PROCinitialise
140 DIM decision$(5)
150 FOR loop%= 1 TO 5
160 READ decision$(loop%)
170 NEXT loop%
180 VDU 23;8202;0;0;0;
190 ENDPROC
200 REM =====
210 DEF PROCwait_for_space
220 REPEAT
230 dummy$=GET$
240 UNTIL dummy$=CHR$(32)
250 ENDPROC
260 REM =====
270 DATA "Don't do it."
280 DATA "Oh, what the hell?"
290 DATA "It's a very good idea."
300 DATA "You'll be sorry if you
don't."
310 DATA "You'll regret it if you
do."

```

program and then turned it into one with procedures.

It's much better to consider a program as consisting of separate building blocks or modules. If we plan our program in these terms we can then easily code these separate modules into procedures.

As an example, let's look at a program that throws a dice for us. It'll need three parts:

- You tell it to throw.
- It chooses the number thrown.
- It prints out the number.

Notice the three stages correspond to *input*, where it gets the word to throw from you, *processing*, where it does its computing, and *output*, where it tells you the results. Much of computing obeys this simple model.

Look at Program V. This contains the bare bones of the program. PROCinput, PROCchoose_die and

```

10 REM PROGRAM V
20 MODE 6
30 REPEAT
40 PROCinput
50 PROCchoose_die
60 PROCprint_out
70 UNTIL FALSE

```

PROCprint_out. And all three are in a REPEAT... UNTIL FALSE loop. It couldn't be simpler.

Don't try to run it, though - I haven't defined any procedures yet!

You could actually put dummy procedures in by adding the following:

```

80 END
100 DEF PROCinput
199 ENDPROC
200 DEF PROCchoose_die
299 ENDPROC
300 DEF PROCprint_out
399 ENDPROC

```

You could then fill in the code line by line for each of the procedures separately and still be able to RUN the program to make sure each stage is working properly.

Program VI shows the finished product:

```

10 REM PROGRAM VI
20 MODE 6
30 REPEAT
40 PROCinput
50 PROCchoose_die
60 PROCprint_out
70 UNTIL FALSE
80 REM =====
90 DEF PROCinput
100 PRINT "Press space bar to
throw"
110 REPEAT
120 dummy$=GET$
130 UNTIL dummy$=CHR$(32)
140 ENDPROC
150 REM =====
160 DEF PROCchoose_die
170 die%=RND(6)
180 ENDPROC
190 REM =====
200 DEF PROCprint_out
210 PRINT "You threw ";die%
220 ENDPROC

```

PROCinput is virtually identical to

So
adve
ever
Exp
only

AV
"This is
you buy
DE
(Crash)
FA
succeed
won't w
FA
sophistic
adventu
(Crash)

FR
masterfu
should di
(Aardva
TH

you hook
but still ve
SO
a spy. He's
guards: wa
card. STIX
SAV
- we use the
Home Comp
socket or an
anyone inte
SAVE £5.8
present than
DISK DOCT
have this ch
most useful

SO
To: SO
87 HOW
(If you d
and quo
I have a
I enclose
OR CHA
No:
Signature
Please wr
Name
Address
Phone, if

From Page 36

PROC_wait_for_space in Program IV. It just tells you to press the space bar when you want to throw.

PROCchoose_die picks a random integer between 1 and 6, and PROCprint_out prints it out.

Now you could argue that the last two procedures were a bit of a waste of time, since the active ingredients only consisted of one line apiece.

However the program is easy to follow written that way and there's another advantage – now we know

```

10 REM PROGRAM VII
20 MODE 6
30 PROCinitialise
40 REPEAT
50 PROCinput
60 PROCchoose_die
70 PROCprint_out
80 UNTIL FALSE
90 REM =====
100 DEF PROCinput
110 PRINT "Press space bar to
throw"
120 REPEAT
130 dummy%=GET$
140 UNTIL dummy%=CHR$(32)
150 ENDPROC
160 REM =====
170 DEF PROCchoose_die
180 die%=RND(6)
190 ENDPROC
200 REM =====
210 DEF PROCinitialise
220 DIM line$(18)
230 FOR loop%=1 TO 18
240 READ line$(loop%)
250 NEXT loop%
260 ENDPROC
270 REM =====
280 DEF PROCprint_out
290 PRINT "You threw "
300 PRINT line$(die%*3-2)
310 PRINT line$(die%*3-1), die%
320 PRINT line$(die%*3)
330 ENDPROC
340 REM =====
350 DATA " ", "*", " ", " "
360 DATA "* ", " ", " ", " "
370 DATA "* ", " ", " ", " "
380 DATA "* *", " ", " ", "* "
390 DATA "* *", " ", " ", "* "
400 DATA "****", "****", "****"

```

we've got the main structure of our program up and running, we can add to it.

For instance, PROCprint_out is rather dull visually. After all, we're supposed to be throwing a die – why not print it on the screen?

Well, since we know the program works, we can begin to tinker with PROCprint_out confident of success.

Program VII shows the outcome of this tinkering.

The main problems are how to draw the face that comes up, and how to pick the correct face to draw.

The eventual solutions I chose aren't the most elegant, but they do illustrate several of the things we've been covering lately.

Now each face of a die consists of three lines of information.

For example a six has three rows of three spots – I used asterisks – as in:

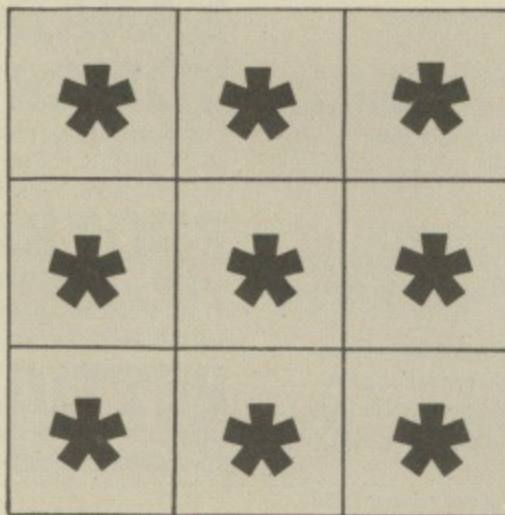

You could consider a one as having three rows – two of them blank and the middle one with a central asterisk:

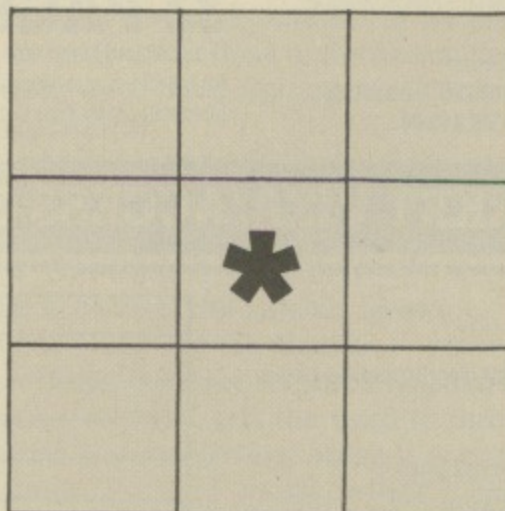

All in all you'd need 18 lines – three for each face of the die.

If you look in the data statements at the end of the program – lines 350 to

400 – you'll find 18 strings, each three characters long, in sets of three.

Each set corresponds to one face of the die. Line 350 holds the three lines for a 1, line 360 the lines for 2 and so on.

In PROCinitialise we dimension line\$() and read into it the 18 pieces of data.

This means that line\$(1), line\$(2) and line\$(3) hold the face data for a throw of one.

The following table relates the subscripts of line\$() to the face values:

line\$()	face
1,2,3	1
4,5,6	2
7,8,9	3
10,11,12	4
13,14,15	5
16,17,18	6

So, to produce a 4 on the screen we would print line\$(10) followed by line\$(11) then line\$(12), one under the other.

The second problem now becomes how to select the correct three values of line\$() corresponding to the face selected in PROCchoose_die – held in the variable die%.

Lines 300 to 320 in PROCprint_out accomplish this. This may look a bit complex at first, but if you try various values of die% in the lines you'll see that the correct face is printed.

For instance, if die% had the value 1, the lines in question would boil down to:

```

300 PRINT line$(1)
310 PRINT line$(2), die%
320 PRINT line$(3)

```

Which is the correct face.

Try it for other values of die% and you'll soon get a feel of how it works.

Incidentally, the die% tagged onto the end of line 310 is just so we print out the figure as well as the face.

Don't worry if it takes a while to work it all out – this is the most complex piece of programming we've done.

Notice that PROCinput and PROCchoose_die, our tried and trusted procedures from Program VI, remain unchanged.

Well, that's enough for this month – as I'm sure you'll agree!

Next month we'll use our growing programming prowess to explore other useful Basic techniques.



Watford Electronics

Dept. BBC, 250, HIGH STREET, WATFORD, ENGLAND.

Tel: Watford (0923) 40588/37774

Telex: 8956095 WAELEC

ACCESS ORDERS Tel: (0923) 50234



SPECIAL OFFER

BBC Micro (Model B)

New Low Price Only: £315

6502 2nd PROCESSOR **£175**
Z80 2nd PROCESSOR **£339**

TORCH Z80 DISC Pack **£695**
TORCH Z80 2nd Processor **ONLY £295**

BBC Micro with ECONET **£375**
ECONET Upgrade Kit **£55**
File Server Level 1 **£85**
File Server Level 2 **£215**
Printer Server EPROM **£41**
Clock Terminators (1 pair) **£95**
10 Station Lead Set **£25**
ECONET User Guide and Cable **£10**
TELETEXT Adaptor **£195**
Acorn Bitstick **£328**

Dust Cover for BBC Micro

Protects your expensive Micro from foreign bodies while not in use. **£3.50**

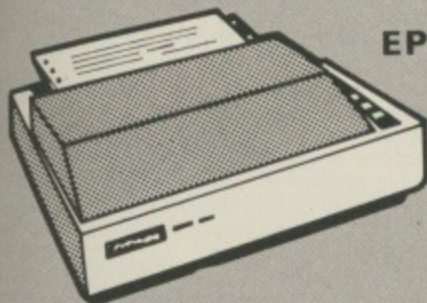

EPSON

- EPSON RX80 Printer **£229**
- EPSON RX80 F/T Printer **£245**
- EPSON FX80 Printer **£316**
- EPSON FX100 Printer **£435**
- SEIKOSHA GP100A **£122**
- Centronics PRINTER CABLE for all the above printers to interface with the BBC Micro **£7**
(Securicor carriage charge on printers £7)

RX & FX PRINTER INTERFACES

Epson interfaces fit inside the printer to allow connection using techniques other than Centronics.

RS232 **£35** RS232 + 2K Buffer **£59**
IEEE 488 **£65** 2K Parallel **£58**

PRINTER INTERFACE BUFFER

This neatly packaged, self-contained unit is supplied complete with all leads, operating manual and power supply. Computer output to the printer is stored in the buffer so that the computer can continue with other tasks while the printer works from the stored contents in the buffer. 16K holds approximately 10 pages of A4, close to the full memory of Wordwise. The 48K model is very useful for extremely large documents that otherwise tie the computer up for hours while being printed.

Price: 16K **£115**
Price: 48K **£149**

Type	Ribbons	Dust Covers
MX80FT	£4.75	£4.50
MX100/FX100	£10.00	£5.25
FX80	£4.75	£4.95
RX80	£4.75	£4.50
GP80	£4.50	—
GP100	£4.95	£3.95
GP250	£5.95	£3.95
GP700	£18.50	—
KAGA KP810	£5.95	£4.75
CANON PW1080	£5.95	£4.75

PRINTER SHARER

This handy UNIT is a solid state switch system designed to ease the problems of short printer leads, continual plugging and unplugging of leads, and costly extra printers by allowing up to three computers to be connected to one printer. It has four parallel Centronics connectors for easy interfacing of the BBC micro to any printer with a Centronics capability such as daisy wheel, dot matrix or plotter type printers. PRINTSHARER is ideal for schools and colleges for sharing their printing resources.

Price: **£65** (£2 Carr.)

BROTHER HR-15 DAISY-WHEEL PRINTER

This is a high-quality daisy-wheel printer, for the price of a dot matrix. Daisy-wheel quality gives a professional look to your correspondence. Facilities include 18CPS, bi-directional print, 3K Buffer with clear facility, carriage skip movement, text copy switch, proportional spacing, underlining, bold, shadow, super and sub-script, printing in two colours. Impact control allows use of carbon paper. Connects directly to the BBC micro with centronics parallel interface. RS232 interface is an optional extra. Other options are a single sheet feeder that automatically feeds up to 150 single A4 sheets and a keyboard to transform the printer into a sophisticated electronic typewriter.

SPECIAL OFFER ONLY £339 (carr. £7)

Single Sheet Feeder **£195**
Electronics KEYBOARD **£135**
TRACTOR FEED Attachment **£90**

RIBBON CARTRIDGES:
Fabric **£3**; Carbon **£3**; Multistrike **£6**
DAISYWHEELS (various typefaces) **£18**

LISTING PAPER (Plain)

1,000 Sheets 9½" Fanfold Paper **£7**
2,000 Sheets 9½" Fanfold Paper **£13**
1,000 Sheets 15" Fanfold Paper **£9**
Teleprinter Roll (Econo paper) **£4**

PRINTER LABELS

(On continuous fanfold backing sheet)

1,000 90 x 36mm **£5.50**
1,000 90 x 49mm **£7.75**
1,000 102 x 36mm **£6.25**

Carriage on Printer Paper or Labels **£1.50**

All prices exclude VAT

NEW

DPW1 120

DAISYWHEEL PRINTER

At last a low cost, high quality daisy wheel printer that everyone can afford, yet there are no compromise in facilities available - 20 CPS, bi directional, logic seeking, print 10, 12 & 15 pitch, proportional spacing, QUME Protocols, QUME Ribbon, QUME Daisywheel 96 characters, maximum characters per line: 180 at 1/15" pitch, copy capacity: 4 copies Centronics Interface, Supports all Wordstar features, paper width 13" max., Optional extras: RS232-C Interface, tractor feed attachment, single sheet feeder.

Amazing Introductory Offer:

£185 (£7 carr.)

KAGA KP810

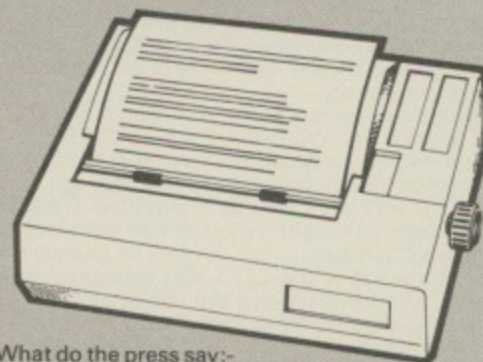

What do the press say:-
"At £269 this is an unbeatable product for what it has to offer." - Educational Computing.
"Offers excellent value for money." - Electronics & Computing.

This new Japanese printer has EPSON FX/RX compatible control codes and is functionally equivalent to an FX80 with the added advantage of its 'Near Letter Quality' mode. It is solidly built and features include: Normal, Italic, Enlarged, super/subscript, proportional spacing and user-defined character set. Extras over the FX80 included in the price are Near Letter Quality (NLQ) print ideal for correspondence, properadjustable tractor feed, half speed/quiet mode and 3K buffer. The printer is bi-directional and logic seeking to give a speed of 140CPS for high throughput in conjunction with the standard 3K buffer. 8K RAM may be added to give more user-defined character sets. Centronics parallel interface + Watford's 12 month NO QUIBBLE WARRANTY.

Special Offer: **ONLY £246**

RS232 interface + 2K buffer to connect to other micros

£89

KAGA KP910 PRINTER

Very similar to the KP810 but with 17" carriage for really wide print. Gives 156 columns of normal print or 256 columns in condensed mode. This printer is ideal for printing out spreadsheets and can also be used for correspondence in NLQ mode.

ONLY £349

PRINTER LEAD 36"

Centronics lead to connect BBC micro to EPSON, KAGA, SEIKOSHA, NEC, STAR, JUKI, BROTHER, SHINWA etc. printers.

STANDARD (3 foot long) **£7**
EXTRA LONG (5 foot long) **£10**

Continued →

DOUBLE DENSITY DISC INTERFACE

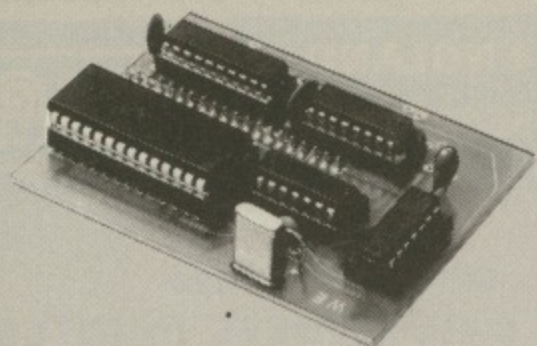

SIMPLE but SOPHISTICATED

We are proud to announce the launch of the Watford Electronics Double Density Board for the BBC micro. The DDFS supplied is a new version of the popular Watford Electronics DFS re-written to make full use of the capabilities of the new double density controller.

- Storage is increased by the maximum physically possible, 80%.
 - Our system will use the whole of an 80 track drive. Inferior systems do not allow files longer than &3FFFF bytes, but with our system files can be as long as one disc side.
 - Discs may be created in either single or double density format with the built in formatter and in single density mode are fully compatible with normal Acorn format discs.
 - The density of the disc you put in is automatically sensed by the system and you are informed of the density in the catalogue display.
 - The double density system is of course faster than single density.
- Worried about compatibility with single density discs? Don't. The Watford Electronics DDFS implements an extremely comprehensive 8271 emulator so that commands passed through OSWORD &7F are correctly interpreted. Other manufacturers thought that read and write sector alone were sufficient - we decided to implement every command of the 8271 that was physically possible. We have allowed the use of all the special registers including bad tracks, allowed access to deleted data etc., etc. The emulator itself takes up around 1K of compactly written machine code. We reckon it will run the vast majority of protected discs now available. Gain all the advantages of the WE DFS together with much increased storage and compatibility with existing protected discs. The price is the same as for the standard single density system that we continue to sell so you can choose between the two options without financial worries.

Complete Unit incl. DDFS ROM **£85**
 DDFS Manual **£6.95** (no VAT)
 We will exchange your existing Single Density Interface for our DDFS Unit for **£55**

SPECIAL OFFER

EPROMs for BBC Micro (Hitachi)
 2764-250nS **£4.95**
 27128-250nS **£16.00**
 RAMs for BBC Micro (Hitachi)
 6116L (2K) **£3.75**
 6264L (8K) **£24.00**

NEW DESIGN PLASTIC LIBRARY CASES

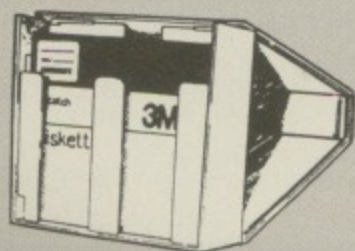

for Disc Storage 5 1/4" (holds 10) **£2**

DISC DRIVE PRICES SLASHED!

(All Drives are NEW SLIM-LINE Type)

NEW LOW PRICES



(DRIVES Cased with Cables; connects directly to your BBC Micro)

- **CLS 100** Single, TEC Single sided 40 track 100K, 5 1/4" Disc Drive **£99**
- **CLS200** Single Drive, Double sided 40 track, 200K, 5 1/4" **£129**
- **CLS400** Single, Mitsubishi Double sided 80 track 400K, 5 1/4" Disc Drive **£135**
- **CLS400S** Single, Mitsubishi Double sided 40/80 track Switchable, 400K, 5 1/4" Disc Drive **£159**
- **CLD200** TEC Single sided 40 track 200K, twin 5 1/4" Drives **£199**
- **CLD800** Mitsubishi Double sided 80 track 800K, 5 1/4" TWIN Drives **£269**
- **CLD800S** Mitsubishi Double sided 40/80 track switchable, 800K, Drives **£299**

(CUMANA) DRIVES CASED WITH PSU & CABLES



- **CS100** TEC Single sided 40 track 100K 5 1/4" Single Disc Drive **£125**
- **CS200** TEC Single sided 80 track 200K 5 1/4" Single Disc Drive **£149**
- **CS400** Mitsubishi Double sided 80 track 400K 5 1/4" Single Drive **£169**
- **CD200** TEC Single sided 40 track 200K 5 1/4" TWIN Disc Drives **£236**
- **CD400** EPSON Double sided 40 track 400K 5 1/4" TWIN Disc Drives **£299**
- **CD800** Mitsubishi Double sided 80 track 800K 5 1/4" TWIN Drives **£349**
- **CD800S** Mitsubishi Double sided 40/80 track Switchable 800K TWIN Drives **£425**
- SPARE DRIVE CABLES, SINGLE **£6**; DUAL **£8**
- DFS Manual (comprehensive) **£7.50** (No VAT)

P.S.

You do not require a formatting disc nor the expensive 40/80 track switchable drives if you use Watford's sophisticated Disc Filing System which has all these facilities in the ROM.

DUST COVERS

(For our Disc Drives)

- Single (without PSU) **£3.20**
- Twin (without PSU) **£3.85**
- Single (with PSU) **£3.25**
- Twin (with PSU) **£3.90**
- Twin (side by side with PSU) **£3.95**

5 1/4" DISKETTES

Top quality 3M and XIDEX diskettes with a lifetime guarantee. These discs are quiet in operation and insert positively with their reinforced hub rings. Boxes of 10 supplied with disk labels and write protect tabs.

- 10 SCOTCH / 3M + labels S/S S/D **£15**
- 10 SCOTCH / 3M + labels S/S D/D **£17**
- 10 SCOTCH / 3M + labels D/S D/D **£24**
- 10 XIDEX + labels S/S D/D **£15**
- 10 XIDEX + labels D/S D/D **£24**

DISC ALBUMS

Attractively finished in beige leather-look vinyl, these conveniently store up to 20 discs. Each disc can easily be seen through the clear view pockets.

£4.25

LOCKABLE DISK STORAGE UNITS

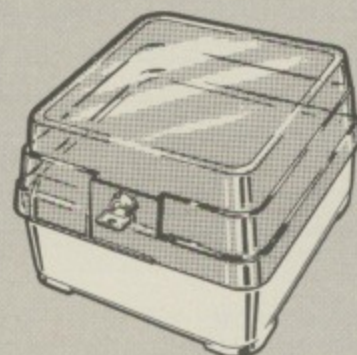

Strong plastic cases that afford real protection to your discs. The smoked top locks down. Dividers and adhesive title strips are supplied for efficient filing of discs.

M35 holds upto 40 discs **£13**

M85 holds upto 95 discs **£18**

FLOPPY HEAD CLEANER KIT

The heads in a floppy disc drive are precision made and very sensitive to dirt. Drive manufacturers recommend that you clean the heads approximately once a week. Unless your home or office is dust free one of these kits is a very sensible precaution against losing valuable data. A dirty head can destroy many disks before you realise the trouble. Very simple to use.

Only **£14**

BBC Micro WORD-PROCESSING PACKAGE

A complete word-processing package (which can be heavily modified to your requirements, maintaining the large discount). We supply everything you need to get a BBC micro running as a word-processor. Please call in for a demonstration.

EXAMPLE PACKAGE

BBC Model B, Watford Electronics' DFS upgrade, WORDWISE ROM, Twin 200k Teac drives in beige, Zenith 12" Hi-resolution monitor (Green or Amber), Brother HR15 daisywheel printer, Gemini software: BEEBCALC spreadsheet, analysis and DATABASE software on disc. 10 x 3M discs, 500 sheets fan-fold paper, 4 way mains trailing socket, manuals, all leads and BBC carrying case.

ONLY **£1,189** (£15 carr.)

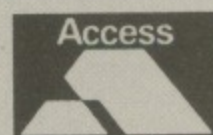

ACCESS HOT LINE
(0923 50234)
 24 Hours



£15
£17
£24
£15
£24

We stock a range of monitors to suit all needs. Choice of a monitor is a matter of personal taste so we recommend that whenever possible, you ask for a demonstration at our shop.

MICROVITEC

- 1431 - Medium resolution as used on the BBC television computer programme ... **£165**
- 1451 - High resolution, suitable for word processing in mode 0 ... **£255**
- 1441 - Super High res, exceeds the capabilities of the BBC micro ... **£385**
- Dust Cover for Microvitecs ... **£5.50**

All Microvitec monitors are 14" RGB in their distinctive right angled case. They come with the connecting lead to the BBC and a mains plug.

KAGA

- Standard resolution with RGB and composite video inputs ... **£195**
 - High resolution colour ... **£259**
- Kaga monitors are 12" RGB colour with antiglare screen and user access to screen controls.

ZENITH

12" Ultra high resolution monochrome monitor. Ideal for word processing as its green or amber screen is very restful to read. The high resolution makes it good for games too - you can really see the detail that has been put into the graphics. ... **ONLY £68**

PHILIP V2001

- 12" Green High resolution ... **£64**

LEADS

- BNC Lead for Zenith or Philips ... **£3**
- BNC for Zenith ... **£3**
- RGB lead for KAGA ... **£5**

N.B. Carriage on Monitors **£7** (securicor)

Versatile **BEEB SPEECH SYNTHESISER** Unit



SIMPLY the best! - An unlimited speech synthesis system. Complete with easy-to-follow manual. Controlling software is in ROM so no Cassette Loading problems!

PHONEMES for word synthesis - That means unlimited vocabulary! No extra speech dictionary chips to buy!

BUILT-in Library of approximately 500 words to get you started.

ENGLISH accent - Utilises inflexion techniques to produce highly comprehensible speech.

EASY to use system - Just plug the software ROM into a socket, the Speech unit into the User Port, and away you go! No specialised 'dealer upgrade' required!

COMPACT unit - The whole system is built into a small case - easily tucked behind the computer. Auxillary output socket provided for direct connection to an external amplifier.

HOURS of fun! - Suitable for any application - Games, Educational Programs, Specialised Packages.

We know this all seems to good to be true but **DON'T BE LEFT SPEECHLESS!** Order your Versatile Speech Unit now!

Only £44

Best cost less at WATFORD

WATFORD'S LAUNCH OF THE YEAR APEX

The ultimate expansion system for the BBC microcomputer. It enables you to increase memory capacity to 2+ MEGABYTES including BATTERY BACKED-UP RAM.

The system consists of a mother board which fits inside the BBC and further daughter cards can be connected externally. The internal card has the following features:

- 15 ROM/RAM sockets, 11 of which can be configured as 2716, 2732, 2764, 27128 EPROMS or ROM equivalent devices or as 6264 RAMs. Any RAM is Automatically battery backed-up and it's contents preserved when the power is turned off.

- The battery is recharged every time the machine is turned on and lasts several months, depending on the number of RAMs fitted.

- There is very little extra current drain, even with a fully loaded board as only the presently active ROM is powered up. In fact the fully populated board uses only 300mA.

- The board reduces micro bus loading by up to three ROM loads, which improves reliability and performance.

- Installation is extremely simple. There is no soldering required. The board is rigidly held by two 40 pin sockets and five support posts. A ribbon cable can be brought outside the computer and up to 8 external cards added. This enables the user to plug-in up to 142 paged ROMs. The cards have following features:

- Each card can accommodate up to 16 devices each of which can be configured as 2716, 2732, 2764, 27128 ROMs or 6264 8K RAMs.

- Battery backup is provided from the internal card.

- Only the active ROM is powered up permitting many external ROMs to be added with very little current loading (100mA per card).

The system comes with controlling software in ROM. The utilities supplied are as follows:

- ★ **APEX** - replies with the device number currently being accessed.
- ★ **APEX C** - toggles between the colour and standard black and white messages.
- ★ **AL** - loads from any device, regardless of the data type.
- ★ **AS** - saves memory to any specified RAM device.
- ★ **AD** - prints a directory of the devices present in the system, i.e. ROMs present and files stored. This also reports on the amount of free storage space.
- ★ **AF** - asks for the free RAM devices.
- ★ **LA** - repeats the last command to paged ROMs.

Continued

★ **AT** - enters a memory testing routine. This will write a test pattern into the memory and read it back out again. If a fault is found, it is reported to the user. This test continues until Escape is pressed.

● **RDISC** - activates APEX as a filing system which then treats all free APEX RAM in the system as a continuous 'RAM-DISC'. All commands have similar format to the DFS and transfer is possible between the two systems.

The complete computer system bus is available to the user, so that other cards/devices could be added such as EPROM programmers, second processors, Winchester disc drives, clocks, etc. By racking the cards you eliminate the tangled mass of cables that usually accumulates around the micro.

A comprehensive operating manual is supplied with every APEX Board. Please write in for further details and prices.

THE ULTIMATE DFS FOR BBC MICRO

by

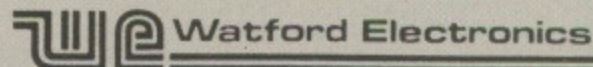

Highly acclaimed at The ACORN and BBC MICRO USER Shows. What do the independent press say?

Good value for money - *Beebug Aug. '83*
A very worthwhile package - *The Micro User*

You'll be buying a very powerful package - *Personal Computer News*

Superior DFS; Excellent disc sector editor - *Computer Answers*

Without a doubt, the most sophisticated DFS Software yet written for BBC Micro Computer. This powerful new DFS is fully compatible with ACORN DFS yet has much increased power due to additions, carefully designed to make life easier in normal use. It consists of over 14K of efficiently written machine code. It is entirely self contained and so does not require a utilities disc to function.

Please write in for full technical specification.

PRICES:

DFS (Disc Filing System) ROM **£25**

Complete Disc Interface Kit including DFS ROM & Fitting instructions £99

Disc Filing System Manual. Comprehensive and clearly written **£7.50** (no VAT)

P.S. We will exchange your existing ACORN DFS or PACE (AMCOM) DFS for Watford's highly sophisticated 16K DFS ROM for **£19**

Watford's DFS is exclusively available from Watford Electronics. We do NOT retail through any dealers. Every ROM carries a label with our LOGO and a serial number.

Now available:
Acorn DFS Kit **£99**

EPROMs & CMOS RAMs NEW LOW PRICES

2764-250nS (8K ROM)	£5.25
27128-250nS (16K ROM)	£19
6116-150nS (2K RAM Low Power)	£5.25
6264-150nS (8K RAM Low Power)	£28

Continued →

BEEB PRINTER ROM



This utility ROM is designed to simplify using all the facilities of your printer. It has many facilities:

- ★ Selection of printer modes such as underline, font and size is by 'Single Key' operations.
 - ★ From Wordwise, a single number following OC will select a mode rather than a long and incomprehensible string of control codes. This makes using your printer with Wordwise much more convenient.
 - ★ When using Basic (or other languages) you can have control over the formatting of the output to the printer in the style of a wordprocessor. You can define page top, bottom and side margins etc. with intelligent page skip for binders an option. All supported printers will now respond to form-feed etc. commands.
 - ★ User defined characters are printed as you see them on the screen so that non-standard characters are automatically printed out correctly.
 - ★ Commands select the options for the following printers:
GP100, STAR, NEC, MX/FX, KAGA, LP/VII/DMP100, DMP200.
- Operates with either parallel or serial interfaces.
- ★ Supplied with a 50 page manual that is very comprehensive and easy to follow. Please specify printer type when ordering so that we can send the correct function key strip.

Price: £24

DUMPOUT 3

A highly sophisticated screen dump ROM. This has to be the most flexible and powerful screen dump ROM yet produced for the BBC micro. It will put on paper anything you see on the screen, including all Mode 7 facilities etc. We have to admit that there is one facility that we cannot replicate - if anyone can supply flashing ink we would like to know!

The ROM also provides window setting facilities and two new OSWORD calls that allow mode 7 graphics pixels to be read and plotted using the standard graphic co-ordinate system. Two commands are used to operate the dump routines:

- *GIMAGE - This provides a full graphics dump of any Mode (including Mode 8). There are various optional parameters but you need only specify the parameters you wish to change.
- V <scale>, H <scale> - These 2 byte numbers give fine control over the size of the dump from minute to enormous. Unlike other dump ROMs the scale does not change with mode.
- R <0-3> - Print dump rotated by 0.90, 180, 270 degrees.
- I <indent> - Set gap from left edge of paper.
- X <min>, <max>, Y <min>, <max> - The whole of the screen graphics window area is dumped except when these parameters are given.
- P - Physical colour values are used for plotting, otherwise a negative scale is used (white darkest).
- T Two tone dump for maximum resolution.
- M <mask> - 8 bit colour mask.
- E - Contrast expansion to make mode 7 text and separated graphics stand out from the background.
- C - All mode 7 graphics are printed as contiguous to improve the shading in graphic areas.

*TIMAGE <indent> - Does a fast, text only, dump of the contents of the text window in any mode.

*GWINDOW and *TWINDOW - These commands draw the graphics and text windows, respectively, on the screen and allow them to be changed with the cursor keys. N.B. GIMAGE and GWINDOW work fully in mode 7.

Designed for use with the following printers:
CP80, GP80, GP100, GP250, STAR, KAGA/TAXAN, NEC, SHINWA, GEMINI, EPSON MX/RX/FX, LPVII, DMP 100/120/200/400, CANON.

Price including comprehensive manual
£22

APPROVED for use with telecommunication systems run by British Telecommunications in accordance with the conditions in the instructions for use.

MODEM 84

PRESTEL TERMINAL
For the BBC Microcomputer

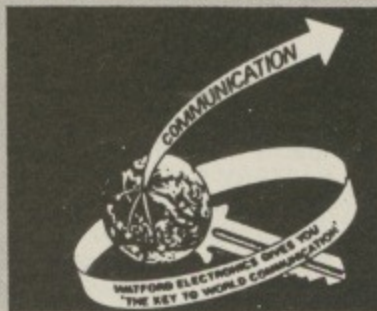

The Watford Prestel package allows B.T. approved connection to Prestel, Micronet and many other 1200/75 baud databases for about the cost of a good tape recorder. Prestel gives you access to an incomparable database covering almost every subject under the sun. There is Micronet with lots of free programs that you can download and run. Details of clubs and user groups, a diary of meetings and exhibitions, news and reviews, technical information etc. There is Homelink with online banking. And there is armchair shopping, travel information, entertainment, world news, sports news, weather information, electronic mail and lots more.

The basic Prestel subscription is only £5 per quarter and at off peak times there is no charge for access time. A local phone call facility means no long distance phone calls to Prestel (approx. phone cost is only 40p per hour).

The Watford Prestel package consists of the B.T. approved Watford MODEM 84 (1200/75 baud full duplex 1200 baud half duplex direct connect) and a very sophisticated Prestel Terminal ROM.

This totally machine code software:

- is fully compatible with not only the Modem 84 but also with the PRISM 1000 and most other modems that require a data link via an RS423/RS232 port making it a worthwhile purchase for those who already have Modems.
- supports full Prestel colour alpha and graphic characters including double height, flashing, conceal/reveal.
- called by simple *PRESTEL (*P.) command. Disc and tape configurations fully supported.
- includes a comprehensive telesoftware downloader for BBC and other programs with continuous on screen status report (an essential facility).
- has very powerful OFF LINE MAILBOX editor allowing colour flashing graphic mailboxes to be prepared without having to be on line to Prestel.
- auto logon sequence can be burnt into ROM if desired.
- a vital 'TAG' facility allows tagging and recall of interesting pages, avoids that common and annoying 'NOW WHERE WAS THAT PAGE' problem.
- includes simple page and program loading and saving functions for both disc and tape, automatically assigning frame and program directories.
- not one but TWO PRINTER DUMP ROUTINES are provided within the software allowing either full graphics dump (mode 7 to EPSON compatible printers) or ASCII characters only.
- a user function built into the software allows interface with specialist routines, (yours as well as ours).

EPSON DUMP ROM

This screen dump ROM is specifically designed for use with the Epson RX/FX printers and the Kaga KP810. It is extremely simple to use as there is only one command to remember. It will accurately dump any screen mode using multiple tones as required. Mode 7 is fully supported giving teletext graphics, double height etc. For those who like to keep life simple this EPROM is only

£20.

FORTH ROM for BBC

This ROM provides a complete implementation of the FIG-FORTH standard (including editor). Supplied with a large tutorial manual at only

£33

TINY PASCAL for BBC Micro £59

- All the above facilities are accessed via function keys. An overlay is provided to give comprehensive guidance to key functions.
- A 34 page comprehensive instruction/operating manual is supplied.

WATFORD'S 1200 BAUD FULLY AUTOMATIC USER TO USER SOFTWARE

Having purchased the WATFORD PRESTEL TERMINAL which includes the 1200/75 baud MODEM 84 the addition of the WATFORD user to user ROM based software enables you to discover a whole new world of data communication.

This software enables you to use the MODEM 84 very powerfully.

- Send and receive error checked programs and files (even WORDWISE files) to and from other users at 1200 baud.
- 8k file transfer in under 2.5 minutes (approx four times faster than with 300 baud modems).
- The transfer of data is totally AUTOMATIC which means that the modem is automatically switched between transmit and receive under software control.
- A chat mode is provided which also has this automatic switching for receive and transmit. (This mode is essential just before and after data transfer when both hand sets are replaced to reduce noise).
- A copy facility is provided which allows transmission of all screen output.
- A continuous on screen modem status report is included.
- The software is totally function key driven enabling easy transmission, reception, saving and loading of programs and files (Basic, Machine code or Data).
- A help menu is available from within the software as an aid to use.
- Full instructions are supplied.

PRICES

MODEM 84 (with Lead & Manual)	£68
MODEM 84 complete with PRESTEL SOFTWARE ROM, Lead and Manuals	£82
PRESTEL SOFTWARE ROM + Manual	£20
USER to USER SOFTWARE ROM	£15
(Carriage on Modem £2)	

VIEW

VIEW WORDPROCESSOR

We are supplying the new VIEW version 2.1 allowing printing of memory contents etc. . . £49

FX80 PRINTER DRIVER

Watford's own Sophisticated VIEW Printer Driver for FX80

To simplify using the full facilities of the Epson FX80 or Kaga KP810 use this printer driver. Full facilities are provided for selecting between fonts etc. The disc includes examples of use and instructions. Available on 40 or 80 track disc (please state which required). £6

VIEW PRINTER DRIVER FOR SILVER REED

(Officially approved by Silver Reed)

A range of VIEW Printer drivers to complement the Silver Reed range of Printers and Typewriters. The View driver allows access to all of the features supported by the range of daisy wheel printers (EXP 770/400/500/550). These include underlining, bold, shadow, superscript, and subscript printing. Additionally, you can use proportional spacing on the EXP 770. Owners of one of the typewriters in the range EX 55/44/43, using it as a printer, can also access underlining with these drivers. The features of each printer/typewriter are accessible from the two highlight codes, which can be redefined at any point within the text. The printer drivers also extend the facilities in View to allow the use of pad characters. The printer driver on disk with a user manual is at a special introductory price of £7.50. Please specify printer type when ordering.

TWO DATABASE MANAGEMENT SYSTEMS

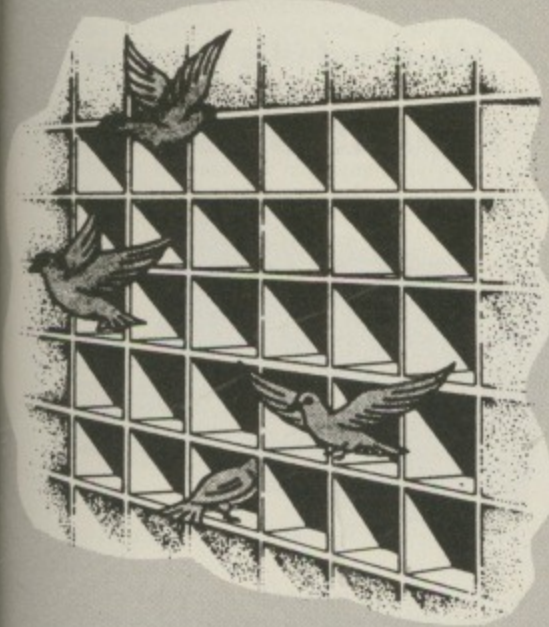

DISCDATA

Discdata is an entirely disc based database handling system. It is extremely easy to use through its comprehensive menu system. The simplicity is such that we do not feel the need to provide explanation on use in the written guidance supplied with the program. The first-time database user will rapidly become familiar with this package designed throughout to be simple and obvious.

Despite the ease of use this system provides all the facilities needed for complex data handling problems. The length of database that can be handled is only limited by the total space on the disc. You can have up to 20 fields with page length records up to 254 bytes in length. Adding and deleting records, amend titles, field names and records. Sort on any field and search for any record or group of records in any field. The database may be re-formatted after creation, the system will re-write all your files for you automatically. You may add extra fields and extend the length of existing fields freely. Output formatting is very powerful. You are allowed 40, 80 or 132 column output modes going to printer or screen. Selected fields can be put in any order on the screen or printer, either across the paper or down. Output can start or stop anywhere in the file. Decimal fields are automatically totalled and records output are counted. Version 2, now on sale has improved input and amendments procedures giving full record edit as well as the 3 extra features... String searching, Calculations on numeric fields, and the ability to create sub files from your main files.

On disc at **Only £17**
(Please specify 40 or 80 track when ordering)

FILE-PLUS

The File-Plus package is even more powerful and flexible than Disc-Data. It is also largely menu driven but has its own command language for file searching. The 16K ROM contains all the normally required routines, with lesser used options supplied on the utilities disc. All input and output formatting is controlled through screen forms. A full screen editing system is used to define a form which allows tremendous flexibility in the format in which your data is displayed. It is very easy to change from form to form so that you can type in your data with one form, and examine it with others. You will typically design several forms before starting to access the database so that you can quickly and easily see the fields of each record that you want to appear in the layout you decide on. The form system is also used for output to your printer. File Plus has a unique file linking system that allows the entire on-line storage of your system to be used for one database. This can give around 1.5 Megabyte databases using dual drives and double density.

The built in FQL (File-Plus Query Language) can be used for searching the database. Presented in the form of a powerful command language with looping facilities etc. this allows the most flexible access to your data possible. Full arithmetic operations are provided to allow the system to be used for statistical analysis.

Cont.

Operations supported are -, +, *, /, +---9999999999.9999 and compare facilities =, >, <, <=, >=, <, &..

Many keywords are supported by the language: assign, compare, display, end, goto, iff, ift, print, read, search, spool and update. Supplied with a very detailed 70 page manual to explain all the facilities with many examples.

Only £43

(Please specify 40 or 80 tracks for the utilities disc)

BUFFER & BACKUP ROM

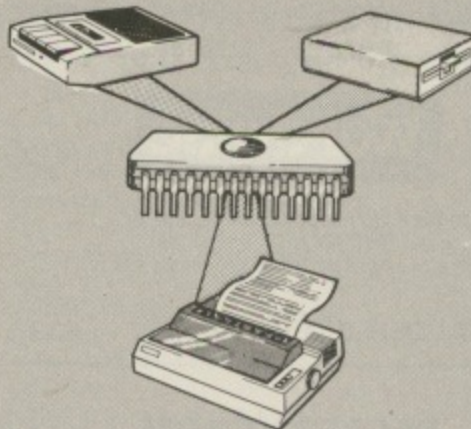

For those with sideways RAM fitted in their machines this utility ROM will make full use of this facility. By using the sideways RAM area for extra memory the following features are implemented:

- ★ 4K or 16K buffer for parallel printer.
- ★ Dumps selection of Disc files to Tape.
- ★ Makes backup copies of tapes on to tape and disc.
- ★ Displays contents of paged ROMs on screen.
- ★ Menu display of ROM filing system contents on Shift-Break.
- ★ Comprehensive manual.

Only £22

DATAGEM

Gemini's 24K ROM based DATABASE Management System

Special Introductory Offer: **£99**

PEN PAL - VERSATILE LIGHT PEN SOFTWARE

Do you have a light pen that never gets used? Then this piece of software is for you. This package offers many useful facilities that make the light pen a useful device to own. Facilities included are:

- Pixel, Line and Character definition
- Free hand drawing
- All Colours
- Fill, Refill and stripes
- User defined "Brush strokes" plus character definer
- Grid, Scale and perspective aids 2 to 200 points pallettable in one design with Circles and "rubber banding"
- Move design/character to any screen position
- Save and Load screens, User defined characters and line drawings for video titles, own programmes etc.

This program has many uses in education and at home. It is supplied with a comprehensive instruction manual.

Works with Watford, RH, Acorn User, DIY and many other Light Pens.

Prices
TAPE **£10**
DISC (40 or 80) **£11**

DISC EXECUTOR

Disc Executor is a sophisticated disc utility for the transfer of your cassette programs to disc. If you have difficulties transferring your cassette software to your disc system then this is the answer. It handles 'locked' files and full length adventures (up to &E blocks) and programs that load below &E00. It is very simple to operate with instructions supplied. It saves you time and money.

Price £10

(Please specify 40 or 80 track discs)

ADE

Complete program development package in a 16K ROM. Full assembling and debugging facilities provided.

SPECIAL OFFER ONLY £43

ROM MANAGER

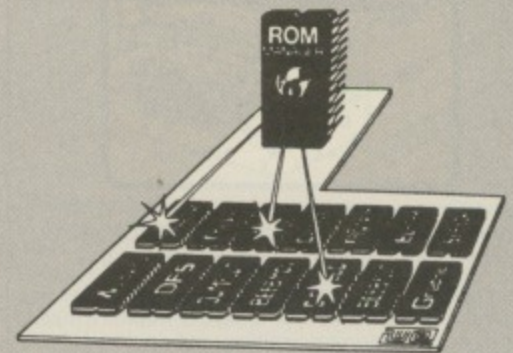

This ROM is unique in its capabilities. It allows you, the user, full control over the BBC Micro's sideways ROM paging system with simple to use commands. This ROM is essential for those with several ROMs. At a simple level ROM MANAGER can be used to remove the problem of clashing command names and allow full use of all the facilities of your ROMs. This is coupled with facilities to completely enable or disable various ROMs in the machine including ROM manager itself.

ROM MANAGER can also be used to develop sideways ROMs using the machine's standard memory. This is achieved by sending sideways ROM calls to your code in RAM, saving the expense of fitting sideways RAM for ROM development purposes. ROM status reports are also given by the ROM, including ROM lengths, checksums, entry points supported and current filing system title.

The ROM also provides facilities to examine ROMs, list function keys for editing, modify RAM (using a HEX/ASCII editor) and list ROM titles neatly and concisely.

The commands given in the ROM:

- **CHECKSUM** - Generates a CRC for a specified ROM (useful for testing suspected faulty ROMs).
 - **DIRECT** - Passes a command directly to a named ROM (overcomes command name clashes).
 - **EXAMINE** - Allows examination of a named ROM
 - **EXPLAIN** - Gives detailed explanation of the first 22 *FX codes.
 - **FILE** - Passes a command directly to the current filing system (which normally receives commands after all the ROMs).
 - **FUNCTION** - Lists the contents of the function keys in a form suitable for editing.
 - **INCLUDE** - Allows the main memory to be used for ROM development.
 - **MODIFY** - Memory editing in HEX/ASCII format.
 - **NAMES** - Lists the names and socket numbers of all resident ROMs.
 - **RAM** - Sends command directly to the RAM based ROM routine.
 - **REMOVE** - Removes RAM based ROM option.
 - **SPECIFY** - Selects the default ROM.
 - **DEFAULT** - Sends commands directly to the default ROM without having to give its name.
 - **STOP and *START** - Disable and enable any named ROM to completely eliminate command word clashes.
 - **STATUS** - Information about all the ROMs fitted in the machine including socket number, name, length, whether it is enabled, whether it has service or language entries etc.
 - **VALUES** - Gives ROM MANAGER status information, such as its socket number, how many ROMs have higher priority, number of default ROM and the identity of the current filing system.
 - **VECTOR** - Same as *DIRECT, just in case *DIRECT clashes with another ROM.
- All selection between particular ROMs is by the name of the ROM and this may be abbreviated for convenience. ROM numbers can also be used if required. This ROM is very simple and obvious to use. All the facilities are explained in the clear and detailed manual.

Price £22

Continued →

BEEB MON

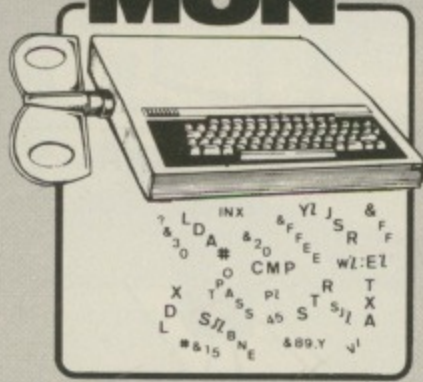

Watford's own Machine code Monitor ROM written by Andrew Bray (Cambridge), co-author of the BBC Micro Advance User Guide.

The most powerful and versatile machine code monitor ROM yet written for BBC Micro. It has all the normal memory editing, moving and relocating facilities, plus all editing is with a full screen editor allowing scrolling up and down memory, entering in Hex, ASCII or standard assembler mnemonics.

In use as a debugging tool, you run code under a total emulation system. Ever felt a desperate urge to set a break point in ROM? No problem - you can even have breakpoint on reading or writing locations in memory and on register contents. The system fully supports debugging of sideways ROMs e.g. BASIC can fully and easily be run from within Beebmon and from there DFS and other sideways ROMs can be used in total emulation mode.

Beebmon can even run itself. In so doing you can nest Beebmon up to a level limited only by the memory size. Beebmon uses 256 bytes of workspace, located anywhere in memory, even on the 1MHz Bus. Beebmon effectively uses no zero page workspace, so your program (e.g. BASIC) can use any or all of the base page. How does it achieve this? By providing a 6502 interpreter all programs running under it exist in a virtual BBC, so special memory locations like the ROM latch are not actually accessed by your programs, instead they alter a location in Beebmon's workspace. Emulation also allows immediate return to Beebmon command level by ctrl-escape no matter what code is being executed at the time. All this exceptional power and flexibility is complemented by a clear and detailed manual included in a value for money price of:

£22

Disassembler Rom



Discover the hidden secrets of BASIC and the OPERATING SYSTEM with this easy to use programmers tool.

A ROM based machine code Disassembler for the BBC micro. It enables machine code programs to be listed in BASIC/DUMP format and thus is the perfect complement to the built in assembler. It allows Sideways ROMs, files on disk or tape to be listed, and also has a comprehensive editor, allowing mnemonics to be altered directly, as well as HEX, DECIMAL, ASCII and BINARY memory editing. There is also a full set of labelling facilities available (up to 3,200 labels), with the major locations and routines already labelled.

Thus DIS-ASM enables any monitor program, such as BEEBMON to be used to much greater effect as it is not necessary to disassemble memory each time the display is altered.

ONLY £18

WATFORD - Always a step ahead

COMPUTER CONCEPT'S ROMS

CARETAKER Basic Utility	£28
Graphics ROM	£28
Disc Doctor ROM	£28

Wordwise

Without doubt a very sophisticated piece of software for the BBC Micro. It has all the features of a professional word processor yet is easy to use.

SPECIAL OFFER THIS MONTH: £32

BEEBFONT ROM

BEEBFONT is a remarkable and different concept in BBC software supplied on a 16K ROM. It allows you to display text on the screen in any of the following styles:

ABCDEFGHIJKLMNPO
 abcdefghijklmnop
 ABCDEFGHIJKLMNPO

ABCDEFGHIJKLMNPO
 abcdefghijklmnop
 ABCDEFGHIJKLMNPO

ABCDEFGHIJKLMNPO
 abcdefghijklmnop
 ABCDEFGHIJKLMNPO

ABCDEFGHIJKLMNPO
 abcdefghijklmnop
 ABCDEFGHIJKLMNPO

ABCDEFGHIJKLMNPO

It works in modes 0, 1, 2 and 4 using the full colour capabilities of each mode. Characters are printed in the same way as normal. Selection between the various fonts is very easily achieved with Ctrl-V - press this followed by a font number and the output will continue in the new font. Beebfont ROM is particularly useful in display work with the characters produced at twice the normal size.

You can create your own character fonts with the editor supplied. You can also print-out pre-formatted text files using the special characters with Epson FX, RX and NEC printers. The full range of character styles can be used, controlled from within the text. The editor and spooler program are supplied with the package, on cassette or disc. The spooler allows word processor (Wordwise & View) output to be printed in the new characters.

A twenty page manual is supplied. Please state printer type and media for the editor & spooler when ordering (cassette, 40 or 80 track disc).

ONLY £39

NEW LAUNCH

Watford fills the gap with a 32K RAM EXPANSION BOARD

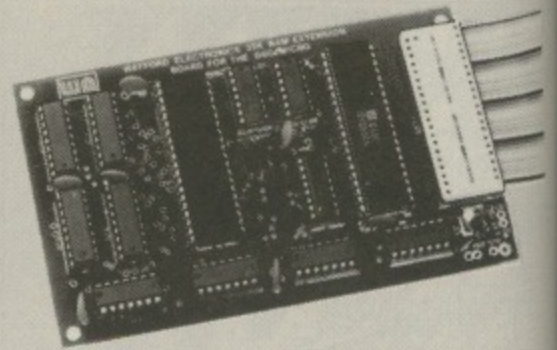

Now Watford Electronics brings you the latest state-of-the-art memory expansion board for your BBC microcomputer. This compact board which fits inside the computer does not just give you 16K or even 20K of extra RAM, but a massive 32K!!!

There are many useful facilities available with this board:

- The top 20K of the expansion RAM can be used as the screen display memory, leaving all the standard BBC RAM free for programs or data storage. This allows good graphics and long programs to be combined. For instance you could have MODE 0/1/2 GRAPHICS AND 28K OF PROGRAM SPACE. The extra memory can be used by virtually any language or utility such as BASIC, VIEW, WORDWISE, etc.

- The full 32K or the bottom 12K of the expansion RAM can be used as a buffer for the printer, sound channels, RS423, keyboard or speech synthesiser. This allows very long text files to be printed while you are using 27K of program and 20K of graphics!

- This board is the ideal complement to any word processing system. There is no need to wait for slow printers as you can type in long text in 80 column display mode while printing is going on - TWO JOBS DONE SIMULTANEOUSLY!!! (an equivalent printer buffer would cost you £115+).

- The board is compatible with a vast range of software and hardware available for the BBC microcomputer, including our ROM expansion board and double density DFS.

- The board is extremely easy to fit. It is supplied complete with a comprehensive manual and ROM based software with full *HELP messages.

SPECIAL OFFER

Only: £69 (carr. £1)

GRAPH PAD

With this popular British Micro's Graph-pad, you can add new dimension to your computer enjoyment. It helps you to create your own application programs by the simple use of the Graphpad. Ideal for Educational use. Supplied complete with Cables, Manual and a two program cassette.

SPECIAL OFFER £105

All Prices Exclude VAT

SURGE PROTECTOR Plug

Fitted in place of your normal mains plug, this device protects your equipment against mains surges. Nearby lightning strikes, thermostats switching and many other sources put high voltage transient spikes on to the mains. This can lead to data corruption in memory and on disc and can result in spuriously crashing machines. Suitable for computers, Hi-Fi, Fridge Freezers etc. Max. Surge current 2KAmp; max. Voltage 250. Essential for serious computer users.

Protection for only **£8.50**

NEW
LAUNCH

SIDEWAYS ZIF

External sideways
ROM socket

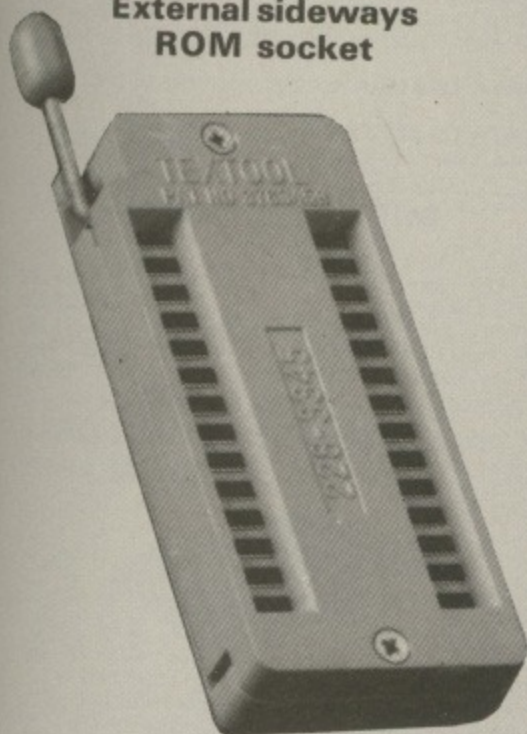

At Watford we haven't forgotten those of you with small budgets, so we've produced a ROM board which takes only one ROM! But don't stop reading - this ROM can be changed in under five seconds without taking the case apart. The SIDEWAYS ZIF eliminates the possibility of damage to your ROMs as zero insertion or extraction force is required when changing ROMs.

Included in the SIDEWAYS ZIF package is a specially designed see through storage container for your ROMs which protects them from mechanical and static damage when not in use. Consider the features:

- Very simple to install, no soldering or modifications to the BBC Micro are required.
- Uses a professional ZERO INSERTION FORCE SOCKET (ZIF) so no force is required changing a ROM.
- No further expense, ROMs are used as supplied without expensive specialised cartridges. The storage box included stores up to 12 ROMs in perfect safety.
- Fits neatly into the existing cartridge slot on the lefthand side of the BBC Micro keyboard.
- The low profile design of the socket gives unrestricted access to the keyboard, unlike other cartridge systems.
- Allows easy installation and changing of Sideways ROMs, all without dismantling your BBC Micro. Once locked in position in the ZIF socket the ROM behaves as a normal sideways ROM.
- No more problems of running out of socket space, simply unplug the ROM and plug a different one in!

A REAL MUST FOR PROFESSIONALS
AND HOBBYISTS ALIKE

ONLY £16

BOOKS (No VAT on Books)

30 Programs - BBC Micro	£3.25
30 Hour BASIC (BBC Micro)	£6.95
35 Education Programs for BBC	£6.95
36 Challenging Games for BBC	£5.95
40 Educational Programs for BBC	£5.95
100 Programs for BBC Micro	£6.95
Cassette version of above	£10.00
6502 Application Book	£11.95
6502 Assembly Language Program ..	£13.95
6502 Assembly Language Subroutines	£14.25
6502 Machine Code for Beginners	£5.95
6502 Software Design	£10.50
A young persons guide to BBC Basic ...	£4.50
Advanced Machine Code Technique for BBC	£7.95
Advanced User Guide for BBC Micro	£11.95
Advanced Graphics with BBC	£9.95
Advanced 6502 Interfacing	£10.95
Advanced 6502 Programming	£12.45
Assembly Language Programming on BBC Micro	£7.95
Advanced Programming Techniques for the BBC Micro	£7.95
BBC Basic	£7.95
Assembly Lang. Prog. on BBC	£7.40
BBC BASIC	£5.95
BBC Basic for Beginners	£6.95
BBC DIY Robotics & Sensors	£6.95
BBC Forth	£7.50
BBC Lisp	£7.50
BBC Micro An Expert Guide	£6.95
BBC Micro Book BASIC Sound & Graphics	£7.95
BBC Micro Graphics and Sound	£6.95
BBC Micro Programs in Basic	£5.95
BBC Micro ROM PAGING System Explained	£2.00
BBC Micro Revealed	£6.95
BBC Micro Assembly Lang. Prog.	£7.95
BBC Micro Disc Companion	£7.95
BBC Micro in Education	£6.50
Basic Programming on BBC Micro	£5.95
Best of PCW Software (BBC)	£5.95
CP/M Users Guide	£13.95
Creating Adventure Programs on BBC Micros	£6.95
Creative Graphics Cassette (Acornsoft). Has 36 graphics programs	£8.95
Creative graphics on BBC Micro	£7.50
Complete Programmer for BBC	£5.95
DISC FILING SYSTEM (DFS) Operating Manual for BBC	£6.95
Discover BBC Machine Code	£6.95
Discover FORTH	£13.95
DIY Robotics & Sensors with BBC	£6.95
Further Prog. for BBC Micro	£5.95
FORTH Programming	£14.40
Functional Forth for the BBC Micro	£5.95
Games on your BBC Micro	£2.95
Games BBC Computer Can Play	£6.95
Graphs & Charts on BBC Micro	£7.50
Graphic Art for BBC Computer	£5.95
Graphs and Charts (Cassette)	£7.50
Graphics on BBC Micro	£6.95
Hobbit (Book and Cassette)	£14.95
Introducing the BBC Micro	£5.95
Introduction to FORTH	£9.30
Intro to Micro Beginners Book (3 Ed.)	£9.90
Let your BBC teach u to program	£6.45
LISP	£9.25
Logo Programming	£8.95
Mastering VISICALC	£12.45
Mastering CP/M	£13.65
Micros in the Classroom	£4.90
Programming the 6502	£11.95
Programming & Interfacing 6502	£16.00
Programming the BBC Micro	£6.95
PASCAL	£9.25
Programming for Education on BBC ...	£5.95
Structured Prog. with BBC BASIC	£6.50
The Complete FORTH	£6.95
The BBC Micro Book, BASIC, SOUND & GRAPHICS	£7.40
Using Floppy Discs with BBC Micro	£5.95
Using BBC Basic	£6.95
Using 6502 Ass. Language	£14.50
Wordstar & CP/M made easy	£6.95

PLINTHS FOR BBC MICRO AND PRINTERS

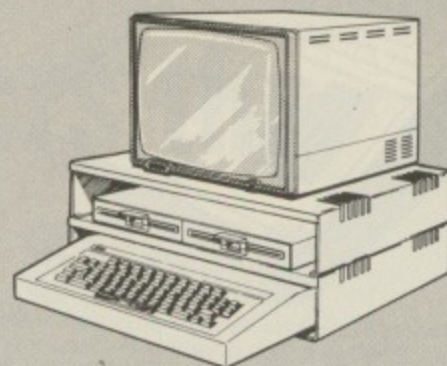

Protect your computer from the weight and heat of your monitor. BBC micro plinths have slots for maximum ventilation. Single height version is suitable for BBC and monitor. Double height version allows the disc drives to be used in the centre section or stationary, etc. The computer slides easily in to place, allowing easy access to remove the lid.

The printer plinth is equally sturdy but without the cooling slots. This allows the paper to be stacked under the plinth with the printer on top - a very convenient way to work as it does not require the usual very deep table.

SINGLE BBC PLINTH **£11** (carr. £1.50)
DOUBLE BBC PLINTH **£20** (carr. £2.00)
PRINTER PLINTH **10** (carr. £1.50)

4 WAY MAINS DISTRIBUTION SOCKET



4 way top quality mains trailing sockets. Supplied wired up with mains plug ready for use. Can be screwed to floor or wall if required. Very useful for tidying up all the mains leads from your peripherals. Allows the whole system to be switched on from one plug.

£9.50

ASSORTED CONNECTING LEADS

(All ready made and tested)

CASSETTE LEADS 7 pin DIN Plug to 5 pin DIN Plug + 1 Jack Plug	£2.00
to 3 pin DIN Plug + 1 Jack Plug	£2.00
to 7 pin DIN Plug	£2.50
to 3 Jack Plugs	£2.00
6 pin DIN to 6 pin DIN Plug (RGB)	£2.50
MONITORLEADS Microvitec RGB leads 6 pin DIN to 6 pin DIN for colourmonitors	£2.50
KAGA/SANYO Colour Monitor Leads	£5.00
Monochrome monitor leads	
BNC to Phono	£3.00
DISC DRIVE POWER LEADS Supply from BBC power supply to standard Disc Drive connector.	
Single	£3.00
Dual	£3.75

MISCELLANEOUS CONNECTORS

	Plugs	Sockets
RGB (6 PIN DIN)	30p	45p
RS423 (5 pin Domino)	40p	50p
Cassette (7 pin DIN)	25p	65p
ECONET (5 pin DIN)	20p	30p
Paddles (15 pin 'D')	110p	215p
BBC Power Plug 6 way	80p	-
Disc Drive Plug 4 way	75p	-

ATTACHE CARRYING CASE for BBC Micro

The Attache carrying case is attractively finished in mottled antique brown leatherette. The case is made of tough plywood, providing a very solid and safe way to carry your BBC micro. There is room provided to fit all the leads necessary behind the computer and manuals in the front. Locks supplied with two keys. Price **£12** (£2 carr.)

Continued

EPROM PROGRAMMER

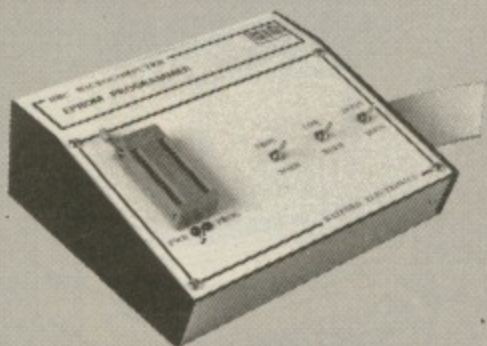

The Watford Electronics' EPROM programmer for the BBC micro is a high quality self contained package. Programs all popular EPROMs from 2K to 16K: 2716, 2516, 2532, 2564, 2764 and 27128. All manufacturers' specifications have been followed to program EPROMs at the correct speed - wrong timings could destroy your EPROMs. The unit has its own power supply so does not put heavy loads on the BBC power supply as do some other units. Connects directly to the 1MHz bus following all Acorn recommendations on addressing and bus loadings.

SOFTWARE PACKAGE

The software is supplied on an EPROM which plugs into the Micro and is instantly available with a single command (no time wasting as on Cassette/disc loading). It is a fully purpose designed and integrated package to simplify ROM development. The system is menu driven with many prompts to avoid any accidents.

Software facilities include:

Load File - Save File - Down Load EPROM - Program EPROM - Verify - Blank Check - Editing of memory contents prior to programming.

Also included is an automatic system to allow Basic programs to be put in EPROM and accessed through the *ROM filing system. More than one program may be put in an EPROM. All these facilities and more are explained in the comprehensive and clear 15 page manual.

ONLY £79 (£3 carr.)

TEX EPROM ERASERS

EPROMs need careful treatment if they are to survive their expected lifetime. Over erasure of EPROMs very rapidly turns them into ROMs! The TEX erasers operate following the manufacturers specifications to give the maximum possible working life by not erasing too fast. We use these erasers for all our own erasing work.

- **ERASER EB** - Standard version erases up to 16 chips. **£28**
- **ERASER GT** - Deluxe version erases up to 28 chips. Has automatic safety cut-off to switch off the UV lamp when opened. **£30**
- Spare UV tubes. **£9**

VOLTMACE DELTA 14 JOYSTICK SYSTEM

The Voltmace system provides full facilities for connecting the Delta 14 handset.

Delta 14 handset - On its own makes a high quality centre sprung analogue joystick with fire buttons **£12.50**

Adaptor Module allows use of two joysticks and provides hardware to access all the keys on the keypad of the joystick **£12.55**

Transfer program allows use of the keypad keys and joystick to simulate any key on the keyboard. This works by creating a machine code patch that stays in memory while another program is loaded in. Allows any game to be used with joysticks. Supplied on disc or tape.

Tape **£5.10** Disc **£7.95**

STANDARD JOYSTICKS

These are standard analogue type with a fire button on each joystick. Twin joysticks go to a single moulded plug, long leads provided.

Single Player version **£7.00**
Two Players version **£12.00**

MK 2 13 ROM SOCKET EXPANSION BOARD

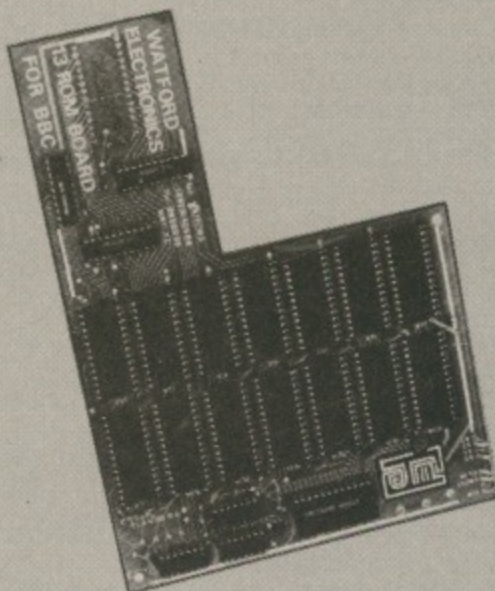

Now all lines fully buffered - On board battery back-up facility - will now accept EPROMS 2716, 2732, 2764 & 27128 and ROMs 6116 & 6264.

Simply plugs into one of the four ROM sockets currently available in BBC Micro. There are only 5 solder connections to be made. Full instructions are supplied. This board has been ergonomically designed to enable the user, easy further expansion inside the Micro, e.g. Double Density Board, Torch Board, etc. (At Watford, we think ahead.)

Our Mk2 13 ROM Socket Board enables the User to increase the sideways ROM capacity from the basic 4 sockets upto full 16 capable of being supported by current operating systems. In addition the board is designed with the facility to hold upto 16K RAM, which when switched into operation is automatically selected by any WRITE signal to the Sideways ROM area. This gives the User the ability to write a utility or language and upon pressing break have the utility or language up and running (new ROM software can be developed and tested in situ.)

The Board gives the User, plenty of freedom to explore the possibilities of the new paged ROMs due in the coming months and offers them the chance to develop their own.

All lines are fully buffered and the Board meets or exceeds all timings for operation in the BBC Microcomputer. When fully populated, the ROM Board consumes less than half the recommended maximum current limit.

Supplied ready-built and tested complete with fitting instructions.

ONLY £32.50 (carr. £1)

THE INVESTIGATOR

A utility program provided on disc to make security backup copies of all your valuable discs. Makes full use of all 8271 facilities to discover the precise format of your protected disc so that an exact copy can be produced. Supplied with detailed instructions. Please specify 40 or 80 track disc when ordering. **Price £25**

LIGHT PEN

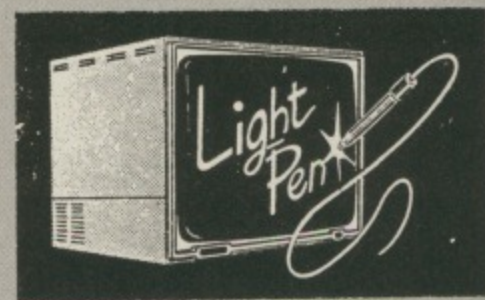

This Light Pen for the BBC micro is packaged in a neat pen shape with built in switch. Supplied complete with our sophisticated Pen-Pal software on cassette (see elsewhere in this ad).

Only £20

(For software on disc please add £2)

DATA RECORDER AND ACCESSORIES

Top quality slimline portable cassette recorder designed specifically for use with home computers. Mains/Battery operated with tape counter.

£20

DATA CABLE to connect recorder to BBC

£2.50

DATA CASSETTES - Top grade tested C12 Data cassettes supplied in library cases **35p**

MISCELLANEOUS

28 pin DIL PLUG

£1.85

Solder type

£2.90

IDC Crimp type

£7.50

28 pin ZIF SOCKET (Textool)

£0.60/foot

34 way Ribbon Cable

£0.87

8 way DIP SWITCH

ANTI GLARE MONITOR SAFETY SCREEN



HEADACHES? TIRED EYES? Don't take pills - Use a Watford Electronics anti-glare filter!

Considerable research into the possible health problems associated with monitor screens has shown that eye strain, blurred vision, watering, itching eyes and headaches can result after prolonged use. The problems are caused by extraneous reflections which force the eye to continuously re-focus to try to ignore them. The answer is our contrast enhancement, anti-glare filter which is similar to those which have been previously available on business systems, but at the low cost that you would expect for your personal computer. You will soon find the reduction in eye strain well worth your investment.

Features:

- Simple fitting with sticky Velcro pads.
 - Easily removed for cleaning.
 - Tinting improves colour quality and contrast.
 - Works on monochrome or colour monitors.
 - Curved instead of usual flat screen reduces edge distortion.
 - Made in Britain by a long established glass maker.
- Available in 9", 12" and 14" versions - please specify when ordering.

Introductory offer price: **£14.95 (carr. £1)**

Prices subject to change without notice and available on request.

MAIL ORDER AND RETAIL SHOP. TRADE AND EXPORT INQUIRIES WELCOME. GOVERNMENT AND EDUCATIONAL ESTABLISHMENTS OFFICIAL ORDERS ACCEPTED. CARRIAGE: Unless stated otherwise, please add 75p to all cash orders.

VAT: UK customers please add 15% VAT to the total cost incl. Carriage.

SHOP HOURS: 9.00am to 6.00pm. Monday to Saturday. (Ample Free Car Parking Spaces)
ACCESS ORDERS: Simply phone: Watford (0923) 50234. (24 Hours)

 **Watford Electronics**

Dept. BBC, 250 HIGH STREET, WATFORD, ENGLAND.
Telephone: 0923 40588/37774. Telex: 8956095

Strategy enters the shoot-em-up scene

TRYING to review *Elite* (Acornsoft) is rather like trying to re-write the BBC's manual to fit on a postage stamp. This is the first Acornsoft megagame and let's hope that there are more to come.

It is based around *Traveller*, a role playing game first developed some eight years ago.

You are a space ship commander trying to make an impact on the world of intergalactic trade. You begin with a very basically equipped space ship of the Cobra MkIII combat and trading type, containing a single forward laser and three missiles.

You have 100 credits with which to buy your cargo and now you start your first mission. Against you are several different types of enemy craft among the 16 or so types that ply the same routes as you.

Most of the other craft are far more manoeuvrable and powerful than your ship and this can give you a great many problems in the early stages.

As you accumulate your fortune you can customise your vessel to maximise your chances of survival – extra computers, lasers, space scoops, power supplies and even a large cargo bay on offer besides the fuel, missiles and energy bombs.

The price of these items vary from 30 to 6000 units, but you can only buy certain items on certain planets.

There are more than 250 planets in each of the eight galaxies so there is plenty of scope for exploration and profit.

One criticism that should be made is that there is no scope for alliances, which could have made the whole game much more interesting.

Not that the game lacks in

interest – it is the type that keeps you up at night and leaves you feeling somewhat drained the day afterwards.

The graphics are one of its major features and can only be described as spectacular. The program gives the impression that there are two screen modes, in windows, at one and the same time.

The top of the screen is the view from the window of the craft while the lower part gives an instrument panel reading. The most interesting feature on the panel is the three dimensional radar screen showing both the location and relative height of all raiders in the vicinity.

This usually means trouble,

and an empty screen means a happy life.

There are a number of other screens in the program – short range scan, galactic scans, status, market prices and planetary information – in all a vast array of data which can be very hard to take in on the first few occasions.

The package contains a 64 page training manual, a quick reference card, a 48 page novella, a function keystrip, a spaceship recognition poster, loading instructions and a competition entry card.

This is not a game for the dyslexic! It is not over priced and should keep the kids quiet for many many eons.

Dave Carlos

Answer to that 'if only' question

HAVE you ever heard a teacher saying about your child: "If only he would learn to concentrate"? If you have, then *Hide and Seek* is the program for you.

Like all tapes from Applied Systems Knowledge loading is simple, reliable and quite fool-proof. The child has a choice of three related but different activities, the first being Find It.

In this game, six pictures appear one at a time at the bottom of a screen. They are then automatically transferred into one of the six boxes forming a block in the main part of the screen.

When all the boxes have been filled and the child has therefore seen some objects for a considerable number of seconds, delightful candystripe blinds roll down over each box, with appropriate sound effects.

When all are covered, and the child has pressed the space bar, a clone of one of the six objects is

drawn below the block and the child has to decide which box contains its twin.

This is simply done by pressing the space bar to move the black marker around the boxes. Pressing Return removes the blind and the child finds whether or not he had chosen correctly.

If the pictures do match, that blind remains open, and the process is repeated. An incorrect choice is once again covered up and the child has one further option to choose correctly before the correct box is revealed.

Our younger children spent a long time on this program, but when they felt more secure they moved on to *Seek It*.

This is similar, but there are further options in the program which determine how long the child sees each picture in its box, and whether the shutters closed all together or individually.

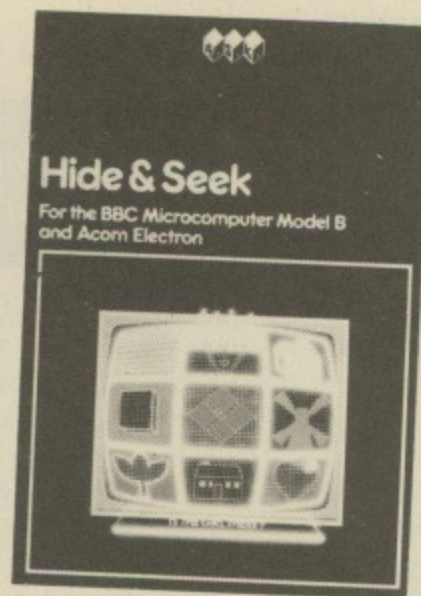

Eventually some hardy souls will try their hands at the final choice, *What's Missing?* This allows the student to brush up either reading or spelling.

Both games are similar, but in one the child has to decide which word appearing on screen tallies with the object mysteriously removed from the set of six.

The other game requires the child to select the correct name and then spell it correctly.

Two added bonuses – the cassette is compatible with the BBC and the Electron, and for disc owners, there is at least a disc copy available.

Phil Taylor

Ideal for the well armed student

BIOLOGY is a suite of 21 short programs by B.G. Mainwaring for use with CSE 'O' and 'A' level students.

There is very little given in the way of documentation, merely two sides of a small card giving program names, loading times and brief descriptions.

Details are also given on how to run them on a BBC Micro that has an active disc filing system and also how to save the programs on disc if desired.

Most of the programs are introduced with audible as well as visual cues. In principle this is a good idea, but the thought of the sound of several micros running these programs at the same time is horrendous.

After a somewhat irritating introductory sound sequence,

From Page 47

program one produces a nice colour display of the human skeleton. A series of 10 questions asking for correct labelling of bones follows.

Program two demonstrates levers in the body and others cover the female mammalian reproductive system and menstrual cycle, mendelian genetics, genotypes, biochemistry, the central nervous system, the mammalian ear, blood circulation and the mammalian eye structure and function.

Clearly you get what you pay for and at £12.50 each program costs only 60p. Not bad!

For those teachers who have some ability to program it would be desirable to add more features to this package in order to enable it to be clearer and less student prone.

Biology from Silverland has a lot going for it. It would be best used by individual students who were well-armed with notes, rather than for class demonstration and would be of most use if stored on disc to enable rapid access.

Peter Hillman

Watch out for the red haircuts!

IN **Screwball** from MRM you have 60 seconds to change the colours of every square in the complex grid that surrounds you simply by jumping on them.

Pestering you all the time though are four evil black bugs – with terrific red haircuts!

As you progress through the levels they become increasingly harder to avoid, so to get rid of them you can dig holes for them to fall into.

If they do fall in you receive a large bonus but they sometimes cheat and jump over squares.

If they catch you, you lose a life. But if you're really in a mess you can hyperspace to the top of the grid although you won't always survive this journey.

The screen layout is good. Your score, level, lives and time left are all displayed. The graphics resemble those of Q-Bert. Sound effects are excel-

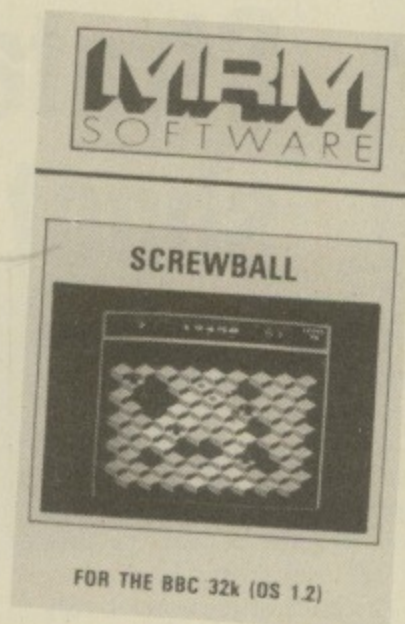

lent, adding to the fun.

It has all the usual features. There's a high score sheet, sound on/off and a freeze-game facility.

The selected keys make control smooth but, unfortunately, no joystick can be used. It's a one player game but as there's nothing complex to learn, it is popular with all the family.

I found it most addictive. **Screwball** is fun, fast and good value for money.

Simon Rubins

Fine, when The is sorted out

SPELLCHECK from Beebug-soft is a spelling checker utility available on disc in two versions – as a companion to either Wordwise or View word processors. The Wordwise version is described here.

The package contained two single sided discs – a program disc and a dictionary disc – and a 12 page instruction booklet.

Following an auto-boot, the system is menu driven throughout and basically involves the choice of drives, loading of a text (Wordwise) file and selection of the spelling check option.

The textfile is then compared word for word – punctuation, numerics and embedded commands are ignored – against the supplied dictionary of around 6,500 words.

The base dictionary has a wide range of general usage words with varied endings and a

QUICK RUNS

A first look at some of the latest releases

Drumkit: Let your Micro provide a rhythm accompaniment to your music using this fully programmable synthesiser. Samba, cha cha, rumba or rock – you name it, you can create it, using an on screen menu to control four drums and percussion instruments. You can store up to 4,000 beats and save the results for later use. (Quicksilva).

★★★

Graph-Easy: This package demonstrates the benefits of using graphs whether for CSE problem solving or as an aid to management decision making. Plots up to 30 points, connects, calculates lines of best fit, draws complex curves, differentiates, integrates and allows two curves on-screen at the same time. (Hama Systems).

★★★

Space Station Alpha: The deadly Cylon fleet is out to destroy Earth with its devastating lithium torpedoes. Earth's shields are gradually being drained as you try to wipe out the enemy before it

destroys the planet. (Icon).

★★★

Zorakk the Conqueror: Journey through medieval lands in search of the long lost Crown of Ultimate Darkness. Battle with brigands, and suffer plagues and famine in your quest. Take the part of Zorakk and control your warriors in this graphic adventure.

★★★

Serpents Lair: A text and graphic geological adventure game for all the family designed to educate and entertain. Your task is to aid the Wizard in tracing the King's jewels. Fly your magic carpet around the world and meet a variety of animals and characters in your quest. (Comsoft).

★★★

Gatecrasher: This strategy game is designed to test your mind to its limits. Drop barrels down the chute of your choice to deposit them in a series of empty boxes at the bottom of the screen. Between entry and exit points the

barrels roll through a maze of tunnels, the direction of flow dependent on moving gates. (Quicksilva).

★★★

Home Accounts/Mail Order Control: Designed for the average household with the normal compliment of bills paid by cheque, cash or standing order. It incorporates facilities for 25 standing orders, 150 bank or customer accounts and many others. (BJ Software).

★★★

Test Match: Text only simulation capable of playing any type of match from 20 overs to a full five test series. You choose the type of match, the teams, the bowlers and set the field. The computer takes over and plays the match ball by ball, indicating wides, no balls, maidens, owzats, and changing weather conditions. (Quasar Education).

★★★

Smash and Grab: As the robber you must collect gold falling from the bank

modicum of computer associated words, such as algorithm, BBC, binary, micro, processor and program.

Spelling is English not American, which should be a relief to CP/M software users, and includes some useful slang or abbreviations such as pub, Ltd, eg, ie, phone, telly, mummy and tummy!

When a textfile has been loaded and the spelling check option selected, the user is prompted for an automatic check or an attended check.

In the automatic mode, Spellcheck scans through the text marking unrecognised words. Though checking words against the dictionary is amazingly fast, it can be quite tedious to watch it scan a long document and a coincidental coffee break is recommended.

An average page of 300 words is checked in about two and a half minutes if all the words are also present on the dictionary disc, and about five and a half minutes if none of the words are recognised.

Obviously most normal text checks will be somewhere between the two.

Though it is somewhat

tedious to use it is reasonably thorough and I will wholeheartedly recommend it when its one major deficiency is rectified – it cannot detect 'THE' and similar mistypings as incorrect.

This feature is available in some other spelling checkers and I'm sure could be implemented here. However, I do hear that there are some small program improvements and a more useful base dictionary on the way.

Mike Mahon

Simply magic . . .

ALL is peaceful in the garden. Mr. Wiz is going about his daily business of harvesting the cherries when suddenly, from behind the toadstool, a hideous beastie appears.

Will Mr. Wiz out-run the monster? Will this year's cherry harvest be affected? Will our hero be caught by the gremlins?

Only you can answer these questions as you play this exciting and colourful variation on the Mr. Do theme from Superior Software.

As Mr. Wiz you must

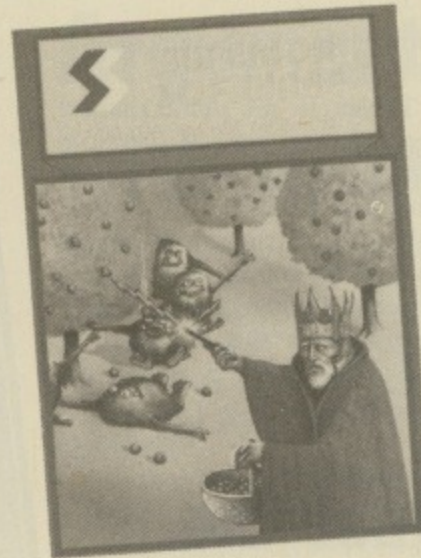

negotiate your way around the garden in an attempt to collect all the cherries. As you move through the long grass you leave a clear path behind.

The gremlins, which appear at regular intervals from the central toadstool, will normally only travel along these clear pathways. Your only weapon is a trusty crystal ball.

To use this you must turn and face a pursuing gremlin and hit the space bar. This sends the crystal ball zig zagging along the pathway killing the blue meanie.

I would recommend that the crystal ball be used in emergen-

cies only as it takes quite a spell to recharge.

Scattered around the garden are several large apples. By clearing away the grass directly below these you can cause them to fall vertically until they reach the next area of long grass. As your confidence increases you may like to try enticing several gremlins to follow you.

You then create a long path vertically upwards to the base of an apple and at the last moment casually side step it as it falls on the gremlin hoards.

Should you be feeling really adventurous – although suicidal may be more accurate – you can then devour the central toadstool and collect a bonus of 1,000 points.

All of this action is performed to the strains of Orpheus in the Underworld – Can Can to you and me – which unfortunately cannot be turned off.

Another oversight is the lack of a pause game feature. These two facilities are normally expected as standard on BBC games of this quality.

However, these two omissions aside, I can honestly say that this game is magic.

Jon Revis

window. Your opponent naturally is a policeman who tries to knock you into the water. Watch out for the flying cones and dustbin lids. Kick the flashing police box and give the bobby a ducking instead. (Superior).

★ ★ ★

Wallaby: Vicious monkeys have stolen your baby Wallaby and hold it captive in a cage at the top of a tree. Using ladders and platforms you must get to your kin, boxing the enemy, which as well as trying to catch you, hurls apples at you continuously. Leap for the fruit for bonus points. (Superior).

★ ★ ★

Paranoid Pete: A world wheat shortage has sent Pete the space farmer to the surface of the planet Owayondah. There, by digging holes he must plant the seeds as they fall from the ship. He must fend off the Megawibbles who are intent on greedy destruction. Successful growth on the planet leads to processing in the ship with yet more pain from the

meanies as they materialise on board. (Ubik).

★ ★ ★

Missile Strike: Defend your cities by correctly positioning your laser sight and fighting off wave after wave of tumbling missiles. You control the laser from a central base and score bonus points for cities left standing and unused bolts. (Superior)

★ ★ ★

Chess: A computerised simulation of the classic board game. Pre-game options include set level, play, replay, save and load game, and problem solving. Additional options available at your move include take back, resign, modify the board, display of best move, change level and change colours. (Superior)

★ ★ ★

Mutant Spiders: Within a preset time limit you must rid the colonies of swarms of vicious three legged mutant spiders. Your only weapon is a laser cannon as you attempt to earn bonus

time points by destroying them before they destroy you. (Superior)

★ ★ ★

Football Pools: This utility calculates the probability of any match being a home win, draw, or an away win. It lists in order of preference the best 16 score draws, homes, aways and draws and picks out those which have been given over-generous odds on the fixed odds coupon. (Hartland).

★ ★ ★

Bouncing Bill: Get Bill from the bottom of the screen to the basket of damsons at the top by jumping up onto walls through randomly moving gaps. Misjudge a gap and Bill hits his head and lies stunned for a while. You only lose a life if you fall through all the walls to the bottom, or you're caught by ghosts which increase in number on each successful screen. If you can catch a floating balloon you score bonus points. (Oak)

Waste of valuable micro time

THERE are many valid, exciting and original ways of using the valuable time of the school BBC Micro – unfortunately **Mental Arithmetic Tests** from Small Schools Software isn't one of them.

It isn't just that a formal and rather boring subject should be chosen, but unfortunately the screen display, programming and general educational value are poor.

There are three programs, all largely written in Mode 7, but including none of the colourful graphics which that mode can support.

The individual test allows one of many topic and difficulty levels to be decided, after which a number of questions are printed on the screen.

They are identical to the formal maths books which most teachers now use with great care and suspicion, but add nothing to that format.

The programming is also a little suspect, for one is asked such undesirable questions as "What is the sum of £0.75 and £4.6?"

Even worse is the suggestion to use the class test on a screen in front of a whole class. I found myself wondering whether the

author had ever faced a class of 35 children.

Tables is an unimaginative question-and-answer session, concentrating on one particular table at a time.

No, if a teacher at my school tied up a computer for such a trivial and unimaginative suite of programs as this I would be sorely disappointed, to say the very least.

Phil Tayler

Just the right blend . . .

NUMBER Chaser by Applied Systems Knowledge has long been available on tape for the BBC Micro and it has deservedly gained great popularity in many schools.

This new version is for both the BBC and the Electron on tape and disc.

The program asks the child to decide which of four vehicles he will drive in the race. The easiest is a cycle, with an extremely hard level being set if the racing car is selected.

The idea is that the child controls the movements of one car while the computer drives a similar vehicle. A four lane raceway is drawn and a multiplication question appears at the top of the screen.

Below, one above each lane,

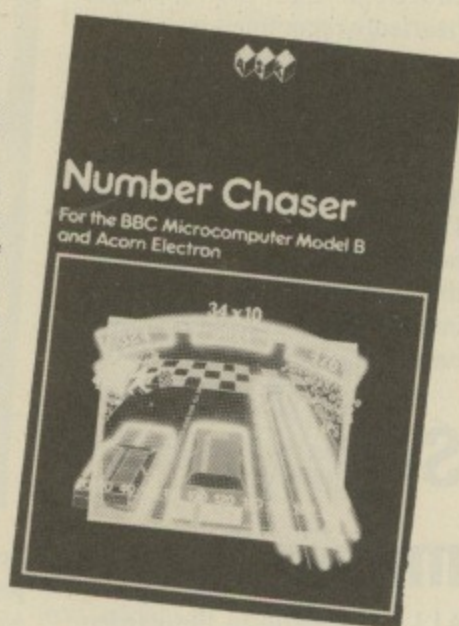

are four answers. None is correct, but the child has to decide which is the closest.

The Z and X keys are used to move the car into the correct lane, and the micro car also follows into that track. If the answer is correct the child's car inches ahead of the other, another question appears, and the race continues.

When a wrong decision is made, the correct answer is shown while the screen freezes and the child's car moves back closer to the computer's car.

Too many wrong answers produce a crash while eventual success brings about a rather nice victory celebration.

The program has the right blend of enjoyment and educational purpose. I thoroughly recommend it.

Phil Tayler

Solving an age old problem

FOR years music teachers and parents have tried, by a variety of devious means, to get young instrumental players to regard practice as enjoyable.

Words like *joy*, *pleasure* and *fun* are used in the titles of many teaching methods, but they don't fool anyone.

Practise and Play from Special Business Software provides an interesting and exciting answer. The package is for the young player who can play an octave or so.

The program is designed to teach six pieces of music chosen from the top of the pop market.

It is accompanied by an instrumental part book and an audio cassette of pre-recorded accompaniments for each of the pieces.

The notation of each tune is displayed with or without a bouncing ball as the pitch of each note is sounded. The whole thing can be slowed down to suit the player and can be made to appear in short sections.

As little as one bar of music can be repeated indefinitely at varying speeds – an ideal way of getting to grips with the difficult bits!

The thing that provides the motivation for all this hard work

Save your planet – it's worth it!

IN **Renegade Robots** from Senator Software, you play a scientist trying to save his planet from deadly robots which have gone out of control.

To protect the laboratory you must re-align the three key control cubes. In order to do this you are able to slide the cubes by pushing them in the required direction.

The cubes will disintegrate if pushed against another cube or a border, but the key cubes cannot be destroyed.

The robots can be knocked out by squashing them against the cubes.

As the robots home in on you they can completely destroy the



cubes – except for the key cubes – which are coloured differently from the rest. You are able to

pick up a large bonus and an extra man if you can place the key cubes in a special way.

There are two timers in the game, one a preview timer and the other a bonus timer.

The preview timer allows you to work out your moves at the beginning of each screen, a nice touch which comes in very handy.

If the bonus timer reaches zero, then you move onto the next screen.

Each screen appears the same except that the cubes are placed in different positions and there are more robots which move faster.

The control is nice and

smooth with keys or joystick and the graphics are good.

There are three levels of skill and I feel that with practice, players would soon progress to the third level, which is difficult but still enjoyable.

There are nice sound effects but the signature tune played before and after a game becomes a little tedious at times.

However you can turn the sound off at any time and there is also a pause-game facility.

Overall the originality and good graphics of **Renegade Robots** make it extremely addictive and well worth the money.

Simon Rubins

and diligence are the pre-recorded accompaniments.

Without them, this would be just another method. But the two complement each other so well that mistakes in the difficult bits make you dive back into the program until you get it right.

The tape is worth listening to on its own. In the main it consists of synthesised sounds, with one or two "real" sounds added for fun.

The honky tonk piano style of "This Ole House", the humorous bird imitations of the "Birdie Song", the steel band in "Brown Girl in the Ring", plus "House of the Rising Sun", "Amazing Grace" and "Can Can", all add to the fun but never lose sight of what it's all about — more practice and better playing.

In general, this is colourful music well presented, providing a lot of motivation and encouraging good listening habits for ensemble playing.

Instructions are always clear and easy to follow and the degree of user control makes it a joy to use.

Bill Noble

Playing shop brought up to date

BARCODES are very much a part of our world now. All items on supermarket shelves carry one. And when I rush to the library for information I am greeted with an assistant with a light pen reading these black and white stripes in the books.

Yet there are many of us with very little idea of what barcodes actually do.

One advantage for the shop is the relaying of the messages to a main computer, which will in turn organise the automatic restocking of shelves.

Beebshop is an attempt to demonstrate these ideas in the classroom, thus updating the "shop" found in many primary rooms. This project is aimed at a wider age range.

Although the printed notes suggest a lower-secondary

group, I tried it out with my top juniors, and met with some success.

I have tried to avoid using the word program as the package — from Alpha Computer School — actually contains a program either on cassette or disc, teachers' notes and worksheets, and a small module which plugs into the AD converter.

In addition there are some acetate sheets with which you can make your own barcodes using the very clear and detailed instructions. The whole package is priced at £25, with further readers available at £18.

However the real test is how it performs in the classroom, and I have to report mixed results. When I first set it up I tried out the two barcodes which the company had thoughtfully provided for my review.

To the great delight of the children, the corned beef and the cod in mushroom sauce managed to be read as cats supermeat, vinegar and prime back bacon smoked!

Eventually it became obvious that the speed of movement through the reader was fairly critical, and I soon became adept at producing faulty bills.

However the children met no such difficulty and so I had to bow to their superior youth.

Making the barcodes was easy, and quite a selection can be made simply and quickly. The software loaded with no problems. It allows each item passing through the reader to be displayed on screen. On pressing Esc a total cost is displayed.

A couple of months ago I used the BBC Buggy, which includes a program on barcodes, but I must confess that this one is a superior idea, having much more flexibility.

Phil Tayler

Useful...but quite limited

DESPITE its impressive title, **BBtype**, from Furey Enterprise, is a somewhat primitive word processor program. Its only major feature is the ability to load in predefined character sets such as accents of foreign languages and technical and scientific symbols.

This can prove quite useful for students preparing their work or

Arguments settled with armed combat

THE sun blazes down on the secluded valley as the knights draw their swords and prepare for combat. That's the setting of **Swordmaster**, a new and highly original two player game from Micrograf.

Full instructions are loaded in with the first part of the game, as the BBC Micro plays as stirring rendition of Elgar's Enigma Variations.

The instructions tell of an order of mediaeval knights, the Teutronics, whose members occasionally settled their differences by combat in a secluded valley.

There were strict rules which the knights had to follow, some of which seem a bit severe. For instance you had to be male and over 14, which will no doubt cause a stir among feminists.

When the main game loads you are asked to choose between keys or joystick and then type in your names. The choice of keys is convenient as those for each player are at opposite ends of the keyboard.

These control your directional movement and your sword arm.

Once you have completed the formalities the battle commences.

The most exciting part of the game is pursuing your enemy and forcing him to fight. When you corner him the action is fast and furious as limbs are slashed and blows exchanged.

The sound is effective and the clang of the swords is particularly notable. But I think the most impressive feature is the super smooth graphics and the

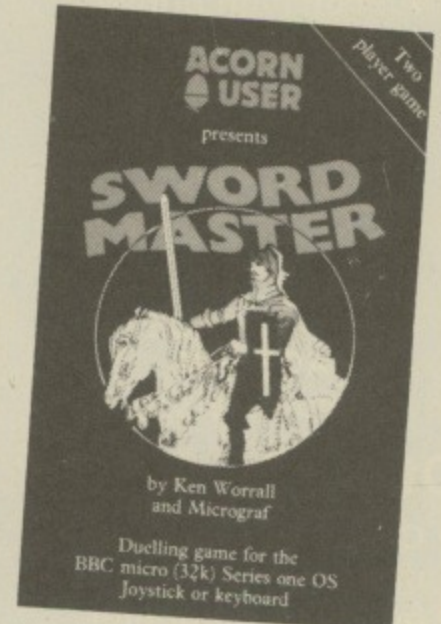

delightful animation. The motion of the arms and legs are among the best graphics I have seen on the BBC Micro.

You can progress through the rankings from greenhorn to Swordmaster, and also included is the ability to save your player onto tape.

I found myself playing game after game with my brother, and my best warrior got to be a novice before he met his end.

The game has a certain addictive quality and the only quibble I have is the lack of a one player game facility as I found myself with no opponents as soon as my brother departed.

The unvarying screen display could become annoying in the long run. But apart from this, **Swordmaster** is a highly entertaining and original game with excellent graphics and will appeal to a wide variety of gamers. Highly recommended.

Mark Wells

for business letters where you may wish to impress a foreign client with your deep knowledge of the client's written language. But there are some limitations to the **BBtype** package.

For a start it needs the Acorn DFS — it certainly did not want to know about the Watford DFS 1.3 when I tried it. It also requires an Epson printer from

the MX, RX or FX range using the parallel interface only.

The printer needs to be switched on when using **BBtype**, whether you intend to print or not, which is a little bit silly.

A simple menu requesting the character set you wish to work with starts the program. There

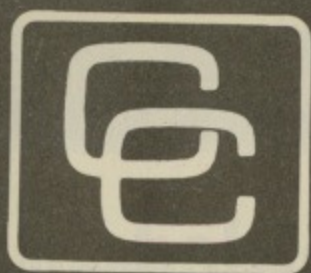

Computer Concepts

General:

All common printer facilities are made available with easy-to-use commands including:

- * UNDERLINE
- * ITALICS
- * STYLE
- * LINE SPACE
- * PAGELEN

.... and others

Other Facilities:

- Character definition utility.
- Send files to printer at the same time as running BASIC programs etc.
- Interactive window setup, for choosing area of screen to be dumped.
- Save/load character font.
- Large character printing.
- Commands can be included in wordwise text (version 1.2 onward)



Computer
Concepts

Gaddesden Place
Hemel Hempstead
Herts HP2 6EX
(0442) 63933

Now available:
PRINTMASTER
(EPSON)
PRINTMASTER
(STAR)
price £33.35 incl.

From Page 51

are currently five available, defined as French/Italian, German/Scandinavian, Spanish, Mathematics and Technical.

This leads on to another little menu which you use to set up the printer to print with or without vertical spacing between lines. This is to allow formulae containing maths symbols such as large braces to extend over two lines without an unseemly gap in the middle.

Editing capabilities can be best described as barely adequate. The whole document size is limited to 80 characters by 66 lines, and it is not possible to properly load in documents from other word processors such as View or Wordwise.

This is due to the fact that BBtype stores the document as a rather wasteful 80 by 66 byte matrix instead of using carriage return to delimit separate lines like most word processors.

There is no variable margination or centering and the lines scroll 10 lines at a time, which is something I found quite a strain to use after the smooth scrolling of View or Wordwise.

Using the function keys and the templates to access the pre-defined character set is relatively simple and quite effective. The edit area is 80

columns by 20 of white text on black using Mode 3.

It is not possible to use bits of two separate character sets in a single document, but each character set has up to 40 different symbols, which is quite enough for most purposes.

Most of the editing features are accessed via the combination of the Control, Shift and cursor keys in various permutations, and another template is also supplied for reference.

Maths users may be interested to know that it is not possible to create superscripts for little symbols such as the square and cube of a number.

There are some unusual features in BBtype in that pressing Break does not seem to harm the document, and with certain limitations, it is even possible to exit from BBtype into Basic to perform calculations and return back into the program.

The print quality produced is quite good, though all the printing seems to be done in graphics mode only, which can make document printing very slow.

In conclusion, for those really desperate for the special character sets it may be worth suffering through the editor to produce your documents.

Chris Chan

Childhood wonders revealed

FOR all those who spent hours of childhood gazing down into the depths of some watery pool, wondering what was going on beneath the dark canopy of lillies and bind weed, all is now revealed.

Savage Pond, the latest release from Starcade, centres around the life of a small, helpless tadpole as it tries to survive to adulthood among the many sinister perils of the deep.

This fast moving arcade type game is set in a cross sectional representation of a typical country pond – with one or two unexpected additions.

The idea is to guide your tadpole through life, fattening it up until it develops into a fully grown adult, and then to build up a colony of thriving frogs.

You control the tadpole by using joystick or keyboard – the standard Snapper keys with the addition of the space bar and Shift.

The controls give great manoeuvrability, and you need every bit of it as you dodge

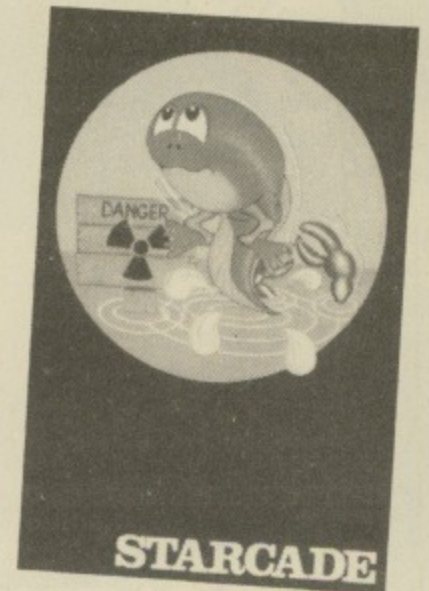

about the waving tentacles of the deadly hydra, chase after the nutritious worms and fatten yourself on the plump amoeba.

As you progress the waters become ever more hazardous with the addition of jellyfish, radio-active waste and rampaging dragonfly nymphs.

Should you survive all these you gain your first frog – a truly magnificent sight as he sits proudly on his log, lashing out his sticky tongue at the unsuspecting dragonflies above. Despite any feeling of success you might now be having, the game is far from over.

The graphics are quite spec-

The Micro User Index of software reviews

3 Deep Space (Postern) Feb 1984
 3D Bomb Alley (Software Invasion) Jan 1984
 Action of the Heart (Garland) Sep 1983
 Aid (Lincoln) Jan 1984
 Alien Destroyers (Program Power) Aug 1983
 Alphabeta (H & H) Mar 1983
 Angle (Chalksoft) June 1984
 Animal/Vegetable/Mineral
 (Bourne Educational) Oct 1983
 Answer Back (Kosmos) July 1984
 Apollo (Software Invasion) May 1983
 Arcadians (Acornsoft) Aug 1983
 Atlantis (IJK) Mar 1983
 Aviator (Acornsoft) June 1984
 Beebcalc (Gemini) Sep 1983
 Beebsynth (Claires) Nov 1983
 Beta Base (Clare) Sep 1984
 Billiards (H & H) Mar 1983
 Boris in the Underworld
 (Superior Software) Oct 1984
 Bridge to the East (Ixion) Mar 1984
 Bun Fun (Squirrel) Aug 1983
 Business Games (Acornsoft) Mar 1984
 Canyon (BBC Soft) Oct 1983
 Cashbook (Gemini) Aug 1983
 Cash Book/Final Accounts (Gemini) Oct 1984
 Castaway (Simonsoft) Oct 1984
 Castle Assault (MRM) Sep 1984
 Castle of Riddles (Acornsoft) Jan 1984
 Chess (Bug Byte) Apr 1983
 Chess (Acornsoft) Dec 1983
 Chess (Computer Concepts) Dec 1983
 Chickaroo (Screenplay) May 1984
 Circus (Digital Fantasia) Jan 1984
 Colossal Cave (Level 9) Feb 1984
 Commercial Accounts (Gemini) Jun 1983
 Community (Ixion) Mar 1984
 Connect 4 (Database) Apr 1983
 Cosmic Kidnap (Superior Software) June 1984
 Countdown to Doom (Acornsoft) Jun 1983
 County (SM) (Bryants) Mar 1984
 Cylon Attack (A & F Software) Feb 1984
 Dambusters (Alligata) Oct 1984
 Databox (Optima) Jan 1984
 Dbasebeeb (Carrera) June 1984
 Delivery (Paeon Systems) Apr 1984
 Devil's Causeway (Kaydee) Sep 1983

DFS (Amcom) Sep 1983
 DFS (Watford) Sep 1983
 DFS (Amcom) Oct 1983
 Digger (Visions) Oct 1984
 Disc Executor (Vision Software) Jan 1984
 Dragon Rider (Salamander) Oct 1983
 Eagle's Wing (Software Invasion) Oct 1984
 Easy Crasher (Salamander) May 1984
 ECFG (Gaelsett) May 1983
 Escape from Moonbase Alpha
 (Program Power) Apr 1984
 Escape from Orion (Hopesoft) Nov 1983
 Essential French Verbs (Carsondale) Dec 1983
 Eye (Langman) Aug 1984
 Facemaker (Ask) Jan 1984
 Fall of Rome (ASP) Oct 1984
 Firehawks (Postern) Dec 1983
 Five spheres of Goliath (Kansas) Sep 1984
 Fletchers Castle (Fernleaf) Oct 1984
 Flints Gold (Micrograf) Aug 1984
 Forth (Level 9) Nov 1983
 Fortress (Amcom) June 1984
 Frak (Aardvark) Oct 1984
 Franklin's Tomb (Salamander) May 1984
 Frogger (A & F Software) Mar 1983
 Fruity Freddy (Softspot) July 1984
 Fungames (BBC Soft) Apr 1983
 Fun to Learn (Shard's Software) May 1984
 Galactic Firebird (Kansas) Nov 1983
 German Sentence Practice
 (Educated Owl) Dec 1983
 Ghoulis (Program Power) May 1984
 Grafkey (Claires Soft) Apr 1983
 Great Britain Ltd (Simon Hessel) Jun 1983
 Gunsmoke (Software Invasion) Nov 1983
 Heist (Softspot) Aug 1984
 Hide & Seek (Ask) Jan 1984
 Hobbit (Melbourne House) June 1984
 Home/Business Pack (Gemini) June 1984
 Home Finance (BBC Soft) May 1983

Hopper (Acornsoft) Sep 1983
 Horror Castle (A & F Software) May 1984
 Hunchback (Superior Software) May 1984
 Hyperdrive (IJK) Mar 1983
 Inheritance (Simon Hessel) Jun 1983
 Invaders (IJK) Mar 1983
 Invaders (Software Invasion) May 1983
 Jigsaw (ega beva) May 1984
 Junior Maths Pack (Program Power) Oct 1983
 Key Definer/Char Gen (Gsoft) Sep 1984
 Lemming Syndrome (Dynabyte) June 1984
 Let's Count (Ask) Jan 1984
 Lift off with numbers (Shiva) Aug 1984
 Lines and Angles (4mat) Aug 1984
 Love and Marriage
 (Acornsoft/Ivanberg Software) May 1984
 Lords of Time (Level 9) May 1984
 Lost in Space (Salamander) July 1984
 Machine Code Tutor
 (New Generation) Oct 1984
 Man (Chalksoft) June 1984
 Markist (Optima Software) Apr 1984
 Mary Rose (Ginn) Jan 1984
 Missile Base (Acornsoft) Apr 1984
 Multibase (G Soft) Oct 1984
 Music (BBC Software) Apr 1983
 Music Editor (System) Dec 1983
 Music Synthesiser (Bug Byte) Jul 1983
 Music Tutor (Garland) Oct 1984
 Number Puzzler (Ask) Jan 1984
 Oblivion (Bug-Byte) Apr 1984
 Old Father Time (Bug Byte) Jan 1984
 One Disc Home Office (Dr. Soft) July 1984
 Omega Probe (Optima Software) May 1984
 Package 004 (Software Invasion) Jun 1983
 Paintbox (Dakleaf) Mar 1984
 Painter (A & F Software) May 1983
 Pascal, Sequences, Puncman
 (Chalksoft) Nov 1983

Peeko-Computer (Acornsoft) Feb 1984
 Pengo (H Soft) Feb 1984
 Philosopher's Quest (Acornsoft) Jan 1984
 Physics (Program Power) Dec 1983
 Physiological Simulation (Fiveways) Dec 1983
 Pimania (Automata) Mar 1984
 Printer Monitor (Watford) Mar 1984
 Programs 1 (BBC Soft) Apr 1983
 Reading Music (Childsplay) June 1984
 Rocket Raid (Acornsoft) Jul 1983
 Rubble Trouble (Micropower) Sep 1984
 Screen Dump (DACC) Mar 1984
 Sea Lord (Bug-Byte) Apr 1984
 Shrinking Professor (A & F Software) Apr 1984
 Slick (BP Educational) Jul 1983
 Snapper (Acornsoft) Dec 1983
 Snooker (Acornsoft) Oct 1983
 Snowball (Level 9) Feb 1984
 Space Pirates (Bug Byte) Mar 1983
 Sphinx Adventure (Acornsoft) Jan 1984
 Spooks and Spiders (Software Inv) Sep 1984
 Spreadsheet (Micro) Nov 1983
 Sprite-Gun (DACC) Dec 1983
 Sprites 2 (Simonsoft) Sep 1984
 Spy (System) Nov 1983
 Star Maze II (Kaydee) Oct 1983
 Starship Command (Acornsoft) Oct 1983
 Stock Car (Micropower) Sep 1984
 Superfruit (Simonsoft) Aug 1984
 Supergolf (Squirrel) Mar 1984
 Swoop (Program Power) Sep 1983
 Taxcalc (BBC Soft) Nov 1983
 Tense French (Sulis) Sep 1984
 Tess (H & H) Apr 1983
 Text Editor (G Soft) Oct 1984
 The Grange (Dobsoft) Jan 1984
 The Synth (Musicsoft) Aug 1984
 Timeman One (Bourne Educational) Sep 1983
 Toolbox (BBC Soft) Mar 1984
 Transistors Revenge (Softspot) June 1984
 Vampire Castle (Micrograf) Aug 1984
 Vortex (Software Invasion) Sep 1984
 Vu-File (Psion) Nov 1983
 White Knight (BBC Soft) Dec 1983
 Wordhang (Bourne Educational) Oct 1983
 Wordwise (Computer Concepts) Jul 1983
 Zany Kong (Solar Soft) Sep 1983

From Page 53

tacular with smooth, sprite-like performance equal to the best arcade games.

The use of sound was rather limited, with only single notes being used instead of the almost symphonious accompaniment given to so many of today's games. Truly the only real faults in such an excellent game.

Tarquin Thomas

Familiar uncle lacks polish

THE obligatory bad guy of this scenario is bearded, balding, bespectacled, and head of a giant electronics company. His name is **Uncle Claude** and I'm sure his face is familiar but I just can't place it...

His company produces a whole spectrum of electrical goodies. But in an effort to increase the value of his goods Uncle Claude is stockpiling his products - probably for 28 days!

Our hero, according to the

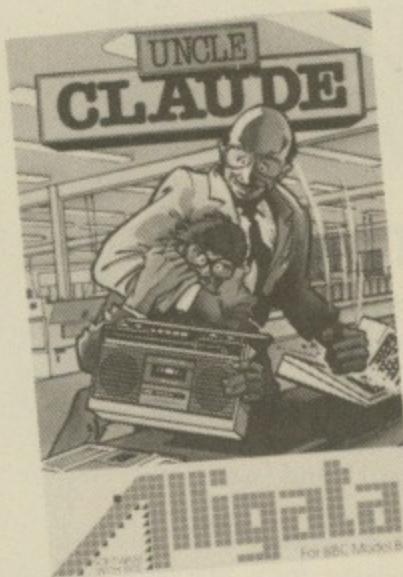

instructions on the disc cover, is named Micro Mickey. At least I think that's his name because when I loaded the program the title screen called him Electro Freddy.

This minor discrepancy aside, it is our schizophrenic hero's task to sneak into the factory during the night and load the products onto a conveyor for distribution.

However unknown to Mickey, Uncle Claude has been tipped off about Mickey's night shift and is lying in wait.

The cleverly written description on the cover whets one's appetite in preparation for the arcade action to come. Unfor-

tunately, as is often the case, the game itself was an anticlimax.

The animation was smooth, the characters colourful - there was even an ambulance which zipped across the screen to take Mickey away when he'd been zapped by Uncle Claude - yet the game had no character.

I found that I had to force myself to continue playing in order to write this review. I'm afraid it can only be described as unpolished.

I noticed that the title screen bore the name of Softspot, the company which produced the graphically stunning Transistors Revenge and the humorous and well presented Fruity Freddy.

I see now why they passed Uncle Claude on to Alligata.

Jon Revis

Frenzy rekindles arcade bug

TO BE perfectly honest I must admit I've always been an adventure fan first and foremost.

However Micro Power's **Frenzy** is the sort of gripping arcade game that makes me

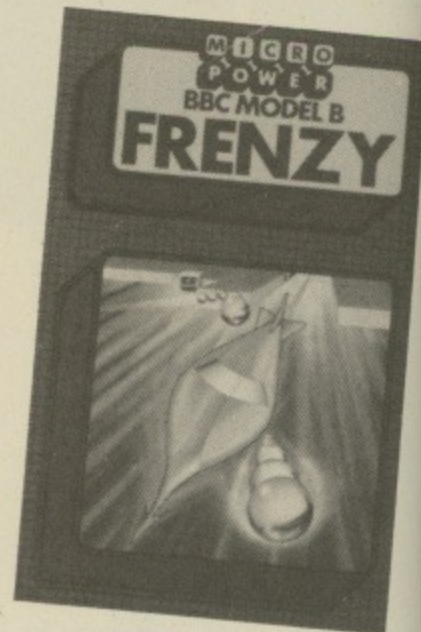

wonder how well-founded my convictions are.

While it is similar to Painter you soon realise how good a version it is.

You start with a blue screen containing an odd little object bouncing around - the Lepton. As you manoeuvre your craft across the screen it leaves a green trail behind it. When you regain the edge of the screen the area blocked off by this trail is coloured in.

Should the Lepton be inside this coloured area, bingo! You've completed your task, and you can sit back and have a small preen while the micro tots up your score.

Scoring depends on whether you've captured all the Leptons, how fast you managed this, and how much of the screen you filled. The craft has two speeds.

It's quite easy at first, but later screens become more difficult.

Chasers appear - small objects that plough round the perimeter and blow up your craft on contact - and the Leptons speed up and increase in number.

By screen eight, steering a clear path is about as easy as getting past an Italian footballer with your shins intact.

Difficult it may be, but it's addictive, and it has a number of nice features, such as being able to select to have the sound on or off.

The graphics are simple but good, and the control keys well positioned. There is also a high-score facility with the author's best score at the top.

An excellent idea, this, as it gives you a target to aim for. Not that I'm ever likely to beat him, as I have all the manual dexterity of a dead slug.

James Bibby

Plundering sounds like a good idea, but...

I CONSULTED the ship's display. The lookout had just sighted a warship. Should I be bold and order fully-fledged aggression? Or was a cautious retreat to replenish supplies at Port Casablanca to be the order of the day?

I reflected on my previous battle. I had captured 3,000 gold pieces from a galleon but at the cost of many damage points to the ship and several of my crew. Had it been worth it?

That could be described as the main course of the bill of fare served up by **Plunder** (Strategy Games). The scenario takes us back to 1587 where the Spaniards are shipping gold from America to finance the preparation of the Armada. Your ship must intercept and force them to surrender their gold.

The main display consists of a neat but rather simple map of the



Atlantic. Your ship sails on in changing weather until it locates an enemy. If you decide to attack, the screen displays both

ships close up and the battle begins.

This is the most disappointing part of the game. The ammunition fired by each ship is invisible and the player has no control over the battle except to decide whether or not to board the enemy.

If your ship is the worse for wear you can steer it into port for repairs, but this costs you hard-earned gold.

The graphics are hardly going to set the world alight but any such offering in this type of game is something of a bonus. The sound is disappointing.

My overall impression is that it is interesting idea which could have been executed better. See it for yourself before you buy.

Vijay Sundaram

TECHNOMATIC

BBC Computer & Econet Referral Centre
01-208 1177

All prices exclude VAT & carriage. Please add VAT and carriage: (a) £8; (b) £2.50; (c) £1.50; (d) £1

NOVEMBER '84

ACORN COMPUTER SYSTEMS

BBC Model B Special Offer.....	£320 (a)
BBC Model B + Starter Pack.....	£348 (a)
BBC Model B + DFS.....	£409 (a)
BBC Model B + Econet.....	£389 (a)
BBC Model B + Econet + DFS.....	£450 (a)
BBC Dust Cover.....	£4 (d)
Pair of Joysticks.....	£14.50 (d)

UPGRADE KITS

A to B.....	£65 (d)	Installation.....	£20
ACORN DFS Kit.....	£95 (d)	Installation.....	£15
Econet Kit.....	£55 (d)	Installation.....	£25
Speech Kit.....	£47 (d)	Installation.....	£15

ECONET ACCESSORIES

Terminator (Two reqd per installation)	£31 (c)	File Server Level II.....	£216 (c)
Clock with psu.....	£35 (c)	10 Station Lead Set.....	£26 (c)
Printer Server Rom.....	£42 (c)	Extra Econet cable..	£1.50/m (d)
File Server Level I.....	£86 (c)	Econet User Guide.....	£10 (d)

ACORN BITSTICK

The Acorn adaptation of the renowned 'Bitstick' graphic CAD package — the "expensive joystick" that lets you exploit the powerful capability of the BBC micro to the full. The joystick is of a robust design which achieves remarkable precision without fiddliness. Total control is available from the joystick using the on-screen menu. It can draw freehand or follow lines of shapes chosen with high accuracy, and colours can be chosen from a palette displayed on the screen. Any part of a drawing can be magnified, by a virtually unlimited number of times, and upto 48 drawings can be saved on a single disc. The discs use a visual library system for easy identification. In spite of its powerful features, the Bitstick is extremely friendly and easy to use, due to menus being displayed on the edge of the screens.

£328.00 (a) FX80 dump routine for the bitstick available.

TORCH UNICORN PRODUCTS

The TORCH Unicorn system has been in the field for over two years and is now a proven Z80 system for the BBC. It gives you the potential to expand which no other system can currently offer. You can expand a single system with a 20Mb Hard Disc, have the processing power of a 32bit 68000 cpu with 256K ram and a UNIX operating system, or set up a network of upto 254 machines. All these capabilities are available NOW.

The TORCH UNICOMM Modem package is now available for the UNICORN range providing the benefits of the extensive TORCH communication packages. It offers three options: **Uniview** for viewdata services, **Uniterm** for terminal emulation, and **Unimail** which allows messages and files to be exchanged between Unimail/Torchmail/Torchmail-Plus users. Access to files can be controlled by heirarchical passwords which determine the extent of access.

Z80 Card ZEP100 with PERFECT Software Packages	
+ Z80 Basic.....	£299 (a)
Z80 Disc Pack ZDP240 with software as above.....	£699 (a)
20Mb Hard Disc + 1 x 400K Floppy Drive.....	£1,950 (a)
UNICOMM Communications Package + modem.....	£161 (a)
Unicorn 68000, Unix OS/Z80B/256K, 20MB Hard Disc, 400K Floppy.....	£2995 (a)



A BBC Family System

ACORN Z80 2nd Processor

This processor converts your BBC into a complete business micro with all the computing power a professional would need. The system is CP/M based and is supplied with a very extensive software package. The package includes three office productivity programs, (memoplan, fileplan and graphplan), Systems generator program, three programming languages plus the ACCOUNTANT business program. Software is accompanied by extensive manuals that not only get you started but also answers your whys and hows.

All for only £399 (a) (incl VAT)

ACORN 6502 2nd Processor

This processor is designed for the serious computer user who wants to get even more out of his computer. This processor provides increased memory — allowing up to 44K for Basic programs and up to 60K for assembly language programs, regardless of screen mode in use. (ideal for VIEW). An increase in speed means that programs run up to 50% faster. The second processor/BBC combination offer computing power comparable to systems costing twice as much. £175 (a)

TORCH GRADUATE SYSTEMS

This latest addition to the range of BBC upgrades will upgrade your BBC to a powerful 16bit business computer and make it disc & hardware compatible with the IBM PC. Its MS/DOS is customised to IBM compatibility allowing access to the massive range of IBM compatible software, programming aids, compilers and languages. It uses A8088 CPU at 5MHz, 128K or 256K ram, single or dual drive, software compatibility allows LOTUS 1-2-3, and other popular IBM PC business programs to run. Connection of the Graduate is simple, with just a connection to the 1Mhz Bus. The disc drives can be used in both BBC and IBM PC mode without needing an Acorn Disc Interface in the computer. The top-of-the-market GRADUATE Model G800/2 will come complete with the superb Xchange suite of programs, comprising a full feature word processor, a financial planner, a database, and a business graphics package. Although these programs are in modular form, they can be linked together to form an integrated software system that allows you to switch instantly between various tasks and to exchange the information between programs. G800/2 £945 (a) Full spec & prices on application.



PRINTERS

ALL PRINTERS HAVE A 12 MONTH GUARANTEE

DOT MATRIX

This month we are adding the new **KAGA** printers to our range of quality dot matrix printers. These printers, with their Epson compatible control codes are available in 80 col & extra wide 156 col versions. Features include NEAR LETTER QUALITY print using a 23 x 18 matrix, Dot addressable graphics in 8, 9 & 16 pin modes. Text modes include Normal, Italic, Enlarged, Condensed, Super & Sub script, Proportional spacing. Defined characters can be placed in ROM to give personalised print. An intergral 3K buffer, both friction & adjustable tractor feeds with built in paper roll holder, etc. makes these superb 'value for money' printers unique.

KP810 (80 cols) £249 (a) (with free BBC cable)

KP910 (156 cols) £375 (a) (with free BBC cable)

We continue to supply the ever popular, definitive **EPSON** range. This 'industry standard' range provide reliability and quality 'second to none'. The budget RX80FT Dot Matrix, has 100cps and all standard printing and graphic functions as well as friction and tractor feed. The deluxe FX80 has all the above, as well as a 160cps, buffer, programmable characters etc. For wider paper use — up to 15" — the RX/FX100 are ideal.

RX80T £215 (a)

RX80FT £230 (a)

FX80 £318 (a)

RX100 £345 (a)

FX100 £450 (a)

DAISY WHEEL

The Brother HR15 daisy wheel offers features normally found in printers costing far more. Features include: 14 cps, 3K buffer, proportional spacing, underlining, bold and shadow printing, two colour printing, super & subscript and many other features. Centronics parallel interface is fitted as standard.

BROTHER HR15 £349 (a) (With free BBC Cable).

The JUKI 6100 daisywheel with 20 cps, 2K buffer, and switchable 10, 12, 15 cpi + proportional printing. A linear motor ensures optimum reliability.

JUKI 6100 £345 (a)

GRAPHICS PLOTTER/WORK STATION

Equally at home in the artists studio, hobbyists workshop, science lab or a classroom, this system has something to offer for everyone. The 3 colour graphics plotter provides both precision and versatility. The carriage can be moved with an accuracy of 0.025cm over an A4 area — the plotter being able to accept paper and far thicker materials at sizes of up to A3. The basic plotter carries 3 colour pens each of which is software selectable. Additional accessories greatly enhance the versatility of the unit without loosing the accuracy. The servo controlled drill/router, and scribe can be used on various materials. A unique Opto Sensor (using a Hewlett Packard device) turns the plotter into a high-res scanning digitiser to read & store whole diagrams and photographs.

Workstation Complete £490 (a);

Basic Plotter £270 (a).

Software on Disc £3.00; Opto Sensor £72.

Power Supply: PS12V £42; PS24V £78.

Drill/Router Attachment £79; Scriber £7.

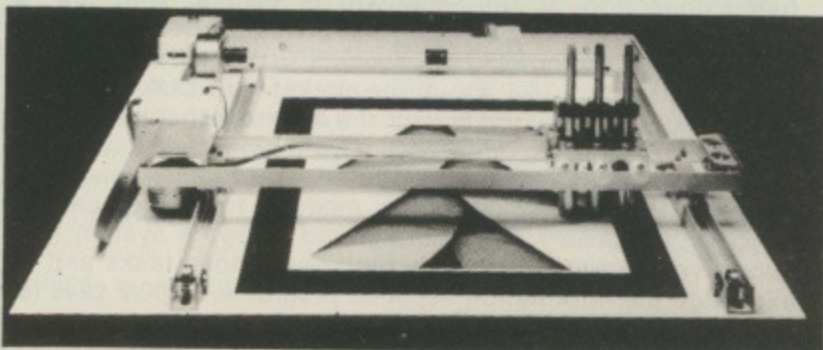

TECHNOMATIC

All prices exclude VAT

PRINTER ACCESSORIES

EPSON

Paper Roll Holder £17 (d) FX80 Tractor Attachment £37 (c).

Interfaces: 8143 RS232 £28(c); 8148 RS232 + 2K £57(c);

8132 Apple II £60(c); 8165 IEEE + Cable £65(c).

Serial & Parallel Interfaces with larger buffers available.

Ribbons: RX/FX/MX80 £5.00(d); RX/FX/MX 100 £10(d);

FX80 Dustcover £4.50(d)

KAGA TAXAN: RS 232 Interface + 2K buffer £85(c); Ribbon KP810/910 £6(d)

JUKI: RS232 Interface £65(c); Spare Daisy Wheel £14(d); Ribbon £2.50(d)

Sheet Feeder £199(a); Tractor Feed Attachment £99(a)

BROTHER HR15: Sheet Feeder £199(a); Ribbons Carbon or Nylon £4.50(a)

BBC Printer Lead: Parallel (42") £7(d); Serial £7(d)

Printer Leads can be supplied to any other length.

Plain Fanfold Paper with extra fine performance (Clean Edge):

2000 9.5" x 11" £13(b) 2000 14.5" x 11" £18.50(b)

Labels: 2-3/4" x 1.7/16" in quantities of 1000

Single Row: £5.25/1000 (d); Triple Row: £5.00/1000 (d)

PRINTER SHARER BUFFER

A unique delux printer buffer/sharer providing a simple way to upgrade your computer system by allowing greater utilisation of existing equipment by reducing the waiting time for printing documents. Data from three computers can be loaded into the buffer which will continue accepting data until its 64K storage is full. The buffer will automatically switch from one computer to the next as soon as that computer has dumped all its data. The computer is then available for other uses. This is a compact unit measuring 7cm x 17cm x 24cm. A LED bargraph indicates the memory usage, with LED indication showing from which computer the data is being fed from. There is simple push button control for PAUSE, RESET, and COPY facilities. The copy facility is ideal for continually printing copies of a document without 'tying up' the computer. Built in mains psu.

SP110 BUFFER/SHARER incl one cable set £275(b)

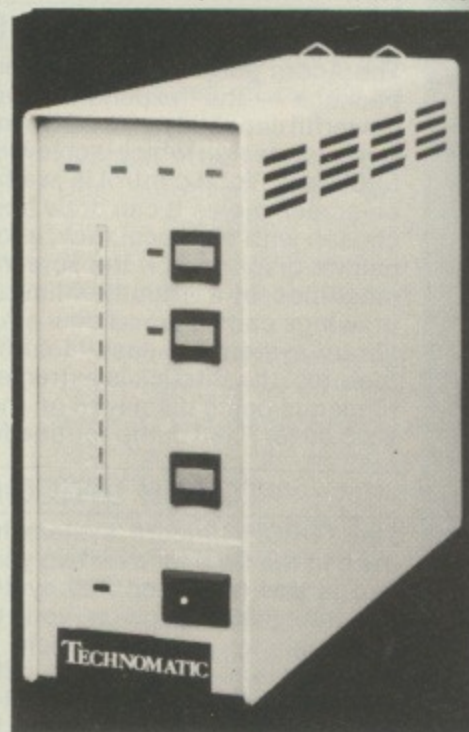

PRINTER SHARER

Three Computers to one printer (parallel)..... £65(b)

Six Computers to One Printer (parallel)..... £129(b)

Cables for Three Way Sharer..... £25(c)

Cables for Six Way Sharer..... £38(c)

COMPUTER SHARER

Two Printers to one Computer..... £19(c)

GRAFPAD

A low cost graphic tablet offering the performance & durability required by industrial and educational users. It is compact, accurate & reliable; working area 240 x 192mm + menu area. Comes complete with a CAD packag. £120 (b).

VIEW PRINTER DRIVER FOR FX80/KP810

This driver allows the use of all FX80s fonts to be used in text written using the VIEW rom. If user defined characters are held in the printer buffer they can also be used within the text. Manual and Disc includes examples of document layout and user definable characters. Supplied on 40 or 80 Track disc..... £7(d)

Printer Drivers for NEC PC8023, Brother HR15 and Juki 6100... £7(d)

01-208 1177

Please add VAT and carriage: (a) £8; (b) £2.50; (c) £1.50; (d) £1.
Carriage (a) sent by Datapost.

MONITORS

A choice of high quality RGB and Monochrome monitors are available. The British made **MICROVITEC** Std/Med/Hi Resolution 14" monitors offer a consistent reliable performance. Their resolution ranges from 452 pixels horizontal on the std res monitor to 895 pixels on the Hi res monitor. Std and Med res monitors are also available with RGB/PAL/Audio inputs. Dual input versions also available.

1431 Std. Res. RGB £175 (a); 1431AP RGB/PAL/AUDIO £225 (a);
1415 Med. Res. RGB £255(a);
1451 AP Med. Res. RGB/PAL/AUDIO £280(a);
1441 Hi-res RGB £420(a); 2031 20" Std Res RGB £260(a).

The **KAGA** Vision III 12" RGB monitor offers a superb performance but in a smaller cabinet with a genuine etched anti-glare screen. £358(a).

The Japanese made **SANYO** and the **KAGA** monochrome monitors provide an ideal answer for an 80 character hi-clarity display. A futuristic swivel base plinth with integral clock is available for the Kaga monochrome monitors as an optional extra.

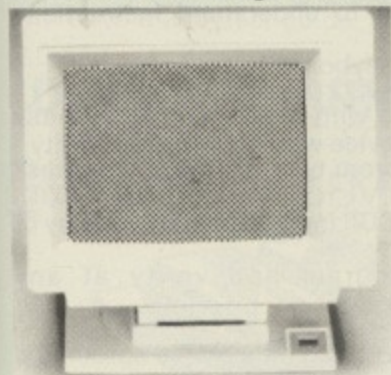

KX1201G with stand

SANYO DM 8112CX Hi Res Green Screen.....£99 (a)
KAGA KX1201G 20MHz Hi Res Green with etched screen....£106(a)
KATA KX1201A 20MHz Hi Res Amber with etched screen.....£114(a)
Swivel Base for Kaga Green (fitted with digital clock).....£22.50 (c)
Note: All monitors are supplied with free BBC leads.
BBC Leads: Kaga RGB £5;
Microvitec £3.50; Monochrome £3.50 (d)

VIDEO DIGITISER

A high quality yet cost-effective unit offering uses for the scientific, educational and home user. Feeding in a video signal (this can be from a camera, VCR etc) will output to the BBC a high quality picture, with eight different grey levels. This picture can be stored on disc, manipulated or dumped to a printer. The friendly, yet sophisticated menu driven software comes complete with an Epson printer dump. £213(a).

SANYO DRIOI DATA RECORDER

A high quality tape recorder with circuitry specifically designed for recording. Having switch selectable normal/data positions, as well as cue/review and a tape counter, it makes this recorder an ideal choice for anyone wanting a reliable tape storage device. £30 (c). including free lead. Extra leads £3.00 (d) Cassette £3.00 (d).

RH LIGHTPEN

A superior quality lightpen, features including: adjustable sensitivity, LED output to show data transmission, microswitch tip. Full software backup. £39 (c). The 'Lightpen Colour Graphic Software' pack helps you to draw line drawings as well as more complex drawings. Colour fill, point plotting, line, square, triangle, circle XY rulers are all available with rubber banding facility. £7 cassette, £9 Disc. The 'Artfun' pack provides full interaction between pen and screen. Allows your initial design to be shrunk into a high res format, and these images can be stored for subsequent use. £7 cassette. The 'Word Master' encourages the use of correct grammar and is an excellent aid. £7 on cassette. The 'Ed Master' uses a quiz format, and up to 160 questions may be programmed by the teacher. £7 on cassette (d).

RAINBOW LIGHTPEN

Allow your child's creativity to run wild in colour, and develop their artistic potential — allows colour displays to be instantly drawn. Superb software includes facilities of saving and loading screens as well as an Epson screendump. £10.35 (c).

DISC DRIVES

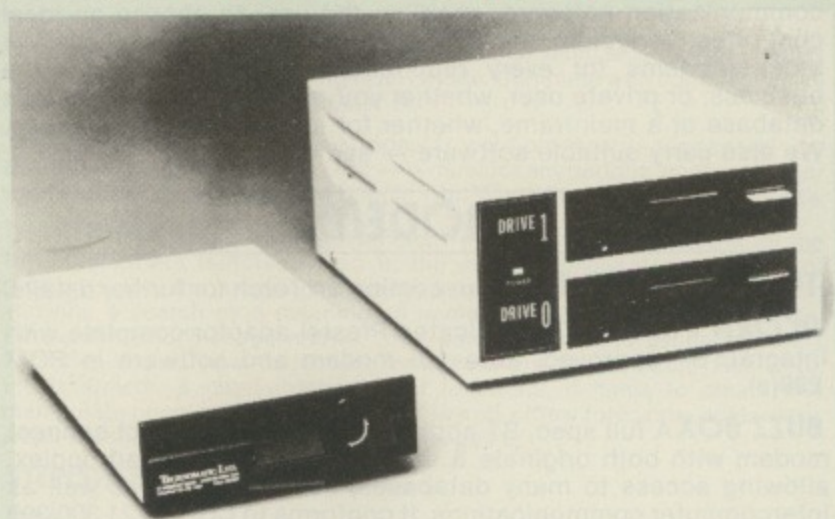

Technomatic Disc Drives offer the best value for money. They come fitted with high quality slimline Japanese mechanisms & represent the state of art in disc drive technology. They are built to highest standards in design and production, and are all tested to their full performance capability before packaging. All drives are available with or without integral power supply. Dual Drives with PSU are supplied with generously rated integral switched mode power supplies. All 80 track TEAC drives are fitted with 40/80 Track switching at no extra charge to the user. Attractively designed steel casings are painted in hard wearing BBC matching beige paint: All drives can operate in single or double density modes. Drives are supplied complete with necessary cables, manual and formatting disc and are ready to be connected to the computer.

Single Drives

100K 40T SS:TEAC £100(a); TEC with psu £135(a)
200K 80T SS: 40/80T TEAC £155(a) TEC with psu £165(a)
400K 80T DS:40/80T TEAC £185(a) Mitsubishi with psu £195(a)
3" 100K HITACHI Drive £115(a)

Dual Drives

2 x 100K 40T SS with psu: TEAC £300(a) TEC without psu £225(a)
2 x 200K 80T SS with psu 40/80T TEAC £375(a) TEC without psu £275(a)
2 x 400K 80T DS with psu 40/80T TEAC £400(a)
Mitsubishi without psu £325(a)
2 x 400K 80T DS with psu Mitsubishi £400(a).

OFFER

SCOTCH 3M DISCS

**Authorised Distributor
Data Recording Products**

This month we are offering these high performance discs at a bumper bargain price — not to be repeated again. The current offer will be valid for orders received until 30th October only. These discs are manufactured with advanced manufacturing techniques that have enabled 3M to set the industry standard. Their quality is such that their error free performance is guaranteed for life.

Discs in pack of 10 (c): 40T SSDD £12.50(c) 40T DSDD £17(c) 80T SSDD £21(c) 80T DSDD £22(c)

OFFER

DISC ACCESSORIES

Single Disc Cable £6 (d) Dual Disc Cable £8.50 (d)
10 Disc Library Case £1.90 (d) 30 Disc Case £8.00 (c)
Lockable Storage Boxes: 30/40 Discs £14(c) 100 Discs £19 (c)

The FLOPPICLENE disc head cleaning kit is the ideal way to ensure the optimum performance of your drives. The use of disposable cleaning discs eliminate the risk of recontamination and abrasion of the sensitive disc heads and ensure continuously reliable data capture and transmission.
Floppiclene with 20 disposable cleaning discs. £14.50 (b)

COMMUNICATIONS

We offer the customer a choice of modems and suitable communication software, enabling the user to choose an ideal cost-effective system, perfectly suited to his individual needs. We stock modems for every requirement, whether it is for the business, or private user, whether you require access to a public database or a mainframe, whether for local or international use. We also carry suitable software — see our section on ROMS.

MODEMS

TORCH UNICOMM See our section on Torch for further details.

ACORN PRESTEL The dedicated Prestel adaptor complete with integral, BT approved, auto-dial modem and software in ROM £99(a).

BUZZ BOX A full spec, BT approved, pocket size, direct connect modem with both originate & answer modes, full & half duplex, allowing access to many databases, bulletin-boards as well as intercomputer communications. It conforms to CCITT V21 300/300 Baud standard. Battery/mains powered. £65(c) BBC Lead £3.50 External PSU £8.

B.T. approved

WS2000 A world standard direct connect modem switchable between 75,300/300,600,1200/75,75/1200 baud. It is compatible with Bell 103/113/108, 202 and CCITT V21 & 23 standards and allows you to communicate with virtually any computer system in the world. This is one of the new generation modems, that will probably cover any communications standards you would ever need. This is the modem that will cover Prestel, Micronet, Telecom Gold, Distel, Microweb, One-to-One, Bulletin Boards both in the UK and abroad, etc. etc. as well as user-to-user communication. It also has a rather useful facility of 'Reverse-Prestel' mode i.e. 75/1200 so that you can communicate with other users who only have a standard 1200/75 type modem. What possibly gives this modem its biggest advantage is its option of computer controlled switching between all modes of operation. In addition, separate auto-answer and auto-dial cards are available, giving this modem possibly the greatest potential of all. Mains powered. £129(c). Please phone/write for details of optional extras.



TELEMOD-2 A BT approved modem complying with CCITT V23 1200/75 Duplex & 1200/1200 Half-Duplex standard, that allows communication with Viewdata services e.g. Prestel, Micronet etc., as well as using 1200 Baud for communicating with other computer users. Mains powered. TELEMOD 2 £65(b) BBC Lead £3.50

TERMI This is a semi intelligent terminal emulator allowing the BBC to act as a dumb terminal, slave BBC graphics terminal, or VT52 terminal. The rates at which data is sent or received is easily set up with rates of up to 4800 Baud with 40/80 col. selectable. Allows files to be transmitted from disc, or a copy of incoming data to be sent to a file or to a printer. (Termi is not suitable for PRESTEL). £28(d).

COMMUNICATOR This is a full 80 col VT100 terminal emulation program on 16K eeprom. It is a more advanced program than TERMI and features easy to follow screen menus. The rate at which data is sent or received is easily set up with rates up to 19200 Baud with 80 column text. Allows files to be transmitted from disc, or a copy of incoming data to be sent to a file or to a printer. (Communicator is not suitable for PRESTEL). £59(d).

COMMSTAR This intelligent communication facility is extremely easy to use yet very versatile. It features a terminal mode, a full VT100 emulation mode and a special PRESTEL mode. In Terminal mode, all input may be copied into a buffer in memory over which full control is provided. Controls of protocols is very simple and any type of file (not just ASCII) may be sent using XModem protocols. The Emulation mode may be used using a disc based emulation file to emulate virtually any terminal type including VT100, within the capabilities of the BBC. In PRESTEL mode all normal Prestel features are available, including downloading of software, saving and retrieving of pages etc. etc. £29(d).

TECHNOMATIC

All prices exclude VAT

EPROMER II

Our current version of the highly popular Eeprom programmer is now being enhanced to provide more and better facilities for easy programming by the user. The software will maintain its superiority over all currently available similar programmers. The range of eeproms handled has been widened to include the eeproms with lower programming voltage and eeproms which can be programmed using the fast algorithm. Control of all operations has been moved to the keyboard. The screen display has been improved to give more information. The screen editing facilities have also been modified to simplify the data entry.

Preliminary Information

- * The new Eeprom Programmer will now program 2516, 2532, 2564, 2716, 2732, 2764, 27128 and 27256 + 5v eeproms, and all but the 27256 in a single pass.
- * The programmer will be supplied with integral power supply, and interfaces with the BBC via the 1MHz bus. It is fully buffered and complies with Acorn protocols. There is no power drain from the computer.
- * No knobs or switches to fiddle with — total control from the keyboard.
- * Fully software driven with easy to understand instructions displayed on the screen.
- * Eeprom type selectable from the keyboard.
- * Selectable programming voltage 25/21/12.5V.
- * Defaults to normal programming with high speed algorithmic programming selectable, for a device with suitable capability.
- * Continuous screen display of eeprom type, option and address range selected.
- * Full screen editor with HEX or ASCII input. Constant display of logical eeprom address.
- * Can read, blank check, program and verify at any address/addresses on the eeprom.
- * Full Tape/Disc filing facility.
- * Several basic programs can be entered on a single eeprom and called up with individual name.

£102(b)

ATPL SIDEWISE ROM EXPANSION BOARD

This is a well constructed expansion board that does not require soldering in its installation. It will give you an additional twelve sockets, with 16K of battery-backed RAM option. Several link-selectable options include the choice of type of Eeprom, and a 'write protect' for the RAM option. All the busses are full buffered. £39(d).

EPROMS 8K 2764-25 £4.90(d); 16K 27128-30 £18.00(d).

RAM 8K standard power 6264-15 £26(d); 8K low power 6264LP-15 £31(d).

SMARTMOUTH

The Original 'Infinite Speech' Synthesiser — Still the Best!

A ready-built totally self-contained speech synthesiser unit, attractively packaged with built in speaker, Aux. output socket etc. Optimum sound quality is achieved due to a tailored frequency response audio stage. It allows the creation of any English word with both ease and simplicity, while, at the same time, being very economical in memory usage. You can easily add speech to most existing programs. Due to its remarkable infinite vocabulary, its uses spread throughout the whole spectrum of computer applications — these include educational, industrial, scientific, recreational etc. — simply plugs into the User Port. No ROMs are needed. Smartmouth is supplied with demo and development programs on cassette (easily transferred to disc) and full instructions. £37(c).

UV ERASERS

UV1T Eraser with built-in timer and mains indicator. Built-in safety interlock to avoid accidental exposure to the harmful UV rays. It can handle up to 5 eeproms at a time with an average erasing time of about 20 mins. £59(b).

UV1 as above but without the timer. £47(b).

For Industrial Users, we offer UV140 & UV141 erasers with handling capacity of 14 eeproms. UV141 has a built in timer. Both offer full built in safety features UV140 £61; UV141 £79(b).

'TIME-WARP' REAL-TIME CLOCK CALENDER

A low-cost compact unit that opens up the total range of Real-Time applications, and adds a new dimension to the personal computer. Though built to exacting professional standards, it is at a price previously unattainable, and brings it within reach of all BBC Computer owners. With its full integral, battery backup, possibilities include an Electronic Diary, continuous display of 'on-screen' time and date information, automatic document dating, precise timing and control in scientific applications, recreational use in games etc. — its uses are endless and are simply limited by ones imagination. Simply plugs into the User Port — no ROMs needed. Extensive applications software supplied on cassette (easily transferred to disc) and full instruction manual. Please phone for details. £29(c).



01-208 1177

Please add VAT and carriage: (a) £8; (b) £2.50; (c) £1.50; (d) £1
Carriage (a) sent by Datapost

ACORN IEEE INTERFACE

This interface enables a BBC computer to control any scientific and technical equipment that conforms to the IEEE488 standard, at a lower price than other systems, but without sacrificing any aspect of the standard. The interface can link up to 14 separate IEEE compatible devices. Typical applications are in experimental work in academic and industrial laboratories, with the advantage of speed, accuracy and repeatability. The interface is mains powered and comes with cables, IEEEFS ROM, and user guide. **£282(a)**

ACORN TELETEXT INTERFACE

This interface enables a BBC Computer to receive and store teletext information transmitted by both BBC and ITV. In addition it allows the downloading of transmitted software. The unit comes with a ROM and user guide. **£195(b)**

DATABASE MANAGEMENT SYSTEM

Gemini DATAGEM

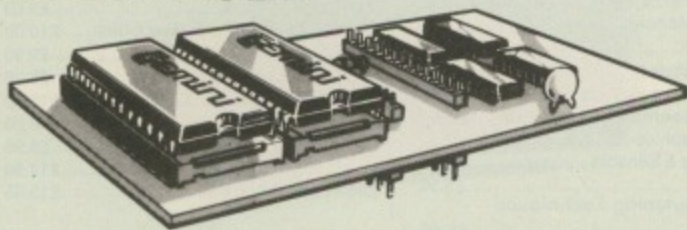

The Definitive Random Access, 24K ROM Based DATABASE MANAGEMENT SYSTEM.

Datagem is the first truly flexible database for the BBC Micro that can make your system really useful and efficient, saving you money in the long run. The system includes a carrier board containing two Eproms, demonstration applications disc in both 40/80T, professional documentation with quick reference card, and 'Trans' utility program. Features include: *almost unlimited file size (max 10MByte) *supports up to 4 drives *Max of 5000 records per file *max 6K record size *max of 62 fields *9 level hierarchical search system with facilities to store results of searches. Searches can be any one of the following: Search, Include, Exclude, Combine, Common or Difference *user defined variables *generates form letters from records. Please ask for leaflet. **£112(c)**

ACORN/MIIRLE Business software

A well designed, cost effective business system, having the advantage of being able to purchase packages individually, with the option of, possibly later, linking them with other packages. **INVOICING, ORDER PROCESSING, ACCOUNTS RECEIVABLE, ACCOUNTS PAYABLE, STOCK CONTROL, PURCHASING, MAILING SYSTEM. £22(d) each.**

SPECIAL CLEARANCE OFFER

Hell Driver;	Swoop;	Galactic
Felix in the Factory;	Alien Swirl;	Commander;
Laser Command;	Demon Decorator;	Where?;
Martian Attack;	Android Attack;	Labyrinth of La
Cybertron Mission;	Danger UXB;	Coshe;
Alien Destroyers;	Footer;	Chemistry;
Chess;	Moon Raider;	Physics;
Escape from Moon	ZARM;	Constellation
Base Alpha;	Eldorado Gold;	Croaker.

Only £2.50(d) each

BBC FIRMWARE

VIEW Word Processor Rom on special offer at £48(c).

This is the new version V2.1. Advantages include being able to print straight from memory, as well as editing in any mode. Complete with comprehensive manuals to Acorns usual high standard.

WORDWISE One of the most popular word processors for general use **£34(d)**. Wordwise SpellCheck Disc — A must for any serious word processor user. Normal price **£16.50(d)**. If bought with Wordwise: No p&p and only **£14**.

ULTRACALC From BBC Publications: The only spreadsheet ROM for the BBC that offers features found in the most sophisticated spreadsheet programs, like the handling of labels as well as numbers as values, and allowing a search by a meaningful name instead of just a number etc. Efficient memory usage allows large spread sheets to be constructed. Facilities and commands include, variable width column, Sum, Replicate, Insert, Delete, & most mathematical functions. It helps to create and manipulate pricelists, balance sheets, payroll, c/flow forecasts, order entry, small databases, scientific calculations. **£69(c)**.

VIEWSHEET Ask for details **£52(c)**

BCPL A full implementation of the BCPL compiler language from Acornsoft. It consists of the BCPL language ROM and a disc containing the BCPL Compiler, a Screen Editor, a 6502 Assembler, other utilities and program development aids, and some examples of BCPL code. A comprehensive 450 page user guide is included. It can be used to develop games programs and commercial packages, to develop system software, to write control systems, and to produce programs which otherwise would need to be written in assembler. **£86(b)**.

BCPL CALCULATIONS PACKAGE: supplied on disc, it supports floating point, fixed point and fast integer calculations. It includes the BCPL calculation files, example files and a comprehensive user guide. **£17.30(b)**.

UTILITY ROMS

DISC DOCTOR This general purpose ROM adds 20 commands to the DFS system. It includes a formatter, sector editor, tape-disc & disc-tape routines, a powerful disassembler, commands for listing function key definitions for editing etc. This ROM will obviate the need to go for non standard DFS systems (with their inherent disadvantages) as it overcomes many of the Acorn DFS's shortcomings. **£28(d)**.

GREMLIN Contains a full machine code monitor including features such as a disassembler, memory move and search routines. Also feature a full expression evaluator and an assembler. Can single step through ROM & RAM as well as any sideways ROM. Works in any mode with full status display. Up to 8 breakpoints can be used and it has a special mode for debugging graphic programs. **£28(d)**.

EXMON This extended machine code editor provides 35 new commands. Features include machine code relocater, single stepping, memory search and full assembler & disassembler. **£20(d)**.

TOOLKIT This ROM adds 27 new commands to the BBC BASIC. These include a full screen editor, merge, relocating data in memory, program compactor, listing of variables and memory search. **£23(d)**.

CARETAKER This adds 17 new commands to the BASIC which include: renumber, squash, exchange insert, single key entry of BASIC keywords etc. **£28(d)**.

GRAPHICS ROM This ROM includes over 28 new graphics related commands which can be used in BASIC programs. Features include: sprites, LOGO Turtle graphics, fill routines, shading, large characters, rotation, scaling and 3D plotting all using '*' commands. **£28(d)**.

PRINTMASTER This ROM features the most versatile screen dump for EPSON MX/RX/FX80 and Kaga 810 printers. It supports three types of dumps. The first allows any graphics on the screen to be dumped. Colours appear as shades of grey. Any part of the screen can be printed at any position on the paper in any one of four orientations. The screen dump may be magnified by any factor x2, x3, x4 etc. A special feature allows true MODE 7 screen dumps with TELETEXT text & graphics. The second dump allows any text to be dumped whilst the third dump will print the contents of a file on disc whilst the computer is doing other things. This is not all. All printer functions can be called up using the '*' command. *DEFINE allows the user to define his own characters and store them. *GPRINT allows printing of enlarged text in any position, orientation, size & shade. *WINDOW allows windows to be defined in any size and position on the screen. **In short this one ROM does it all. £28(d)**.

SOFTWARE

CP/M SOFTWARE FOR TORCH Z80 ACORN Z80 PROCESSOR

We can now supply almost any CP/M based software package in a format suitable for the Torch Z80 and Acorn Z80 second processors. The following are generally available from stock.

DBASE II £365 (a) WORDSTAR £295 (a) MAILMERGE £145 (a)
WORDSTAR/MAILMERGE COMBINED £395 (a)
DBASE II TUTORIAL (All Lessons on Disc) £32 (c)
PROPASCAL £220(a) CP/M TUTOR £55(c)

Phone for your specific requirements.

Please specify the type of format (TORCH or ACORN) is required.

MICROTEXT

This authoring system was developed by the National Physical Laboratories. It is a programming system designed to simplify the production of a wide range of man-computer dialogues. Using Microtext's simple commands, the user can draw up any number of 'frames', each containing text and/or graphics. A series of frames build up into a complete module. Each program can consist of more than one module. Using Microtext, an expert in any field can construct their own complete courses of computer-based instructional material. Applications include interviewing systems, teaching packages, training courses and interactive demonstrations and simulations. Available on Cassette and Disc. £52(a) Disc; £43(c) Cassette.

RCORNSOFT (d)	Disc	Cass		Cass
S-PASCAL	£17.30	£14.65	MISSILE BASE	£5.00
LISP	£17.30	£14.65	PLANETOIDS	£5.00
FORTH	£17.30	£14.65	METEORS	£5.00
PICTURE MAKER	£10.00	£8.65	CAROUSEL	£5.00
TURTLE GRAPHICS	£17.30	—	MONSTERS	£5.00
CREATIVE GRAPHICS	—	£8.65	FORECAST	£5.00
HOPPER	£6.00	—	CHESS	£5.00
SNOOKER	£6.00	—	DRAUGHTS&REVERSI	£5.00
STARSHIP COMMAND	£6.00	—	BBC PUBLICATIONS	—
JCB DIGGER	£6.00	£5.00	VU TYPE	£11.65
AVIATOR	£15.65	£13.00	RECORD KEEPER	£14.00
CRAZY TRACER	£6.00	£5.00		
ELITE	£15.65	£13.00		

Elite Cassette & Disc versions available from stock. (Disc version for 40TSS or 80TDS).

Replica II 40 & 80 Track Versions available. £10.35(d)

Printer Drivers On disc 40 or 80 Track Disc
RX/FX80/KAGA/NEC PC8023/JUKI 6100/BROTHER HR15 £7(d).

Design Design is a second processor which allows information to be displayed in a format suitable for demonstrations, slide projections, handouts or presentations. Graphs, Pie charts & Bar Charts are quickly produced; automatically drawn & scaled. Versatile labelling facility, 24 User defined, 4 large macro characters plus screen dump facilities included. £16.50(d) Disc (80 or 40 Track).

Superplot Superplot is ideal for screen representations of mathematical functions. It will plot on automatically scaled axes, in Cartesian, Polar or Parametric co-ordinate systems and will allow overlapping of graphs. £16.50(d) Disc (80 or 40 Track).

Spellcheck Menu driven spelling checker for WORDWISE or VIEW. Dictionary contains 6000 words and is expandable to 17000 on 100K disc. £16.50(d) Disc (80 or 40 Track) Specify the word processor.

Masterfile A general purpose data base that is extremely useful, allowing vast amounts of information to be stored. The disc version allows up to 17 fields per record, and the only limitation as to the number of records is the capacity of the disc. Typically, using 5 fields, about 2000 records may be stored on a 100K disc. £16.50(d) Disc.

Teletext Pack An editor enabling colourful mode 7 screens to be quickly created. Powerful facilities including a graphics character definer, speed up screen creation and design. Screens can be loaded or saved in the normal way or specially saved as a Basic routine for use in other programs. On screen teletext tutor included in the package. Ideal for setting up prestel type displays £16.50(d) Disc (80 or 40T).

When ordering software on disc please specify track format (40/80)

VU-Type This is a powerful and versatile typing tutor developed and published in association with Pitmans. It is designed to enable you to acquire or enhance typing and keyboard skills. £11.65(d).

Record Keeper A personalised program for storing and retrieving data for a variety of purposes. Report facility lets you choose how to generate the layout of your data and display and print it. The program also contains alternative versions for transfer to disc. £14.00(d).

BOOKS

(No VAT p&p £1.50 per book)

Let your BBC Teach U To Program.....	£3.50	Disc Systems.....	£6.95
100 Programs for the BBC.....	£6.95	Discovering BBC M/Code.....	£6.95
30 Hour Basic.....	£6.95	Essential Maths BBC/Electron.....	£5.95
35 Educational Progs.....	£6.95	Forth.....	£7.50
6502 Applications.....	£10.95	Friendly Computer Book.....	£6.95
6502 Assembly Lang Programming.....	£13.95	Graphics on the BBC Micro.....	£6.95
6502 M/Code for Beginners.....	£5.95	Graphs & Charts.....	£7.50
6522 VIA Book.....	£4.50	H/Bk of progs/functions for BBC.....	£6.95
6809 Assembly Lang Programming.....	£13.95	Instant Arcade Games BBC.....	£2.95
Advanced Graphics with BBC.....	£9.95	Interfacing Projects BBC.....	£6.95
Advanced M/C for the BBC.....	£7.95	Interfacing the 6502.....	£10.95
Advanced Prog Tech for BBC.....	£8.95	Intro BBC Micro.....	£5.95
Advanced 6502.....	£11.75	Intro to Pascal.....	£12.95
Advanced User Guide.....	£12.50	LISP.....	£7.50
Assembly Lang Prog on the BBC.....	£8.95	Making Music on the BBC Computer.....	£5.95
Assembly Lang for the BBC.....	£8.95	Mastering CP/M.....	£7.95
Assembly Lang Prog for Electron.....	£26.00	Micro BBC Basic Sound Graphics.....	£7.95
Assembly Lang Programming		MOS Memory Data Book.....	£3.95
Birnbaum.....	£8.95	Prog. Micro with Pascal.....	£8.50
Basic Prog on the BBC Cryer.....	£5.95	Prog the BBC Micro.....	£6.95
Basic Rom User Guide.....	£7.95	Programming the 6502.....	£10.95
Basic II Rom User Guide.....	£4.00	Programming the 6809.....	£11.95
BBC Basic.....	£5.95	Programming the 8086/8088.....	£11.75
BBC Basic for Beginners.....	£6.95	Programming the BBC.....	£6.95
BBC Micro for Beginners.....	£6.95	Programming the Z80.....	£13.45
BBC Micro Disk Companion.....	£7.95	Start Prog with Electron.....	£5.00
BBC Micro Expert Guide.....	£6.95	Step by Step Programme Book 1.....	£5.95
BBC Micro Graphics & Sound.....	£7.95	Step by Step Prog Book 2.....	£5.95
BBC Micro in Education.....	£6.50	Structured Programming.....	£6.50
BBC Micro Revealed.....	£3.50	The Electron Book.....	£5.00
BCPL User Manual.....	£15.00	TORCH Z80 Disc Pack User Guide.....	£10.00
Beyond Basic.....	£7.25	TTL Data Book Vol-1.....	£9.00
CP/M Handbook.....	£10.95	TTL Data Book Vol-2.....	£8.20
Creating Adventure Progs.....	£6.95	BBC User Guide.....	£15.00
Creative Assembler for the BBC.....	£5.95	Using BBC Basic.....	£10.00
Creative Graphics.....	£7.50	Using Floppy Disks.....	£6.95
DIY Robotics & Sensors.....	£6.95	Using the 6502 Assembly Lang.....	£14.50
Disc Book.....	£3.50	Z80 Applications Book.....	£13.45
Disc Programming Techniques			
BBC.....	£6.95		

EDUCATIONAL PROGRAMMES

A selected range of cassette based software for all the family to enjoy and at the same time arouse curiosity and create an interest in computers. Apart from providing hours of fun they will also help teach the young ones fundamentals of English and Maths without them realising it.

Mr T's Alphabet Games Watch how quickly the children learn to identify, name & match the letters and also write them correctly. Amusing sound effects and animated graphics make learning fun. £7(d).

Number Gulper A gripping fast moving game that helps develop arithmetic skills. 19 levels of skill to cater for all ability levels. Even parents might find upper levels embarrassing. £7(d).

Words Words Words A stimulating game to help young children with reading & spelling. Pictures are shown on the screen and the child has to type in the name of the object shown. If correct, the object takes its place in a scene. When all objects have been correctly identified the scene comes to life. £7(d).

Tree of Knowledge A interactive program that teaches categorisation. The computer is first educated about a group of objects — e.g. plants or birds. The database, or tree created in this way is then used in playing a guessing game. Two sample databases are supplied on the program. New databases are saved and loaded from within the programs. £7(d).

Royal Quiz Pit your knowledge of Royalty against Anthony Holden, the Royal Biographer. Do you know who told the queen that she didn't recognise her "without her crown on"? The quiz will tease, teach and entertain. £7(d).

Science Fiction Quiz A SF quiz in the widest sense, especially adapted from the Weidenfeld Quiz book that will provide hours of edification and amusement. £7(d).

TECHNOMATIC LTD

MAIL ORDERS TO: 17 Burnley Road, London NW10 4ED
(Tel: 01-208 1177 Telex 922800)

SHOPS AT: NW London: 15 Burnley Road, London NW10 4ED
(⊕ Dollis Hill 2 mins walk, ample car parking space)

West End: 305 Edgware Road, London W2. Tel: 01-723 0233
(Near Edgware Road ⊕)

01-208 1177

All prices exclude VAT. Please add 15% VAT and carriage
(a) £8; (b) £2.50; (c) £1.50; (d) £1.00.

Carriage (a) by Datapost.

For fast delivery telephone your order quoting
VISA or Access card or official order number.
(Minimum telephone order £5)

OUR DOUBLE-SIDED 3" DISC DRIVE. A TRIPLE OFFER.

Opus have a triple offer of 3" disc drives for those who wish to improve their micros.

The disc drive is compatible with the BBC Micro, has a direct drive mechanism, is double-sided and comes with a comprehensive manual.

And with every purchase, a 3" utilities cartridge will come free.

Our offer also includes VAT, all necessary leads

and carriage along with a two year guarantee—which is a year more than any other company can offer.

You can order by posting off the coupon below or calling at Opus Supplies Ltd., 158, Camberwell Road, London SE5 0EE. 01-701 8668 or 01-703 6155.

We are open 9–5.30 Monday to Friday and 9.00–1.00 p.m., Saturdays.

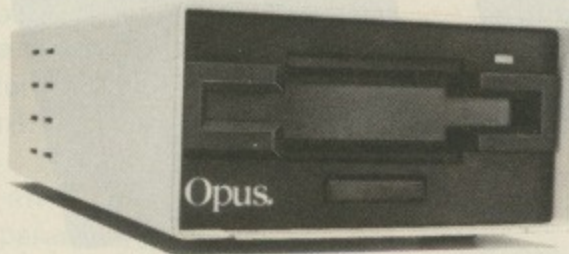

3" DISC DRIVE

You can buy this 500K (Unformatted) double-sided disc drive for the same price that other companies sell single drives for. The drive heads read and write to and from both sides of the disc cartridge, giving you twice the on-line capacity of single 3" drives.

Normally ~~£229.95~~

Now **£199.95**

SAVE £30

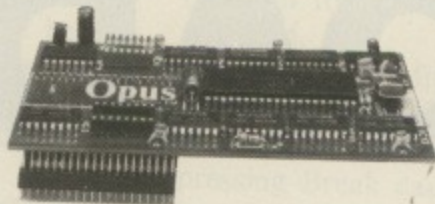
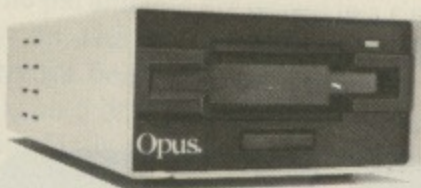

3" DISC DRIVE AND DOUBLE DENSITY INTERFACE

If you currently run your program on a cassette recorder, you'll need to upgrade your micro in order to use a disc drive. This offer not only gives you an interface, but it effectively doubles the capabilities of the drive—giving you 350K of usable capacity instead of the 200K normally achievable.

Normally ~~£359.95~~

Now **£299.95**

SAVE £60

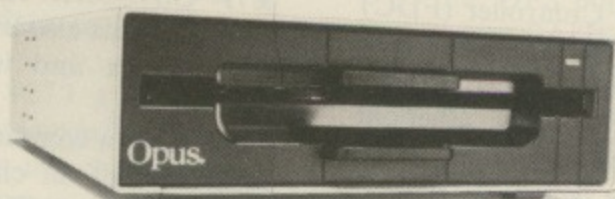
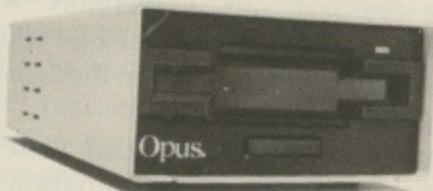

3" DISC DRIVE AND 5 1/4" DISC DRIVE

Both drives come 'daisy-chained' (or linked) together. They're completely compatible and will allow you to download all those programs you made on 5 1/4" floppy discs onto a robust 3" cartridge.

Normally ~~£379.95~~

Now **£329.90**

SAVE £50

Quantity	Description	Price
	TOTAL	

I enclose a cheque for £_____ or please debit my credit card account with the amount of £_____

My Access/Barclaycard (please delete) No. is _____

To: Opus Supplies Ltd., 158 Camberwell Road, London SE5 0EE. Please rush me the following: **(ALL PRICES INCLUDE VAT & CARRIAGE.)**

Name _____

Address _____

Telephone _____

BU34

Opus.
Opus Supplies Ltd.

**Don't run out of
memory, use
KEVIN EDWARDS'
key to unlock
available RAM**

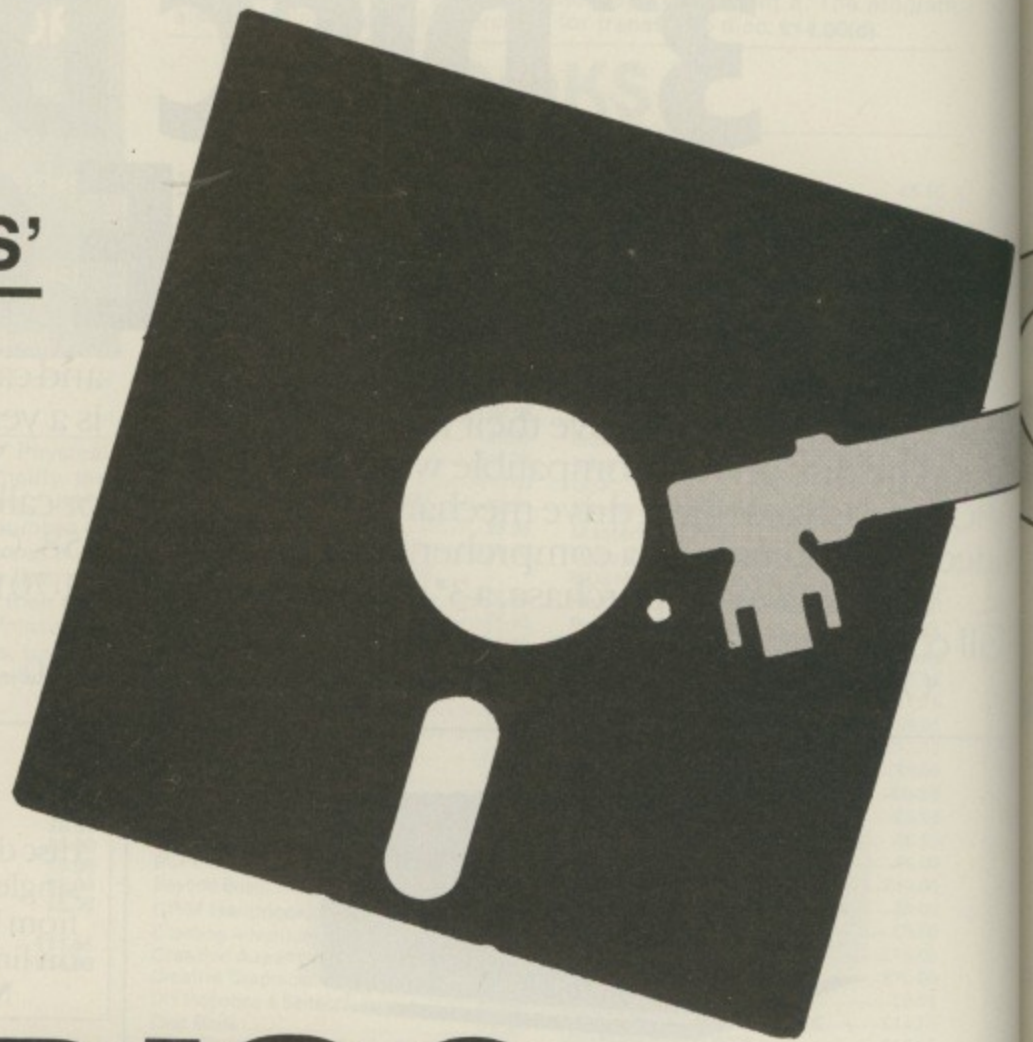

DISC LOADER

ANYONE who has ever used a micro with disc drives will know the incredible feelings of frustration and impatience that accompany a return to cassette systems – they're so slow and restrictive.

However, one problem with nearly all disc filing systems (DFS) is that they require a block of memory for their workspace.

On most systems the locations &E00 to &18FF inclusive are reserved for the DFS.

If you are not spooling or execing files then PAGE can be lowered to &1100, to claim back more of the valuable RAM.

Some programs that use the high resolution graphic modes will run out of memory when they are executed. One way round this is to load the program above the DFS's workspace, put the machine into tape mode, then download the program.

However, once this has been done the disc system is disabled, and no more data can be saved or loaded from the disc without corrupting the program in memory.

You can get around the problem though.

In this, the first of two articles, I will explain how to load data from disc into any section of RAM above, without the need to up or download it.

The second article will show you how to save data to disc without corrupting any programs present in memory. To do this you have to move the disc system's work space to another position in memory.

Unfortunately this is not as easy as it sounds. The only way to alter the block

of memory used by the DFS would seem to be to alter the DFS itself. This means re-programming an eprom with the altered code – a daunting prospect.

However we can write our own mini DFS.

The Floppy Disc Controller (FDC) chip in the BBC is the 8271, which is only capable of single density operations. Despite this chip being rather old fashioned, Acorn selected it in preference to double density FDCs.

Programming the 8271 involves reading or writing to locations &FE80 to &FE84, SHEILA &80 to &84.

These locations reflect the 8271's internal registers. Location &FE80 is the status register when reading, or the command register when writing.

Location &FE81 is the result register when reading, or the parameter register

when writing. Location &FE82 is the reset register, and is therefore write only. &FE83 is unused. &FE84 is used to transfer the data between the disc and memory and vice-versa.

We are already provided with the &7F OSWORD call to program the FDC, but this also uses part of the DFS work space and is useless for our purposes.

To issue a command to the 8271 we must first of all check the command busy flag is clear. This is done by testing bit 7 of the status register.

If it is set we loop round, testing the bit, until it is clear. When it is clear we can poke the command number into the command register which is located at &FE80.

The command number is different for various operations – loading, saving,

MEMORY USAGE

&80,&81	Low and high byte of the data destination.		
&82	Offset for &80,&81.		
&83	Completion flag.	&8B	Number of files on disc.
&84	Track number for read command.	&8C	File number counter.
&85	Sector start number.	&600-&6FF	Contains the file names, these are loaded from Track 0 Sector 0.
&86	Number of sectors left to load.	&700-&7FF	Contains the file attributes. (These are the load, save and execution addresses.) Also included are the sector address's for the files. These are loaded from Track 0 Sector 1.
&87	Number of sectors to be loaded from the present track.	&B00-&CFF	Contains the loading subroutine.
&88	Low byte of start sector.		
&89	High byte of start sector.		
&8A	Number of files on the disc. This is decremented when one of the file		

formatting and so on. For those interested in the technical details, a full set of the commands and parameters are given in the 8271 data sheets, available in the useful Hardware Guide for the BBC Micro from Wise Owl Publications.

Nearly all the commands need additional parameters, usually corresponding to the track number, sector address and sector size.

The parameters are issued in a similar way as the command. The only difference being that the parameter full flag is bit 5 of the status register and the parameter is poked into the parameter register, located at &FE81.

Once all the parameters have been sent to the 8271, the FDC will execute the operation specified. In all cases an interrupt will be generated when the operation is complete.

This indicates to the CPU (Central Processing Unit) that the command is complete and that the result register holds the outcome of the operation. The result register is located at &FE81.

If the command is a read or write command then an interrupt will be generated when data is required or waiting to be read.

To make the 8271 generate an interrupt when a data transfer operation must take place, the NON DMA (Direct Memory Access) mode must be selected.

When a NON DMA interrupt occurs, the data must be read or written immediately to location &FE84 or else the operation will fail.

It is for this reason that the interrupt generated must have priority over any other program currently being executed

as the timing is extremely critical.

All of the interrupts generated by the 8271 are Non Maskable Interrupts (NMI). As the name suggests, the interrupt cannot be masked by software.

The 6502 has a NMI pin, and when the input to this is low, the 6502 will begin executing a piece of code whose location is given by the contents of locations &FFFA and &FFFB, and will return back to the piece of code previously being executed when an RTI (ReTurn from Interrupt) command is executed.

On the BBC Micro the NMI routine is at location &D00.

You may have been wondering why pressing Break causes the contents of location &D00 to be changed to &40. This is because the &40 is the RTI instruction, and means that when a NMI occurs it will exit the NMI routine without performing any operation.

But when you issue commands to the DFS, the DFS puts the required NMI routine into PAGE &D. Obviously the routine will be different for load and save. You can see the difference by disassembling PAGE &D after a load or save operation.

Anyway back to the routine in question: the program puts a JMP (JuMP) instruction in PAGE &D so that when a NMI occurs, it will jump to a piece of code to handle the NMI.

The type of interrupt generated can be found by masking the bits in the status register. When the command has been completed, the result register must

be read. This will show if any error has occurred.

If bits 1 to 4 are unset then the completion is good, otherwise an error has occurred. If so, the operation is aborted and an error message printed.

To allow the use of memory above &E00 the loading routine has been located in PAGE &B and &C, normally used for the function key definitions and user defined characters.

This allows us to load programs and data into any memory location between &E00 and &7FFF with a single call command. Unfortunately any programs which re-program the function keys or re-define the character set will corrupt the load routine.

To load a program you set the integer variable K% to the load address of the program - for example, K%=&E00 - and you then CALL&B00. If the program is Basic the value of PAGE and K% should be the same.

When the routine has been called, a menu of drive 0 files is displayed. Each file has an associated reference character.

Selecting a file is simply done by pressing the key corresponding to this character. The program will then be loaded into memory.

It should be noted that to stop the first few file names scrolling off the top of the screen, a VDU 14 command has been issued. This means that the Shift key must be pressed to reveal the remainder

From Page 63

of the file names, if any.

Also, the program only loads in multiples of one sector, that is, 256 bytes. This means a program of &24E bytes will take up &300 bytes when loaded in memory. This should be taken into account when loading several files into memory at once.

The program uses part of PAGE 0 and all of PAGES 6 and 7.

When you have finished typing in the program, save it. Once you have done this, run the program in the normal way. Now the machine code routine will have been assembled into memory starting at location &B00.

The next thing to do is to save the OBJECT code. This is done by typing:

```
*SAVE "LOADER" B00 D00 <Return>
```

You must now set up a boot file which

sets K% to the load address, changes the value of PAGE and loads in the program loader.

To set up the file type:

```
*BUILD !BOOT <Return>
```

The number 1 will appear on the screen. Now enter the following:

```
*FX15 <Return>
```

```
K%=&E00 <Return>
```

```
PAGE=&E00 <Return>
```

```
*L. LOADER <Return>
```

Pressing Esc will save the !BOOT file. To inform the micro that the !BOOT file is to be EXECed you must issue the *OPT 4,3 command.

After this has been done, booting the disc will set up the loader routine. To execute the routine type in the following:

```
CALL&B00 <Return>
```

● That should keep you busy for this

70	Select cassette filing system	320
	1200 baud.	
80-110	Load sectors 0 and 1 from track 0 into locations &60 &7FF.	330
120	Find out how many files are on the disc.	340
130-170	Display the file names.	350
180-190	Wait for a valid selection.	360
200-240	Find start sector for selected file.	370
250	Returns back to Basic if disc contains no files.	380
260-300	Calculate the track and sector address for the file.	390-450
310	Copy the load address in &80,&81.	460-470

month. Next month we'll look at the other side of the coin - actually saving your files onto disc in the first place.

TANDON SLIMLINE SINGLE DRIVE UNITS

	ex VAT	inc VAT
40 track 100K	£100.00	£115.00
40 track 100K low power model	£120.00	£138.00
40 track 200K	£135.00	£155.25
40 track 200K switchable to read 80 track	£145.00	£166.75
80 track 400K	£145.00	£166.75
40/80 switchable 400K	£145.00	£166.75

FOR DUAL DRIVES THE PRICE IS DOUBLE THE SINGLE DRIVE PRICE

- Other drives available - call us for details.
- All dual drives can be powered by the BBC Micro.
- Integral power supply is £35.00 inc VAT.
- The VAT inclusive price gives you a slimline metal cased drive/drives with all data and power cables, user guide and utility disc.
- Full 12 months guarantee.

Please add £8.00 for carriage by Securicor.
Allow 3 days for delivery.

ROM/RAM Sideways Extension by UDM

16K sideways RAM, write protectable. Selectable 2732, 2764, 27128 Eproms. No flying leads, no soldering - just plug in and go! Fits in with DDFS boards. 16 on board sockets. Turn pin sockets (does not damage existing sockets). Avoids overheating problems.
£47.00 inc VAT and p&p

SALE BARGAINS

100K Drives at £100.00 inc VAT
200K Drives at £130.00 inc VAT
400K Drives at £125 inc VAT (Full Height, limited quantity).
Add £3.00 for P&P
Please enquire for other bargains.

SINGLE/DOUBLE DENSITY FILING SYSTEM BY UDM

- Acorn compatible - runs BASIC, VIEW, WORDWISE, BCPL
- Compatible with 2nd processors, Teletext, Osword 7F
- Automatic switching between 40 and 80 track mode
- Automatic switching between single and double density
- Disc formatter in ROM
- Complete with manual

£96 inc VAT and p&p for D.F.S.

1.0 version now available

DISKETTES (per box of ten)

	Wabash	Datalife
40 tk ss sd	£14.50	-
40 tk ss dd	-	£18.00
40 tk ds dd	£19.00	£24.00
80 tk ds dd	£24.25	£29.35

EPROMS ex VAT inc VAT

2764	£5.50	£6.33
27128	£17.00	£19.55

Please add £1.00 p&p

DRIVE CASES

	ex VAT	inc VAT
Slimline	£12.00	£13.80
Full height	£15.00	£17.25

Please add £2.00 p&p

25 single sided double density diskettes in a 50 capacity storage box £34.50 inc VAT p&p.

25 double sided double density diskettes in a 50 capacity storage box £48.50 inc VAT p&p.

Empty 40-50 capacity storage box at £9.00 inc. VAT p&p

BBC Model B

£370 Inc. VAT

Monitors and Printers also in stock.

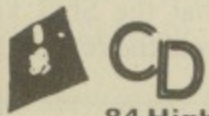

Dealer enquiries invited

CARSON DEVELOPMENTS (MU)
84 Highfield Road, Romford, Essex, RM5 3RU
Telephone: 0708 27043

PROGRAM DESCRIPTION

0	Store the track, sector and number of sectors to be loaded in zero page.	480	Wait until command is complete.	780	Saves A and Y on the stack.
10	Change &D00-&D02 to a JMP instruction.	490-500	Test to see that all of the sectors have been loaded.	790	Tests to see if the interrupt generated is a NON DMA request.
20	Set load address index register to 0.	510	Print a carriage return before returning to Basic.	800	Reads a byte from disc and saves it in main store.
30	Select NON DMA mode.	520-570	The main loading routine.	810	Restore the A and Y registers and exits the NMI routine.
40	Turn drive 0 on.	580-620	Routine to turn the drive on.	820	Check to see if the 8271 has caused the NMI.
50	Wait until drive is at operation speed.	630-640	Keeps reading the drive status register until the drive is ready for operation.	830	Check to see if the interrupt was generated because of an error.
60	Seek to track 0.	650-690	Selects the NON DMA mode.	840	If no error has occurred, set the completion flag.
70-450	Calculate the number of sectors to be loaded from the current track.	700-710	8271 parameter routine.	850-860	In the case of an error, print an error message.
80-470	Wait until drive is at operation speed before issuing the load command.	720	8271 command routine.		
		730-770	Puts a JMP instruction at the start of the normal NMI routine, so that my own NMI routine is executed.		

```

10 REM Disc Loader
20 REM By Kevin Edwards
30 REM (c) The Micro User
40 K%=&E00
50 FORL=0TO2STEP2:P%=&B00
60 IOPTL
70 LDA#&8C:LDX#12:JSR&FFF4
80 LDA#0:STA#80:LDA#6:STA#81
90 LDX#0:LDA#0:LDY#2:JSRMain_load
100 LDA#0:STA#8C
110 .Ready LDA#81:CMP#8:BNEReady
120 LDA#705:LSRA:LSRA:LSRA:BEQEmpty
:STA#8A:STA#8B
130 LDA#12:JSR&FFEE:LDA#14:JSR&FFEE
:LDA#0
140 .Loop1 LDY#0:LDA#8C:CLC:ADC#65:
JSR&FFEE:LDA#32:JSR&FFEE
150 .Loop2 LDA#608,X:JSR&FFEE:INX:I
NY:CPY#7:BNELoop2
160 INX:INC#8C:JSR&FFE7:DEC#8A:BNEL
oop1
170 LDA#15:JSR&FFEE:LDA#63:JSR&FFEE
180 .Get_key JSR&FFE0
190 TAX:SEC:SBC#65:TAY:CMP#8B:BCSGe
t_key
200 TXA:JSR&FFEE:INY:TYA:ASLA:ASLA:
ASLA:CLC:TAX:DEX
210 LDA#708,X:STA#8B:DEX:LDA#708,X:
AND#3:STA#89
220 DEX:LDA#708,X:TAY
230 DEX:LDA#708,X:BEQCalc_track
240 INY:JMPCalc_track
250 .Empty RTS
260 .Calc_track LDX#0
270 .Next_track LDA#89:BNEGreater
280 LDA#88:CMP#10:BCCMain_load1
290 .Greater SEC:LDA#88:SBC#10:STA#88
300 LDA#89:SBC#0:STA#89:INX:JMPNext
_track
310 .Main_load1 PHA:LDA#42C:STA#80:
LDA#42D:STA#81:PLA
320 .Main_load STX#84:STA#85:STY#86
330 JSRNMI_change
340 LDA#0:STA#82
350 JSRNon_DMA_mode
360 JSRDrive_on
370 JSRWait_for_speed
380 LDA#&69:JSRCommand:LDA#0:JSRPar
ameter
390 .Next LDA#0:STA#83:LDA#85:BEQNo
rual
400 LDA#10:SEC:SBC#85:CMP#86:BCSSma
ll
410 STA#87:LDA#86:SEC:SBC#87:STA#86
:JMPNormal1
420 .Small LDA#86:STA#87:BNELast
430 .Normal LDA#86:CMP#11:BCSMORE:S
TA#87
440 .Last LDA#0:STA#86:BEQNormal1
450 .More SEC:SBC#10:STA#86:LDA#10:
STA#87
460 .Normal1 JSRWait_for_speed
470 JSRLoad
480 .No_end LDA#83:BEQNo_end
490 LDA#0:STA#85
500 INC#84:LDA#86:BNENext
510 JSR&FFE7:RTS
520 .Load
530 LDA#&53:JSRCommand
540 LDA#84:JSRParameter
550 LDA#85:JSRParameter
560 LDA#&20:CLC:ADC#87:JSRParameter
570 RTS
580 .Drive_on
590 LDA#&3A:JSRCommand
600 LDA#&23:JSRParameter
610 LDA#&48:JSRParameter
620 RTS
630 .Wait_for_speed LDA#&6C:JSRComm
and:LDA#FE81:AND#4:BEQWait_for_speed
640 RTS
650 .Non_DMA_mode
660 LDA#&3A:JSRCommand
670 LDA#&17:JSRParameter
680 LDA#&C1:JSRParameter
690 RTS
700 .Parameter PHA
710 .Busy LDA#FE80:AND#&20:BNEBusy:
PLA:STA#FE81:RTS
720 .Command BIT#FE80:BMICCommand:ST
A#FE80:RTS
730 .NMI_change
740 LDA#&4C:STA#D00
750 LDA#NMI_routine MOD 256:STA#D01
760 LDA#NMI_routine DIV 256:STA#D02
770 RTS
780 .NMI_routine PHA:TYA:PHA
790 LDA#FE80:AND#4:BEQCheck
800 LDA#FE84:LDY#82:STA(&80),Y:INY:
STY#82:BNENEnd:INC#81
810 .End PLA:TAY:PLA:RTI
820 .Check LDA#FE80:AND#8:BEQEnd
830 LDA#FE81:AND#&1E:BNEDisc_error
840 LDA#1:STA#83:BNENEnd
850 .Disc_error JSR&FFE7:BRK:BRK
860 .Error_message
870 JNEXT
880 $Error_message="Load Error "+CH
R$0
890 END

```

This listing is included in this month's cassette tape offer. See order form on Page 213.

SIX OF ONE OR HALF A DOZEN OF THE OTHERS?

1 SCRIBE

THE PROFESSIONAL WORD PROCESSOR designed for the serious user ■ All operations fully prompted ■ No special knowledge of the computer system necessary ■ Document size NOT limited by computer memory ■ Automatic disc buffering ensures text is moved between disc and computer memory without user intervention ■ Up to 255 pages in a single document ■ 80 column display ■ on screen underline and right justify ■ See it as it will be printed. SCRIBE comes in a chip with 5 minute fitting instructions, utilities disc and manual. DISC MACHINES ONLY. **£59.95 + 60p p&p**

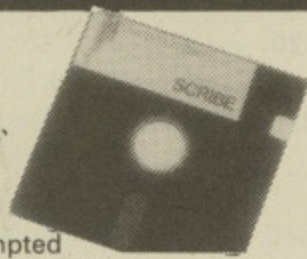

2 DATABASE

A superb information management system with an incredible operating speed. 96 fields per record ■ One record 2 Kb max ■ One field 900 characters max ■ 4000 records per database ■ 16 level conditional search ■ Find any record in 2 secs ■ Wild card search ■ Record match ■ 8 automatic sub indexes ■ Total flexibility of output via report writer with auto write back to any field ■ Maths pack ■ Semi programming language. Integrates with Scribe to give conditional search with MAIL MERGE and high powered report formatting. Database is in a chip. DISC MACHINES ONLY **£49.00 + 60p p&p.** Scribe & Database in one chip **£95.00 + 60p p&p.**



3 TYPEWRITER PRINTER

Based on the imperial 8008 this beautiful daisywheel typewriter features MERLIN'S own parallel interface tailored for your BBC computer.

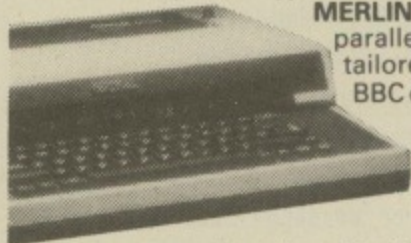

Included are ■ keyboard buffer ■ auto repeat ■ electronic tab set and clear ■ decimal tab ■ 20 character auto correction memory ■ auto underline compatible with SCRIBE.

Comes with carrying case, instruction manual and ribbon connection to your BBC computer.

£299.00 + VAT
Next day Securicor delivery £5.00

Additions to your computer system depend upon each other for best performance. How often have you asked if this or that program is compatible with some piece of hardware?

MERLIN products for the BBC computer are designed to complement each other and so get the best from your system. Rest assured when you buy MERLIN, each addition is compatible with the last and is made to be the best available in its field. Combined with one another they are unsurpassed in performance or value.

Purchasers of MERLIN software are provided with a free update service and an unmatched level of technical support.



MERLIN COMPUTER PRODUCTS

Please supply the following products/information (Delete as applicable).

QTY _____
QTY _____
QTY _____

I enclose £ _____ Inc P&P
My Credit Card No. is _____

Visa Access Tick which

Name _____

Address _____

To: MERLIN COMPUTER PRODUCTS
33/36 Singleton Street
Swansea SA1 3QN
Tel: (0792) 467980



4 DOUBLE-DOS

Double density disc interface for the BBC computer.

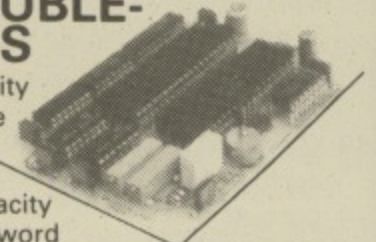

A high capacity database or word processor is enhanced even further with this state of the art disc interface.

The many features include ■ almost 800 Kb of CONTINUOUS file space on a standard 80 track disc drive ■ Automatically read standard Acorn files ■ Compensate for discs formatted in single density ■ Provide up to 156 files IN ONE DIRECTORY ■ Automatically read, write and format double sided drives to appear as one disc surface ■ Allow maximum use of MERLIN Scribe and Database.

Fitting to your computer is made exceptionally safe and reliable by providing connection via a flexible ribbon cable. Full instructions provided.

£109.25 + 90p p&p

5 DISC DRIVES

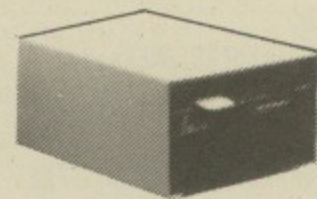

All of our disc drives are double density spec. and therefore if used in conjunction with DOUBLE-DOS give twice the standard Acorn disc capacity and feature head load light. Single drives are supplied in a double case to allow easy addition of a second drive.

D100 Single drive 5 1/4 D/D **£135.00**

D200 Dual drive 5 1/4 D/D **£267.00**

D400 single drive 5 1/4 double side D/D **£219.00**

D800 Dual drive 5 1/4 double side D/D **£349.00**

For switchable 40/80. Add £26.00

ONE YEARS GUARANTEE
Next day Securicor delivery £5.00

6 MERLIN HYPERDRIVE

FOR RELEASE NOV 84

A 2 Megabyte 5 1/4 ins floppy disc drive which will also automatically detect and read standard 40 and 80 track discs.

Size the same as a standard half height drive optional 400 Kb backup drive also available.

Ideal to maintain a large database or document file with high speed access. Requires Merlin Double Dos.

£575.00

AMX AMX MOUSE

POINTS THE WAY TO...

- **Faster interaction**
- **Creative Graphics**
- **Enhanced Programs**

With the AmX Mouse, from Advanced Memory Systems Ltd, the BBC Micro joins a new league of powerful user-friendly computers. Natural hand-eye co-ordination allows the MOUSE to position the cursor quickly and accurately. Alternatively by moving the MOUSE you can input specially written new software such as ARTWORX.

ARTWORX is a powerful graphics program allowing scope to produce amazingly vivid pictures and designs on your screen and printer. Simply point to any of the ICONS (small illustrations) and you select options of patterns and implements. Other options are offered by pull-down menus. All features can be activated using just the MOUSE.

The AmX Mouse package includes ARTWORX and an EPROM with software to enable you to use the MOUSE with existing programs and also lets you use the MOUSE's versatility in your own software. Just plug the MOUSE into the user port on a BBC Micro (model B) and the EPROM into a spare sideways socket.

Now simply fill in the coupon and we will send you an AmX Mouse with ARTWORX with our full no quibble money back guarantee. OR phone 0925 602690/62907 for instant Access or Visa orders.

ARTWORX graphics program

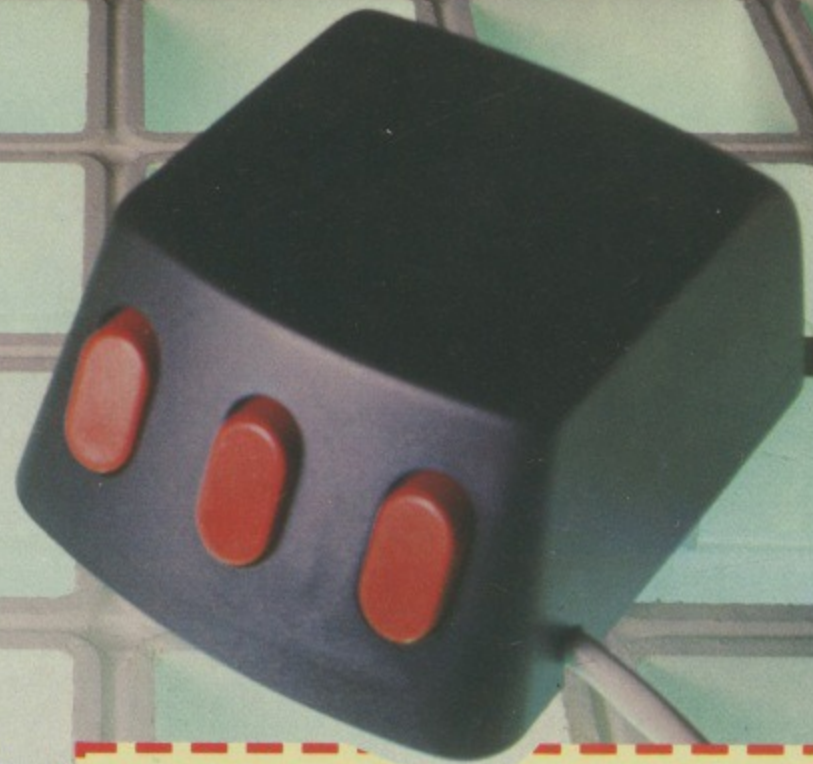
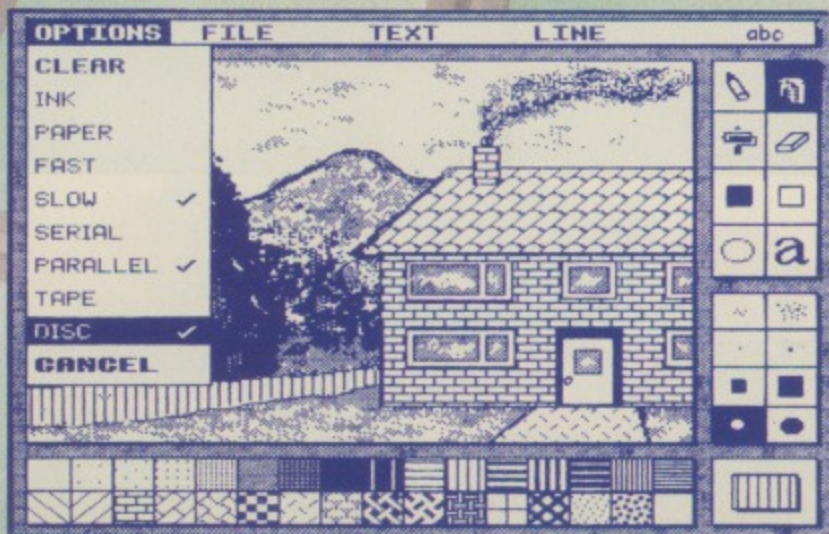

Please send No _____ **AMX MOUSE** packages (including **ARTWORX** and EPROM) at **£89.95** inc. VAT and P&P. I enclose a cheque/PO for £ _____ or debit my credit card.

Card No Visa Access

Name _____

Address _____

Signature _____ Date _____

(Please tick choice of media for **ARTWORX**) Cassette 3" Disc 5 1/4" Disc

To: **Advanced Memory Systems Ltd., Woodside Technology Centre, Green Lane, Appleton, Warrington, WA4 5NG, England.**

How to become a before committing y

The Owl and the Puppy-dog

Went to see

A beautiful sky-blue bote.

The took some money,

Which looked really funny

Wrapped in a £10 note.

-



Be a great writer getting yourself to paper.

It takes only two minutes and £59.80 to transform your BBC Micro into the heart of a word processor with VIEW from Acornsoft.

The VIEW word processing system is programmed into a single chip, a 16K plug-in ROM. Once it's installed into your BBC Micro – a simple job for your local dealer – you just switch on and VIEW is operating. (You can switch to other programs, like BASIC, with a single command.)

VIEW is a professional system, yet it's surprisingly straightforward to use.

And it's so outstanding it's won the 1984 British Microcomputing Award for Home Software.

All you do is type out your text on the keyboard, and view it on the screen.

VIEW can search, change and replace particular words whenever they occur in your text. It can swap paragraphs. Automatically alter page numbers. Even count words.

The possibilities are endless, because you can check, edit and change as much or as little as you like until you're satisfied. Then, with a single command, your final version will appear on the screen.

If you want to go even further, the simple addition of ViewIndex, just £14.95, means you can select and index words, complete with page or section numbers.

And of course, when you're ready, any printer that will operate with your BBC Micro will operate with VIEW. But if you want to use the printer's special facilities, such as bold printing or underlining, Acornsoft's Printer Driver Generator (£9.95 on cassette, £11.50 on disc) enables you to do so.

For the more specialised user who wants to take advantage of the extra power offered by the 6502 Second Processor, Hi-VIEW (£59.80) provides 47K of text space in any of the BBC Micro's screen modes.

So whether you're composing a 300 page business document, a letter to the gas board, or a bit of Victorian nonsense, you can polish it to your heart's content, wasting precious little time. And even less paper.

You can get VIEW products from your Acorn dealer. Just phone 01-200 0200 for your local stockist.

Alternatively, you can send off for the View Family brochure and order through the post by contacting Acornsoft, c/o Vector Marketing, Denington Industrial Estate, Wellingborough, Northants NN8 2RL. Tel: 0933 79300.

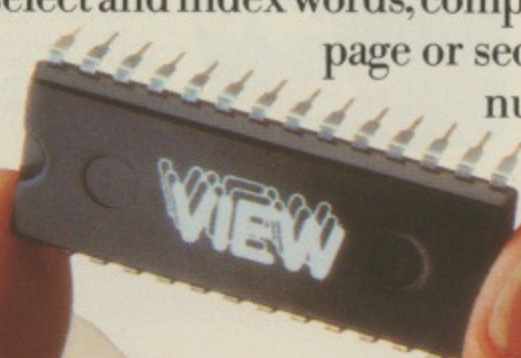
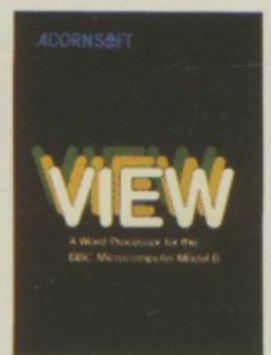
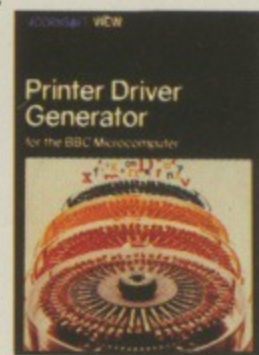

ACORNSOFT

The text on the screen is in Mode 6.

You bought a computer to cultivate your child's mind.

Make sure it's bearing fruit, not growing vegetables.

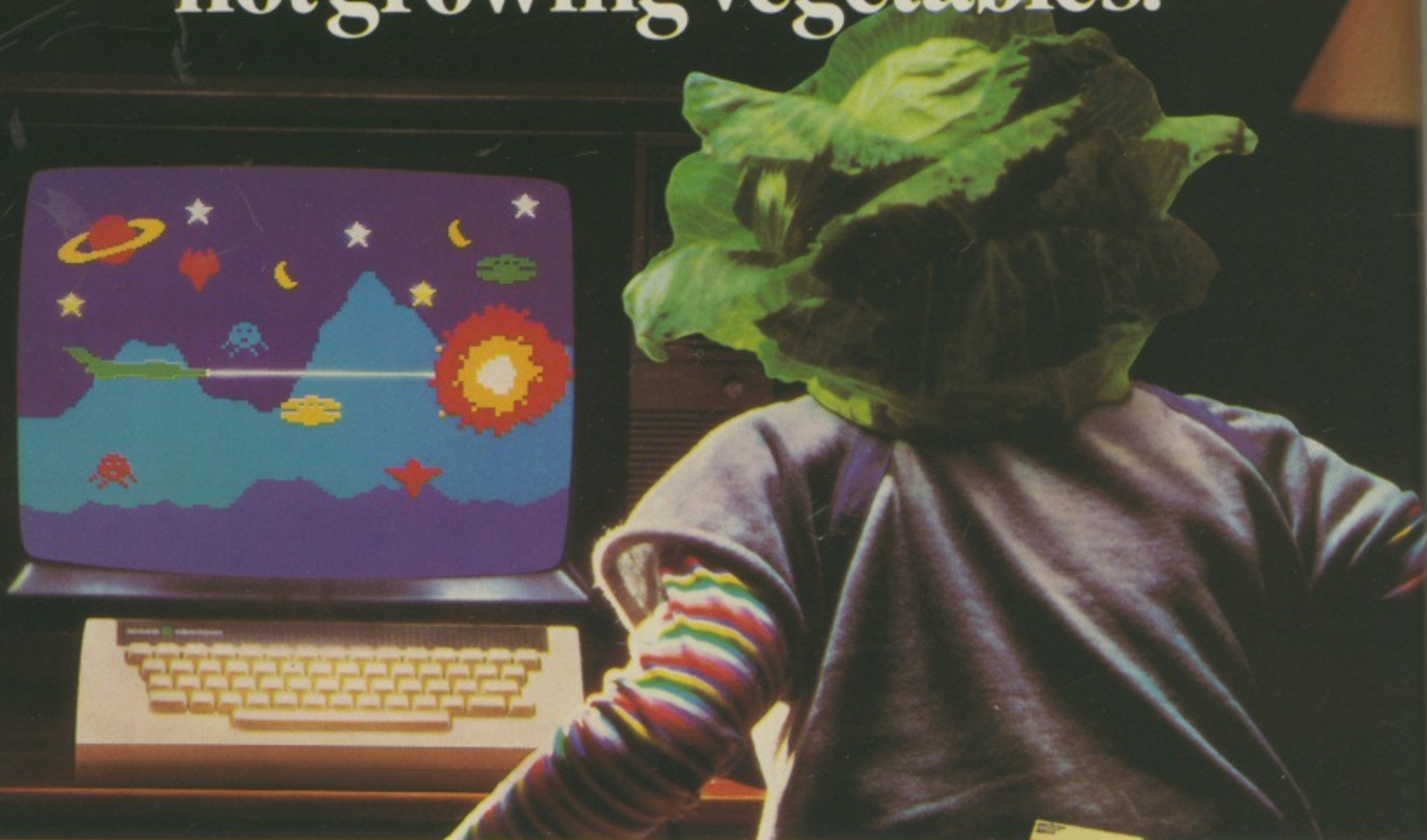

When it comes to developing a child's learning skills the computer's potential is endless.

Unfortunately, the search for software that makes the most of that potential has been endless too.

That is until Spinnaker created their remarkable Learning Tree Series, a unique software range that introduces the one thing missing from most educational programs - fun!

At Spinnaker educators and games programmers write our software.

It's a team effort that uses the understanding of how a child learns in a 'fun' way that makes children simply forget they're learning at all.

So successful is the Spinnaker formula that worldwide more parents buy more Spinnaker programs than any other home educational software.

And now, here in Britain, Spinnaker comes to the rescue of parents saddened by the mindless 'shoot to kill' software syllabus.

If you're looking for software that truly cultivates young minds look out for Spinnaker Learning Tree Series.

We're proud to say Spinnaker is one software house actually giving computer games a good name.



KINDERCOMP

is a collection of six fun learning games that help young children improve their reading readiness and counting skills, as well as familiarising them with the keyboard.



MAKE-A-FACE

is a fun way for children to become comfortable with computer fundamentals such as menus, cursors, the return key, the space bar, simple programs, and graphics and helps improve a child's memory and concentration.



KIDS ON KEYS

Three exciting games that familiarise children with the computer keyboard as they learn to identify numbers, letters and words, and associate them with images they see on the screen.

Available from selected W.H. Smith, Claude Gill, Blackwells and all good software outlets. Most Spinnaker software is available for Commodore 64, Sinclair Spectrum 48K, Acorn Electron and BBC-B micros.

For further information contact Susan Hough,
W.H.S. Distributors, St. John's House, East Street, Leicester LE1 6NE Telephone: (0533) 551196.

SPINNAKER™

We make learning fun.

MIKE COOK'S PROBLEM PAGE



I RECENTLY acquired a Quickshot II joystick for my Beeb. To save money I decided to build the interface printed in the May 1983 issue of your brilliant magazine.

All went well until I tried to use the auto fire feature found on Quickshot II joysticks.

When it was engaged – by sliding a switch – there was an initial signal given out but afterwards all firing ceased.

I checked the circuit thoroughly and found no faults.

There also seems to be nothing wrong with the auto fire circuit on the joystick which I checked on a friend's interface.

Can you advise me so that I can regain use of the auto fire. – *I. Butt, Maidenhead, Berks.*

● My interface circuit was not designed to produce a continuous firing. It sounds like the "quick shot" joystick does this in the interface.

I really think it is cheating, but if you must, here is a circuit that will give you a rapid fire capacity.

It is a multivibrator circuit with values adjusted to give a short "press" of the fire button.

The mark-space ratio (the on to off time) can be altered simply by changing the ratio of the capacitors and resistors R1, R2.

The speed of firing can be altered by changing their

Help me get my auto fire back!

absolute value. The components shown will give about five shots per second.

I have not tried it as I really think it is unfair on the poor aliens, but it should work.

Lost the video knack

AS well as a BBC Micro enthusiast I also tamper with home video movies – I find the BBC excellent for making the opening titles to my videos.

Although I have once successfully managed to record the results from my micro onto video tape, I cannot repeat the performance.

Originally I used the "RF out" lead from the BBC B into the "RF in" of the video, and by playing around with the "RF adjustment", I somehow man-

aged to make the recording.

I now seem to have lost the knack – could you suggest anything? What channel does the BBC B transmit at? Maybe that will help.

I have also toyed with the video terminal of the BBC B but could only achieve black and white results, not very satisfactory. – *J.L. Kirkby, Leeds.*

● The BBC Micro outputs its RF at approximately channel 33. This can be adjusted by turning the slug accessed through the hole in the top of the UHF modulator.

By using this it may be "pulled" slightly. See page 103 of the September 1984 issue of *The Micro User* for full details of how to get colour from the video socket.

Making the connection

IS it possible to connect to *The Micro User* bulletin board using an acoustic coupler working on frequency shift keyed modulation and V24?

If not, why not? And if so what amendments are required to your program in the Beeb Body Building Course, July 84 issue of *The Micro User*. – *R. Hare, Arnold, Nottingham.*

● I am not sure what you mean.

The modem was designed to work with the bulletin board and was tested on it. It uses V21 standard, V24 is not available using this modem chip and V24 is not frequency shift keying standard, but a voltage standard like RS232.

Price poser

I HAVE recently read your "Build Your Own Modem" feature in *The July 1984 issue of The Micro User* where you say the AM7910 modem chip is available for £32 in one-off quantities.

Can you please tell me where it is possible to get it for this price as the best price I can find is £44.95 from Maplin?

Could you also include in a future issue details of other bulletin boards and databases accessible to the general public? – *M.J. Oldfield, Axbridge, Somerset.*

● The price I quoted was a one-off trade price and excluded VAT. You will have to persuade a dealer to sell you one.

A black situation

LESS than two years ago I bought a BBC Model A micro. About 15 months ago I had it upgraded to full Model B status

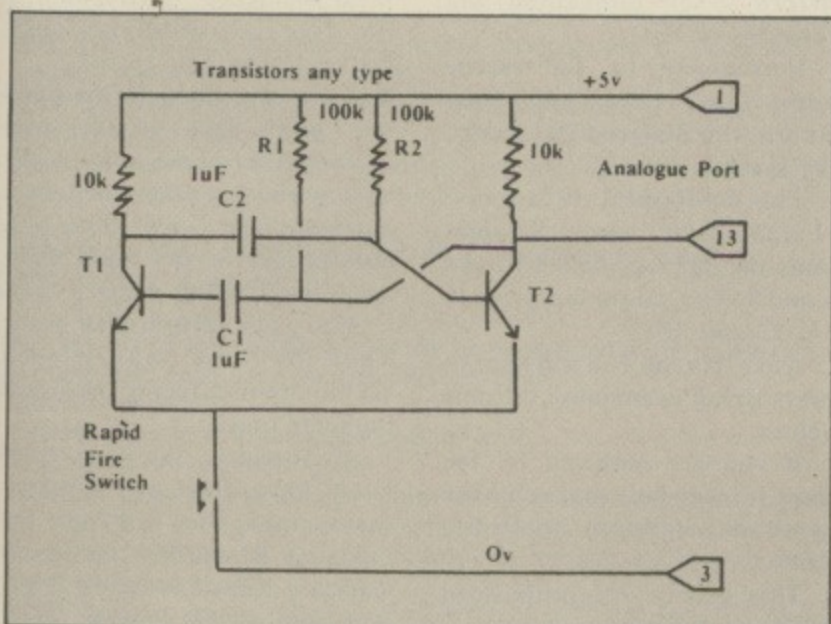

You've got a problem with your micro and you just can't sort it out on your own? Then write to MIKE COOK. If he can't help then probably no one can . .

IF you have a technical query for this page, send it to Mike Cook, *The Micro User*, Europa House, 68 Chester Road, Hazel Grove, Stockport SK7 5NY.

Letters on other subjects should be sent, as usual, to Micromail, which this month starts on Page 191.

From Page 71

by a competent electronics engineer.

The micro has a 0.10 ROM OS and an issue two PCB.

Recently, it has begun to malfunction. From time to time, it simply stops accepting any keyboard input, and the Break key is the only one which functions.

This trouble sometimes clears up after a short time, sometimes not.

The micro has been sent to a repair workshop three times. While in the workshop, the machine has always functioned perfectly.

On its latest visit the VIA chip was replaced. However, this has had no effect on the problem.

I would be very grateful if you could suggest a solution to this annoying problem. — *T.W. Johnston, Banbridge, Co. Down.*

● As your micro is a very old type, it probably has the black power supply. These could not deliver the same amount of power as the newer ones and also run hotter.

I suspect your problem is one of overheating and that in the workshop it is run with the lid off in readiness for the fault.

Perhaps the workshop is cooler than your house?

You could have a new power supply fitted or ensure that there is more ventilation.

Dragon disc on a BBC?

BEFORE I owned a BBC B Micro, I had a Dragon 32 with a Dragon Data disc drive.

Will this disc drive work with my BBC if I fit the disc interface kit?

If not, are there any modifications that will enable it to work? My knowledge of electronics is nil. — *C. Walters, Stokenchurch, Bucks.*

● As far as I know there should be no problem in doing this. Remember you will need to make a new lead to cope with the sockets on the BBC Micro.

A 'dumb' response

HAVING typed in your program to make the Beeb a "dumb" terminal I tried it — but sadly to no avail.

I have a Prism modem 1000 and, like many other people, I would like to get more out of it so I thought if I adjust the baud receive and send rates I could talk to Prestel using your program to have some fun.

As soon as I ran it I found some things about duplex, even and odd bits and stop bits of

which I did not understand. I investigated your article still further and found that there was no relevant information — in my view probably not very accurate — about these points. Hence my letter.

I would be very grateful if you could send me some information about standards etc, plus any further reading you could suggest as I am confident in machine code and feel that with relevant information I too could begin to "hack" at home (fat chance you say). — *Liam Magee, Bryanston, Dorset.*

● Prestel uses 1200 baud to send data and 75 baud to receive data from you. The tone standards are V23 and are different from those used on other bulletin boards.

In addition Prestel uses seven data bits and even parity. Having set your micro to do that, you must then convert the codes characters you receive into the correct codes to drive the BBC Micro in Mode 7.

Although this is nearly similar there are many differences, especially in the way graphics are sent. Also double height characters are sent in a different manner to that required by Mode 7.

To confuse matters even more there is a problem with scrolling and wraparound. All in all, the software conversion is not trivial.

You can get the "spec sheets"

from BT but they will charge you about £25. Alternatively there have been some articles in back issues of *Wireless World*. A lot of libraries stock them but you have to ask.

Are they corrupted?

IT'S loading problems again — the tapes causing trouble are: □ Bug-Byte — *Galaxy Wars*, which was OK until a month ago. Now I'm getting ?* etc. Block 7 etc. I wrote to Bug-Byte but correspondence returned marked gone away. They were in Liverpool, have they gone out of business?

□ Bit Twiddlers' Killa upgrade — they kindly replaced my tape with one "recorded at a higher level" but they did say my tape was OK.

□ Welcome tape is not stopping at each program but just rolling on.

I've cleaned the tape recorder etc (not demagnetised the head) and now many other commercial games are happy.

Interestingly a friend's back up tapes sometimes load and sometimes don't.

I think it must be the entry port on the Beeb, or my Benkson tape recorder — both only one year old — as I cannot really understand how the tapes have become corrupted and I have replaced the cable connecting the tape recorder/micro.

Any ideas please — before the machine goes to a repairer for a week or so and with no guarantee he will solve the problem. — *John Chambers, West Bridgford, Nottingham.* PS. *OPT2.0 sometimes helps me load programs as well.

● Tapes that used to load and now don't have usually been corrupted in some way. They could have been stored near a magnetic field — like close to a loudspeaker — or could have been damaged by dust.

Also your record head could have become magnetised slightly, thus reducing the signal on some tapes.

Alternatively the tape head could have gone out of alignment since you first got the tapes. It is unlikely that your leads are at fault as the trouble is only with certain tapes.

A matter of lost nerve...

A FEW months ago I bought a Pace 100k single disc drive, and inside is a TEC FB501.

It has performed well except for one thing — it is incredibly noisy.

I understand that some disc drives are noisy because of the stepper motor used, but the rattle on this one is the worst I've come across.

When I phoned Pace about the problem, they said matters could be improved by changing some of the option links on the keyboard, namely making links 3 and 4.

The drive would then operate faster and the noise would be lessened — or just different.

So I duly obtained the necessary DIL switch, plugged in the soldering iron and got

inside my Beeb.

Then I realised how horribly close the tracks were!

I lost my nerve as I have neither the necessary fine soldering iron nor the experience to risk it.

My question is this — is there some means via software to simulate the different link settings and hence test out whether this operation would in any case be worth it?

From the point of view of speed it is largely irrelevant, but the noise problem gets on my nerves. — *John Tissandier, Tiverton, Devon.*

● Shame on you losing your nerve — the connectors are miles apart! You should see some real miniaturisation if you are scared of that. However, you could be

trying to solder with a poker. If so, get a decent iron.

The April 1983 issue of *The Micro User* contained my thoughts on that.

Fortunately to the rescue come those clever lads from Acorn who designed the operating system.

The command to try is: *FX255,X,207 where X represents the number made by links 5 and 4. The values to try are 0, 16, 32 and 48.

After this call you will have to press Break to initialise the new values.

If you are bothered by the noise it is obvious that you have never sat next to an Apple disc drive.

They get my vote for the most noisy discs of all.

BANISH KEYBOARD HEADACHES FOR EVER

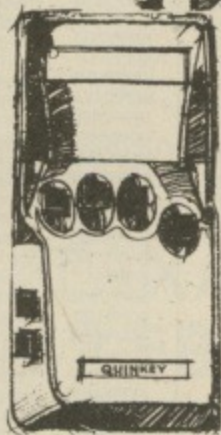

with
QUINKEY
- for just £49.95

LEARN TO USE QUINKEY WITH NO OBLIGATION!

Send for Quinkey now, and you should be touch-typing in less than an hour. Before you know it, you'll be typing much faster than you write.

So confident are we of our claim that we'll give you a no fuss money back guarantee. If you're not happy - FOR ANY REASON - you can simply send it back within 14 days for a full and prompt refund.

KEYBOARD DATA

Quinkey has five main keys which are pressed in combinations. Signals are sent on release of keys. With the addition of the control key Quinkey takes over all inputs except "break" from the BBC keyboard or can be used in conjunction.

Quinkey casing is made from sturdy FR ABS. Professional quality keys and gold cross point microswitches will give heavy-duty performance.

SOFTWARE DATA

When invoked using CHAIN "WP" or CHAIN "PROG", loads at the current PAGE value and moves PAGE up by 768 bytes. No zero-page locations required. Interrupt service vector IRQ2V, correctly chained. PROG may be incorporated into users' programs without difficulty.

INTERFACE DATA

Quinkey's interface to the analogue port of the BBC is a four-channel connector which allows up to four Quinkeys to be used simultaneously with one micro. (For further information about the Educational Pack of four Quinkeys and schools software, tick the appropriate box in coupon)

TESTED COMPATIBILITY

BBC model "B" OS 1.2 BASIC I or BASIC II (unless using INKEY with negative argument), DFS 0.90. View A1.4, Wordwise 1-17, Edword.

FOR COMPREHENSIVE REVIEW OF QUINKEY SEE ACORN USER, SEPT '84

Send the coupon now to take advantage of our special money-back guarantee!

Microwriter Ltd, 31 Southampton Row
London WC1B 5HJ Tel: 01-831 6801

microwriter
QUINKEY To: Microwriter Ltd., 31 Southampton Row,
London WC1B 5HJ

I would like to take advantage of your special money-back guarantee and realise that I can return the pack(s) undamaged within two weeks of delivery if I am not fully satisfied for a complete refund.

Please send:Quinkey pack(s) @ £49.95 (plus £2.50 p&p) £.....
.....More information about the educational pack of 4 Quinkeys and software for schools.

I enclose a cheque made payable to: "Vector Marketing/Microwriter Ltd." for £..... or debit my Visa/Access credit card No.....

Signed.....

Name.....

Address.....

Please allow up to 28 days for delivery. Reg. no. 137 4069

MU11

THE REMEDY FOR "MICRO FATIGUE" - THE ONLY ALTERNATIVE FOR SERIOUS BBC USERS.

Having to face keying a lengthy piece of data is pretty daunting, but that's nothing compared to how you feel when you're only about a quarter the way in.

It's about then that eyestrain and headache combine to make you feel like the many-headed hydra, and the ache in your back makes you envy a packhorse.

And it's all because you're forced to "hunt and peck" amongst 74 keys on a keyboard that's over a hundred years old. Eyes torn between document and keyboard, up to the screen and back to the document - it's no wonder you're losing your place and errors and bugs start creeping in.

QUINKEY PUTS THE PLEASURE BACK INTO USING YOUR COMPUTER

- Quinkey is a keyboard which you simply plug into the analogue port of your BBC computer.
- You can be touch-typing in less than ONE hour. Quinkey uses the technique of Microwriting - practised by thousands of professionals in their working lives.
- Quinkey is operated with only one hand and comes with a long lead, so you can sit back and relax.
- Because you don't need to look at the keyboard - "hunt and peck" - your eyes are free to read data, either from screen or document - accuracy and speed become simple.
- With Quinkey there's no need to lose your place either - your other hand is free to follow data.
- Whether your work is with words or programs, Quinkey is a must. It can even double as a fast and accurate keypad for mass numeric data.

YOU'LL BE AMAZED AT WHAT YOU GET FOR £49.95

Quinkey is sold as a complete package ready to be used right away with your computer. Each pack for the BBC contains:

- Quinkey keyboard
 - Interface and lead to analogue port of BBC
 - Easy to follow self-teach guide
 - "PROG" software (a utility program which interprets Quinkey signals to the BBC and gives you a comprehensive alternative/additional keyboard - all inputs except "Break". It merges easily with your application programs)
- "WP" enables you to fully use software such as "Wordwise", "View" and "Edword" for fast and accurate word-processing.

Electronequip

(Authorised BBC Micro Dealer, and Econet service centre)

NEW View Printer Driver

For FX-80, Juki Brother HR15 and Kaga/Taxan 40/80T Disc
£9.95 inc. VAT

BBC Cassette Software	Exc VAT	Inc VAT
BCAAFRAK Aardvark Frak (Caveman game)	7.00	8.05
BCAAZALA Aardvark Zalaga	7.00	8.05
BCADFOOT Addictive Football Manager	5.87	6.75
BCAFBOUN A & F Software Bouncer	5.92	6.80
BCAFCHIC A & F Software Chuckie Egg	5.84	6.72
BCAFCYLO A & F Software Cylon Attack	5.84	6.72
BCAFFROG A & F Software Frogger	5.92	6.80
BCAFFPAIN A & F Software Painter	5.92	6.80
BCAFSHRI A & F Software Shrinking Professor	5.92	6.80
BCAIAVDE Adventure International Adventureland	7.35	8.46
BCAIPIRA Adventure International Pirate Adventure	7.35	8.46
BCAISECR Adventure International Secret Mission	7.35	8.46
BCAIVOOD Adventure International Voodoo Castle	7.35	8.46
BCAKCHIL ASK Children from Space (XBE16)	7.35	8.46
BCAKCRAN ASK Cranky (XBE17)	7.35	8.46
BCAKFACE ASK Facemaker (XBE10)	7.35	8.46
BCAKHIDE ASK Hide & Seek (XBE11)	7.35	8.46
BCAKLETS ASK Let's Count (XBE12)	7.35	8.46
BCAKNUMC ASK Number Chaser (XBE15)	7.35	8.46
BCAKNUMG ASK Number Gusher (XBR13)	5.82	6.70
BCAKNUMP ASK Number Puzzle (XBE14)	7.35	8.46
BCAKWORD ASK Words, Words, Words (XBE19)	7.35	8.46
BCALBUGB Alligata Software Bug Blaster	5.88	6.76
BCALCOSM Alligata Software Cosmic Asteroids	4.39	5.05
BCALDAMB Alligata Software Dambusters	5.87	6.75
BCALEAGL Alligata Software Eagle Empire	5.87	6.75
BCALFRUI Alligata Software Fruit Machine (B006)	4.39	5.05
BCALUNCL Alligata Software Uncle Claude	7.00	8.05
BCAMALGE Ampalsoft Cheshire Cat Algebra D level	5.13	5.90
BCAMARIT Ampalsoft Cheshire Cat Arithmetic D level	5.13	5.90
BCAMCALC Ampalsoft Cheshire Cat Calculus D level	5.13	5.90
BCAMCONS Ampalsoft Cheshire Cat Construction '0'	5.13	5.90
BCAMGRAP Ampalsoft Cheshire Cat Graphs D level	5.13	5.90
BCAMTRIG Ampalsoft Cheshire Cat Trigonometry '0'	5.13	5.90
BCAS100P Acornsoft 100 Programs for BBC Micro	8.50	9.78
BCASAACT Acornsoft Arcade Action (SBG06)	8.80	10.12
BCASARCA Acornsoft Arcadians (SBG14)	7.35	8.46
BCASAVIA Acornsoft Aviator flight simulator SBG02	11.05	12.71
BCASBUSI Acornsoft Business Games (SBE03)	7.35	8.46
BCASCARD Acornsoft Carousel (SBG24)	7.35	8.46
BCASCASD Acornsoft Castle of Riddles (SBG17)	7.35	8.46
BCASCHAN Acornsoft Chemical Analysis (SBE12)	10.20	11.73
BCASCHES Acornsoft Chess (SBG10)	7.35	8.46
BCASCHSI Acornsoft Chemical Simulations (SBE13)	10.20	11.73
BCASCHST Acornsoft Chemical Structures (SBE14)	10.20	11.73
BCASCOLL Acornsoft/ICL Collectors Cat. SBX05	7.35	8.46
BCASCOUN Acornsoft Countdown to Doom (SBG19)	7.35	8.46
BCASCRAZ Acornsoft Crazy Tracer (SBG26) (B)	7.35	8.46
BCASCREA Acornsoft Creative Graphics (SBX01)	7.35	8.46
BCASDESK Acornsoft Desk Diary (SBB01)	7.35	8.46
BCASDRAU Acornsoft Draughts & Reversi (B) (SBG20)	7.35	8.46
BCASDROG Acornsoft Drogna (SBG27)	7.78	8.95
BCASELIT Acornsoft Elite (SBG38)	12.35	14.20
BCASEXAM Acornsoft Examiner Cassette (SBE17) (B)	7.35	8.46
BCASFORE Acornsoft Forecast (SBB02)	8.80	10.12
BCASFORT Acornsoft Forth Cassette (SBL01)	12.45	14.32
BCASFREE Acornsoft Free Fall (SBG28)	7.35	8.46
BCASFREN Acornsoft French (Linkword) (SBX13)	11.05	12.71
BCASGERM Acornsoft German (Linkword) (SBX16)	11.05	12.71
BCASGRAD Acornsoft Graphics on the BBC	8.50	9.78
BCASGRAP Acornsoft Graphs & Charts (SBX02)	7.35	8.46
BCASHOOK A'soft/ICL Hooked on Numbers (SBX08)	7.35	8.46
BCASHOPP Acornsoft Hopper (SBG23)	7.35	8.46
BCASITAL Acornsoft Italian (Linkword) (SBX14)	11.05	12.71
BCASJARS Acornsoft Jars (SBE15)	8.83	10.16
BCASJCB0 Acornsoft JCB Digger (SBG09)	7.35	8.46
BCASKING Acornsoft Kingdom of Hamil (SBG25)	7.35	8.46
BCASLISD Acornsoft Lisp Demo Progs SBL09	7.35	8.46
BCASLISP Acornsoft Lisp Cassette (SBL02)	12.45	14.32
BCASMAGI Acornsoft Magic Garden (B) (SBX04)	7.35	8.46
BCASMEMB Acornsoft/ICL M'ship Manager (SBX06)	7.35	8.46
BCASMETE Acornsoft Meteors (SBG13)	7.35	8.46
BCASMETM Acornsoft Meteor Mission (SBG29)	7.78	8.95
BCASMICR Acornsoft Microtext (SBL04)	36.85	42.37
BCASMISB Acornsoft Missile Base (SBG18)	7.35	8.46
BCASMISV Acornsoft Missing Signs (SBE09)	8.83	10.16
BCASMONS Acornsoft Monsters (SBG03)	7.35	8.46

BBC Cassette Software	Exc VAT	Inc VAT
BCASNUMB Acornsoft Number Balance (SBE08)	8.83	10.16
BCASNET Acornsoft/ICL One to Nine (SBX07)	7.35	8.46
BCASPEEK Acornsoft Peeko-Computer Pack (SBE02)	7.35	8.46
BCASPERS Acornsoft Personal Money M'ment SBB5	8.80	10.12
BCASPHIL Acornsoft Philosophers Quest (SBG01)	7.35	8.46
BCASPICT Acornsoft Picture Maker (SBX03)	7.35	8.46
BCASPLAN Acornsoft Planetoid (Defender) (SBG15)	7.35	8.46
BCASROCK Acornsoft Rocket Raid (SBG05)	7.35	8.46
BCASSENT Acornsoft Sentence Sequencing (SBE07)	8.83	10.16
BCASSINV Acornsoft Super Invaders (SBG16)	7.35	8.46
BCASSLID Acornsoft Sliding block puzzles (SBG12)	7.35	8.46
BCASSNAP Acornsoft Snapper (SBG04)	7.35	8.46
BCASSNOO Acornsoft Snooker (SBG21)	7.35	8.46
BCASSPAN Acornsoft Spanish (Linkword) (SBX15)	11.05	12.71
BCASSPAS Acornsoft S Pascal (SBL08)	12.45	14.32
BCASSPHI Acornsoft Sphinx Adventure (SBG07)	7.35	8.46
BCASSTAR Acornsoft Starship Command (SBG22)	7.35	8.46
BCASTETR Acornsoft Tetrapod (SBG32)	7.78	8.95
BCASTREE Acornsoft Tree of Knowledge (SBE04)	7.35	8.46
BCASTURT Acornsoft Turtle Graphics (SBL07)	12.45	14.32
BCASVIEW Acornsoft View Printer Driver (SBB04)	7.35	8.46
BCASVOLC Acornsoft Volcano (SBG33)	7.78	8.95
BCASWORH Acornsoft Word Hunt (SBE05)	8.83	10.16
BCASWORS Acornsoft Word Sequencing (SBE06)	8.83	10.16
BCBEAVM BES Animal Vegetable Mineral (XBE03)	6.63	7.62
BCBEHAPL BES Happy Letters (XBE07)	6.63	7.62
BCBEHAPN BES Happy Numbers (XBE04)	6.63	7.62
BCBEMAPR BES Map Rally (XBE08)	6.63	7.62
BCBETIM1 BES Timeman One (XBE05)	6.63	7.62
BCBETIM2 BES Timeman Two (XBE06)	6.63	7.62
BCBEWORH BES Wordhang (XBE02)	6.63	7.62
BCBEWORW BES World-Wise (XBE01)	6.63	7.62
BCBSBEYO BBCsoft Beyond Basic Cassette (B)	8.50	9.78
BCBSBANY BBCsoft Canyon (B)	7.39	8.50
BCBSDRAW BBCsoft Drawing	7.40	8.50
BCBSDRWH BBCsoft Dr Who. The First Adventure (B)	7.39	8.50
BCBSSEARL BBCsoft Early Learning	7.40	8.50
BCBSFUNG BBCsoft Fun Games	7.40	8.50
BCBSGAMS BBCsoft Games of Strategy	7.40	8.50
BCBSHOMF BBCsoft Home Finance	7.40	8.50
BCBSMAKM Making the most of your Micro (Inc book)	9.57	11.01
BCBSMOTO BBCsoft Motorists' Log	7.40	8.50
BCBSPAIN BBCsoft Painting	7.40	8.50
BCBSPRD1 BBCsoft Programs Vol 1	7.40	8.50
BCBSPRD2 BBCsoft Programs Vol 2	7.40	8.50
BCBSRECO BBCsoft Record Keeper (B)	10.20	11.73
BCBSTAXC BBCsoft Taxcalc (B)	8.16	9.38
BCBSTOOL BBCsoft Tool Box (B)	15.52	17.85
BCBSVUTY BBCsoft VU Type (Typing Tutor) (B)	11.90	13.69
BCBSWHIT BBCsoft White Knight Mark Eleven (B)	8.50	9.78
BCBUTWIN Bug-Byte Twin Kingdom Valley	7.02	8.07
BCCCANDR Computer Concepts Android Attack	6.61	7.60
BCCCASTE Computer Concepts Asteroid belt	5.87	6.75
BCCCCHES Computer Concepts Chess	6.61	7.60
BCCCLOGO Computer Concepts Logo II	8.50	9.78
BCCCSNAK Computer Concepts Snake	5.87	6.75
BCCCSPAC Computer Concepts Spacehawks	5.87	6.75
BCCCSWAR Computer Concepts Swarm	6.61	7.60
BCDS747 Doctor Soft 747	5.87	6.75
BCGEBEEB Gemini BeebeCalc (Spreadsheet)	14.75	16.96
BCGEBEEP Gemini Beebplot (Graph Plot)	14.75	16.96
BCGECATE Gemini Caterpillar	7.35	8.46
BCGGFAIR Griffin & George Fairshare	7.35	8.46
BCGGGETS Griffin & George Getset	7.35	8.46
BCGGNUMB Griffin & George Numberfun	7.35	8.46
BCGGTABL Griffin & George Tablesums	7.35	8.46
BCGGWORG Griffin & George Wordgames	7.35	8.46
BCGGWORS Griffin & George Wordspell	7.35	8.46
BCGHTALP Good Houseke'g Mr T's Alphabet	9.57	11.01
BCGHTMEA Good Houseke'g Mr T's Measuring Games	9.57	11.01
BCGHTMON Good Houseke'g Mr T's Money Box	9.57	11.01
BCGHTNUM Good Houseke'g Mr T's Number Games	9.57	11.01
BCGHTSHA Good Houseke'g Mr T's Shape Game	9.57	11.01
BCGHTTEL Good Houseke'g Mr T Tells the Time	9.57	11.01
BCHOADVB Honeyfold Advanced Basic course	12.10	12.71
BCHOBEGA Honeyfold Beginners Assembly Language	12.10	12.71
BCHOBEGB Honeyfold Beginners Basic course	12.10	12.71
BCIBCRIM Ivan Berg Crime & Detection Quiz (XBX02)	9.35	10.75
BCIBDATI Ivan Berg Dating Game (XBX08)	9.35	10.75
BCIBHIST Ivan Berg History Quiz (XBX04)	9.35	10.75
BCIBIDO Ivan Berg 'I Do' (XBX07)	9.35	10.75
BCIBMUSI Ivan Berg Music Quiz (XBX03)	9.35	10.75
BCIBROYA Ivan Berg Royalty Quiz (XBX06)	9.35	10.75
BCIBSCIE Ivan Berg Science Fiction Quiz (XBX05)	9.35	10.75
BCIBTHER Ivan Berg Theatre Quiz (XBX01)	9.35	10.75
BCIJHYPE IJK Hyperdrive for BBC (13)	4.80	5.52
BCIJINVA IJK Invaders for BBC (9)	5.54	6.37
BCIJSTRA IJK Stratobomber for BBC (14)	5.54	6.37
BCIJSUPE IJK Super Hangman	3.32	3.82
BCJOYSTI Joystick Utility program for BBC	5.06	5.82
BCKAGALA Kansas Galactic Firebird	7.01	8.06
BCKDFREA Kosmos Software French Mistress A	7.35	8.46
BCKDFREB Kosmos Software French Mistress B	7.35	8.46
BCKOGERA Kosmos Software German Master A	7.35	8.46
BCKOGERB Kosmos Software German Master B	7.35	8.46
BCKOSPAA Kosmos Software Spanish Tutor A	7.35	8.46
BCKOSPAB Kosmos Software Spanish Tutor B	7.35	8.46
BCL9COLO Level 9 Colossal Adventure (B)	7.32	8.42
BCL9DUNG Level 9 Dungeons (B)	7.32	8.42

BBC Cassette Software	Exc VAT	Inc VAT
BCL9LORD Level 9 Lords of Time (b)	7.32	8.42
BCL9SNOW Level 9 Snowball (b)	7.32	8.42
BCMHHOBB Melbourne House Hobbit	11.05	12.71
BCMSOUIB Mirrorsoft Quick Thinking (B)	5.13	5.90
BCOCMRWI Ocean Mr. Wimpy	5.10	5.87
BCPPAFORT Pace Software Fortress	6.61	7.60
BCPPADVE Program Power Adventure (B)	5.87	6.75
BCPPALID Program Power Alien Destroyers (Invader)	5.91	6.78
BCPPALIE Program Power Alien Swirl	5.13	5.90
BCPPASTE Program Power Asteroid Storm (B)	5.87	6.75
BCPPASTR Program Power Astro Navigator	4.21	4.98
BCPPBAND Program Power Bandits at 3 o'clock	5.14	5.91
BCPPBARR Program Power Barrage for BBC	5.13	5.90
BCPPBEEB Program Power Beeb-Tote (B)	4.40	5.17
BCPPBUMB Program Power Bumble Bee (B)	5.87	6.75
BCPPCAVA Program Power Caveman Adventure	5.06	5.83
BCPPCHEM Program Power Chemistry	5.13	5.90
BCPPCHES Program Power Chess	5.87	6.75
BCPPCOSM Program Power Cosmic Combat (B)	5.14	5.91
BCPPCOWB Program Power Cowboy Shoot-out	5.06	5.83
BCPPCROA Program Power Croaker	5.87	6.75
BCPPCYBE Program Power Cybertron Mission (B)	5.87	6.75
BCPPDANG Program Power Danger! UXB	5.87	6.75
BCPPDEMO Program Power Demon Decorator (Painter)	5.06	5.83
BCPPDIS Program Power BBC Disassembler	5.13	5.90
BCPPDUNE Program Power Dune Rider	6.22	7.10
BCPPELDO Program Power Eldorado Gold (Adventure)	5.06	5.83
BCPPESCA Program Power Escape from M'base Alpha	5.87	6.75
BCPPFFAC Program Power Felix in the Factory	5.87	6.75
BCPPFFRU Program Power Felix & the Fruit Monsters	5.87	6.75
BCPPFHOU Program Power Fhoulis	5.87	6.75
BCPPHELL Program Power Hell Driver (B)	5.87	6.75
BCPPINTE Program Power Intergalactic Trader (B)	5.87	6.75
BCPPJETP Program Power Jet Power Jack	5.87	6.75
BCPPKILL Program Power Killer Gorilla	5.87	6.75
BCPPLABC Program Power Labyrinths of la Coshe	5.87	6.75
BCPPPLASE Program Power Laser Command	5.87	6.75
BCPPMART Program Power Martian Attack (B)	5.87	6.75
BCPPMINE Program Power Mine (B)	5.87	6.75
BCPPMOON Program Power Moon Raider	5.87	6.75
BCPPNEME Program Power Nemesis (B)	5.87	6.75
BCPPPHYS Program Power Physics	5.06	5.83
BCPPPOKE Program Power Poker Dice (B)	4.40	5.17
BCPPPOSI Program Power Positron (B)	5.14	5.91
BCPPPREV2 Program Power Reversi (32K)	4.21	4.98
BCPPROUL Program Power Roulette for BBC	4.21	4.98
BCPPSEEK Program Power Seek	5.06	5.83
BCPPSPAC Program Power Space Jailer (B)	5.14	5.91
BCPPSTOC Program Power Stock Car (B)	6.56	7.44
BCPPSWOO Program Power Swoop	5.87	6.75
BCPPTIMT Program Power Timetrek (Star Trek Plus)	5.87	6.75
BCPPWALL Program Power Wall (B)	4.40	5.17
BCPPWHER Program Power Where (B)	5.14	5.91
BCPPWORLD Program Power World Geography (B)	5.14	5.91
BCPPZARM Program Power Zarm (B)	5.87	6.75
BCPSSALO Psion Saloon Sally	4.39	5.16
BSQSBEEB Quicksilva Beeb Art (B)	11.05	12.71
BSQSMUSI Quicksilva Music Processor (B)	11.05	12.71
BSRHGALA RH Software Galactic Wipeout (RHSD01C)	6.61	7.60
BSRHSKIS RH Software Ski Slalom (RHSD02C)	6.61	7.60
BSHGBL Simon W Hessel GB Ltd	5.13	5.90
BSHSHINE Simon W Hessel Interitance	4.39	5.16
BSHSTRAV Simon W Hessel Travel Game	4.39	5.16
BSI3D0B Software Invasion 3D Bomb Alley	5.87	6.75
BSIATTA Software Invasion Attack on Alphacenturi	5.87	6.75
BSIEAGL Software Invasion Eagles Wing (B)	5.87	6.75
BSIGUNS Software Invasion Gunsmoke	5.87	6.75
BSISPOD Software Invasion Spooks & Spiders (B)	5.87	6.75
BSIVORT Software Invasion Vortex	5.87	6.75
BSMSDIS Simonssoft Disassembler	5.87	6.75
BCSS2002 Superior Software 2002	5.87	6.75
BCSSALID Superior Software Alien Dropout	5.87	6.75
BCSSBATT Superior Software Battle Tank	5.87	6.75
BCSSCENT Superior Software Centipede	5.87	6.75
BCSSCOLD Superior Software Colditz Adventure	5.53	6.29
BCSSCRAZ Superior Software Crazy Painter	5.87	6.75
BCSSFAIR Superior Software Fairground	5.87	6.75
BCSSFROG Superior Software Frogger	5.87	6.75
BCSSFRUI Superior Software Fruit Machine	5.87	6.75
BCSSGALA Superior Software Galaxians	5.87	6.75
BCSSHUNC Superior Software Hunchback	5.87	6.75
BCSSINVA Superior Software Invaders	5.87	6.75
BCSSOVER Superior Software Overdrive	5.87	6.75
BCSSPONT Superior Software Pontoon	5.13	5.90
BCSSQBDR Superior Software QBert	5.87	6.75
BCSSROAD Superior Software Road Runner	5.87	6.75
BCSSSPAF Superior Software Space Fighter	5.87	6.75
BCSUJUNW Sulis Software Junior Wordsplits	7.35	8.46
BCSUJUUT Sulis Software Just a Mot	7.35	8.46
BCSUJOPEN Sulis Software Open Sesame	7.35	8.46
BCSUSTAW Sulis Software Starter Wordsplits	7.35	8.46
BCSUTENF Sulis Software Tense French	7.35	8.46
BCSUTIME Sulis Software Time Traveller	7.35	8.46
BCSUWORD Sulis Software Wordpower	7.35	8.46
BCVIDARE Visions Daredevil Dennis	7.00	8.06
BCVIDEMO Visions Demolator	7.00	8.06
BCVIPENG Visions Pengi	7.00	8.06
BCVISNOO Visions Snooker	6.61	7.60
BCVMDLDT Voltmace Delta Driver Cassette	4.39	5.16



Electronequip



Electronequip

(Authorised BBC Micro Dealer, and Econet service centre)

*** SPECIAL OFFERS**
Mail order only

*** EPSON**

FX-80FT £225.25 + VAT

FX-80 £320.88 + VAT

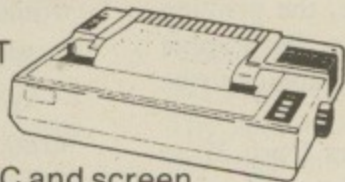

Printer price includes cable for BBC and screen dump rom is available for £11.50

KAGA/TAXAN *
KP810 £242.58 + VAT

VOLTMACE JOYSTICKS
*** 10% off list prices**



Discounted price

JSVOLT 14	Voltmace Delta 14B Joysticks	13.46
JSVOLTAD	Voltmace 14B/1 Adaptor Box	13.36
JSVOLT3B	Voltmace Delta 3B Twin Joysticks	18.09

SIDEWISE

SIDEWISE FITTED

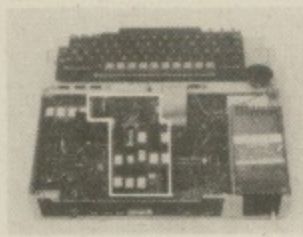
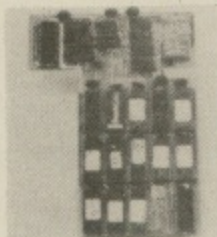

"SIDEWAYS" rom board for BBC Micro.
No soldering required **£36.00 + VAT**

NORDMENDE

14" TV/Monitor
£202.35 + VAT

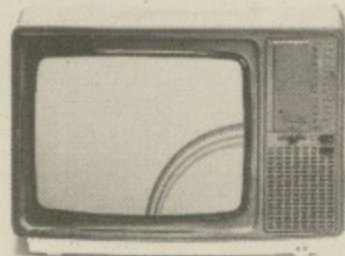

5 FREE ACORNSOFT GAMES
WITH EVERY (while stocks last)
BBC

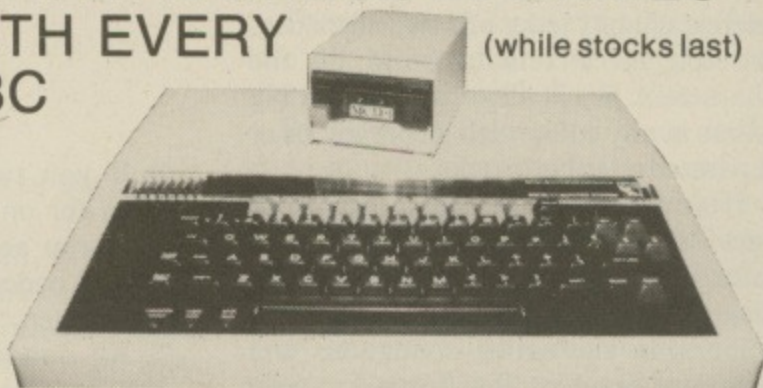

Electronequip is an authorised Acorn service centre and has been an Acorn dealer since the introduction of the Atom. Our demonstration facilities include 20 station Econet and Torchnet systems.

Ref.	BBC Micros	Ex VAT	Inc VAT
ANB01	BBC Model B Micro Computer	348.26	399.00
ANB02	BBC Model B with Econet Interface	389.14	446.00
ANB03	BBC Model B with Disc Interface	409.14	469.00
ANB04	BBC Model B with Disc & Econet Interface	450.01	516.00
ANC01	6502 Second Processor	174.35	199.00
ANC04	Z80 Second Processor	348.26	399.00
ACBBITST	Acorn Bit Stick (ANF04)	327.39	376.50
ACBTELET	Teletext Receiver (ANE01)	195.65	225.00

3" Micro Disc £89.00
(inc. VAT)

Disc Interface & Drive
£181.30 (inc. VAT)

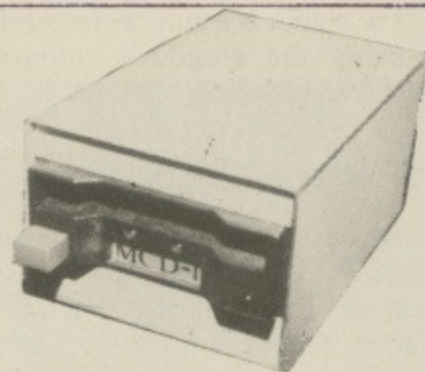

Micro Disc Drive for the BBC Micro

The Micro disc drive offers a method of low cost quick access to programs. The drive is essentially a small version of a 5 1/4" disc drive and offers similar features to the larger drive. The data is stored on a 3" disc, this is enclosed in a protective hard plastic cassette which features a write protect switch. The micro drive requires the standard Acorn disc interface, but a new disc filing system rom. Acorn DFS may be exchanged for the micro DFS for £2.30. The new micro disc filing system can read and write to Acorn DFS discs. Thus if a 5 1/4 inch and a micro floppy were connected on the same cable files could be transferred between them.
Capacity: 80.64 K bytes Transfer Rate: 125k bit/s.

Prices subject to variation without prior notification
Prices for monitors & printers include BBC cable

TRADE ENQUIRIES WELCOME
Access & Barclaycard Accepted
Large Stocks - 24 Hour Despatch Carriage 46p

BRANCHES
MAIL ORDER: 36-38 WEST STREET
FAREHAM, HANTS. (0329) 230670
SHOP/TECHNICAL: 59 WEST STREET
FAREHAM, HANTS. (0329) 230671
KINGS LYNN: 17 TENNYSON AVE. (0553) 3782



Electronequip

36-38 West Street, Fareham, Hants (0329) 230670

IN the May 1984 issue of *The Micro User*, an article appeared on how to produce multi-sized characters in Modes 0 to 6.

Just to be fair to Mode 7, here is a teletext chunky letter printer, which uses the teletext Pixels to build up the characters. It will allow you to print big letters in any colour using contiguous or separated graphic blocks.

If you type in the listing leave out lines 10 to 170 if you feel lazy. The micro will print the letters BBC diagonally across the screen in various colours, in alternating contiguous and separated graphics. It will then do a very quick portrait of me!

The printing itself is instantaneous since direct access is made to the screen and ROM/RAM character definitions.

The procedure is in lines 1620 to 1690 in the listing. It puts various parameters into the memory for the machine code to use, and then calls the code. To call the procedure, the syntax is:

```
PROCPrint(colour ,separation ,X start
Pos ,Y start Pos , "TEXT")
```

The colour is a number between 1 and 7 using the standard colours. The separation parameter should be 0 or 1 - 1 will give separated graphics, 0 will give contiguous graphics.

The X and Y start positions are the standard X, Y positions as found in Mode 7.

Note that printing will start one column to the right of the specified Y coordinate because the micro will insert the correct graphic control code in front of the graphic blocks.

If you select separated graphics, it will start yet one more position to the right so that it can insert a separated graphic character.

The text can be any letter(s) or user defined character(s), but two points must be made.

Choose chunky

Use teletext pixels to build up characters in

□ If you type in more than there is room for on a single line, the printing will wrap around, causing the graphic control codes and other graphics to be overwritten.

□ All standard characters from 32 to 126 can be printed. However, user characters are slightly different. All user defined graphic codes are between 128 and 255, which means that there are a possible 128 graphics.

In practice, if you have not exploded the character set using *FX20 you can only define 32 different blocks, so all the graphics are repeated four times at intervals of 32.

So $\text{CHR}\$(128) = \text{CHR}\$(128+32) = \text{CHR}\$(128+32+32) = \text{CHR}\$(128+32+32+32)$. Because of the way the routine works, you can access all the UDGs but you must use the lowest possible code, which will be between 128 and 159 inclusive.

In lines 1560 to 1580, character 128 is used. If you were in Mode 2 $\text{CHR}\$(128)$, $\text{CHR}\$(160)$, $\text{CHR}\$(192)$ and $\text{CHR}\$(224)$ would all produce a little man, but the teletext print routine will work only with $\text{CHR}\$(128)$.

If you have exploded the character set, the routine can only access $\text{CHR}\$(128)$ to $\text{CHR}\$(159)$.

To clear any confusion, here are two examples:

The format to print 'Hello' starting at (0,4) in separated red would be:

```
PROCPrint(1,1,0,4,"Hello")
```

The format to print 'BBC' and the user defined graphic with code 226

starting at (2,3) in contiguous blue would be:

```
PROCPrint(4,0,2,3,"BBC"+CHR$(130))
```

"BBC"+ $\text{CHR}\$(130)$ will pass a string consisting of the letters B, B, C and the character with code 130. Notice that the code of the UDG was between 128 and 159. ($226-32-32-32=130$).

The procedure does not check that the parameters passed to it are valid. For example it will try using colour 101 if you pass the colour as 101. Checking could be included, but if you are sure that only valid numbers are passed, it would only be a waste of time.

Because the C%, S%, X%, Y%, and M\$ are in the brackets after DEF PROCprint, they will not affect variables of the same name elsewhere in the program. These are called local variables and are described more fully on page 230 of the User Guide.

The routine can calculate the (X,Y) position correctly only if the screen has not been scrolled. Otherwise, it will work, but the text will not appear at the desired (X,Y) position.

To get the machine code into your program you can either type in lines 190 to 1520 into every program that you want big letters - but not necessarily with those line numbers - or you can save the assembled machine code only. You will have to type in lines 190 to 1520 and run.

To save the code type:

```
*SAVE "BIGLETTERS" 900 9CE
```

and to load it back into the program

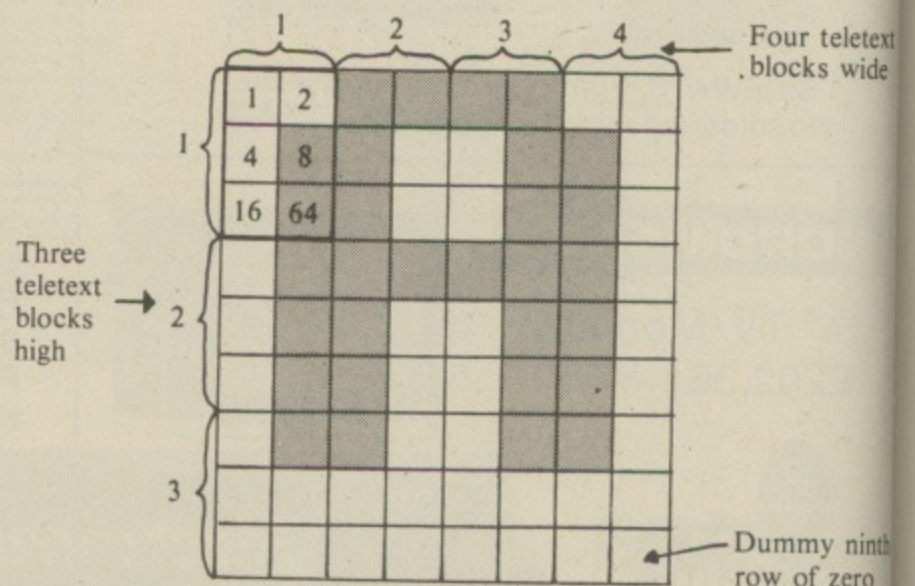
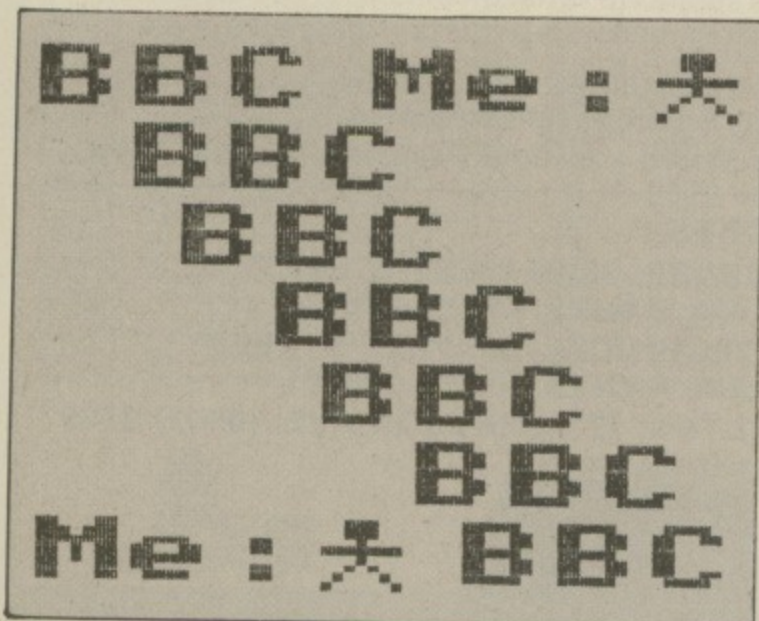

Figure 1: Enlarged teletext 'A'.

ky mode 7 letters

ers in this program by **CHRISTOPHER STOPS**

requiring it type:

***LOAD "BIGLETTERS"**

Note that because of where the code lives, it will be destroyed if cassette filing (not saving and loading) or envelopes with numbers 5 to 15 are used.

Addresses &A00 onwards are used as a text buffer, the text being placed there by line 1670.

Figure I shows how the first teletext block for the letter 'A' is calculated, with the teletext pixel values for that block

also shown (see page 155 of the User Guide).

The first row is shifted left, so the top left pixel will be put into the carry flag. The accumulator is then rotated right, the pixel now being in bit 7 of the accumulator.

This is repeated, the second pixel of the top row now being moved out, and into the accumulator. The second row is then acted upon in the same way.

In the third row, the first bit is

transferred. Now in the teletext pixel values, there is no pixel with value 32, so an extra 0 is shifted into the A register in line 1240. The pixel with value 64 is shifted and rotated next.

Then in line 1270, an extra 0 is shifted into the accumulator again, because there is no pixel with value 128.

By now we have done seven shifts and rotations since the first one, which means the first pixel which had value 1 and was put into bit 7 of the accumulator has now reached the 'units' bit of the accumulator.

In fact they have all reached their correct place. In addition, 160 has to be added to the result (lines 1280 to 1290). Then at line 1300, the teletext pixel is finally put on the screen.

This has to be repeated for four teletext blocks across the character, and for three blocks down.

In the specific case of the first block for 'A' shown above, the accumulator will end up with ones in the eights and sixty-fours columns. Add on the 160, which gives CHR\$(232).

Check it on page 489 of the User Guide.

STRUCTURE

Lines

- 290-450** Calculate at what address on the screen the position (X,Y) is, using the formula $X+40*Y+\&7C00$. The routine does the multiplication by continuous adding of 40 for Y times. Because of the way the loop is constructed, if Y originally contained 0, the loop will not repeat 256 times which is what happens in badly constructed loops. The resulting address is put into locations &81 and &82.
- 460-560** Insert the necessary graphic codes, and increment the screen poking address to allow for the insertion.
- 570-700** Similar to above for separated graphic control codes, if required.
- 710-720** Reset the current letter pointer to the first letter.
- 760-860** Access the current letter. If it is a carriage return, all the letters have been processed and a return to the OS is made.
- 740-750** Set up a constant which will be needed later.
- 790-820** If the character accessed was negative in two's complement, it therefore had a code between 128 and 255, indicating a user defined graphic. The action in this case is to change the constant. The ROM address of the character definition is calculated, from the formula $(ASC '?'-32)*8$, where '?' is any character from CHR\$(32) onwards. To this must be added a constant, because standard characters start at &C000 and UDGs start at &C00. The constant was in fact found earlier, and is now used to calculate the final ROM or RAM address.
- 1020-1070** Copy the eight bytes of the definition into the RAM, where they can then have rotations done on them. Two bits out of three lines of definition are shifted out at a time, so that a complete two across by three down teletext block is computed each time.
- 1140-1270** Do the above. A slight problem occurs because the teletext block graphics which are three pixels high will not exactly divide into the vertical eight pixels of a character definition. This is solved by having a dummy ninth row of definition as zero, inserted at lines 240 to 250.

The above rotations are repeated four times for each triple row of character definition. The triple row handling is repeated three times per character. The whole lot, ROM address calculations and all, is repeated for each letter. Just like nested loops in fact, and the 6502 does it all in split milliseconds!

Teletext listing

```
10 REM *****
20 REM * TELETXT LETTERS *
30 REM * (c) Micro User *
40 REM *****
50 REM
60 REM &70-&71=TEXT ADDRESS
70 REM &72 =CURRENT LETTER
80 REM &73-&74=ROM ADDRESS
90 REM &75-&7C=CHAR DEFINITION

100 REM &7D =ZERO FOR CHAR 9TH R
DW
110 REM &7E =GRAPHICS COLOUR
120 REM &7F =SEPARATED/NOT
130 REM &80 =CURRENT TELETXT BL
OCK
140 REM &81-&82=SCREEN POKEING ADDR
ESS

150 REM &83-&84=STARTING X/Y POS
160 REM &85 =UDG FLAG/ADDER
170 REM
180 MODE 7:VDU23;B202;0;0;0;
190 FOR Q%=0 TO 2 STEP 2
200 PX=&900
```

Turn to Page 177

ChipChat[®]

Modem

ChipChat modems are the most versatile and up to date available at the price. With autoanswer as standard and intelligent autodial with speed conversion as an option, ChipChats may be used to access computers and databases such as Prestel, Micronet, Homelink and BT Gold.

ChipChats support the CCITT V21 protocol: 300/300 baud and the V23 protocol: 1200/75, 75/1200 and 1200/1200 (half duplex). Where local regulations permit, Bell standard operation may be used for dialling US databases.

ChipChats use the latest technology and provide valuable extra features such as auto-disconnect to save your telephone bills, and speed conversion for operation with IBM PCs. A full complement of LEDs monitor data flow and the status of handshake lines on the Cannon D-type connector.

ChipChat modems have been designed with our experience of manufacturing BT approved intelligent terminals, they provide the facilities and data rates you need at the touch of a button or they can be left unattended under computer control.

ChipChats are supported by a large range of communications software packages and terminal emulations for the IBM, Sirius, Apricot, Apple and BBC micros.

Ring for details and special package deal prices.

ChipChat	CC2123A	Autoanswer	£130.35
			£149.90 inc VAT
ChipChat	CC2123AD	Autodial	£165.13
			£189.90 inc VAT
		P & P	£2.70 + VAT

BABT Approval
Applied For

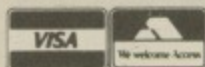

Digisolve
Micro electronic design consultancy.

Digisolve Limited
Aire and Calder Works
Cinder Lane, Castleford, West Yorks WF10 1LU
Tel: 0977 513141/4 Telex 557661 AGRAM G

BIG MT80 PRICE REDUCTION

NOW ONLY £217+VAT

WHY MICROS LOVE MT 80

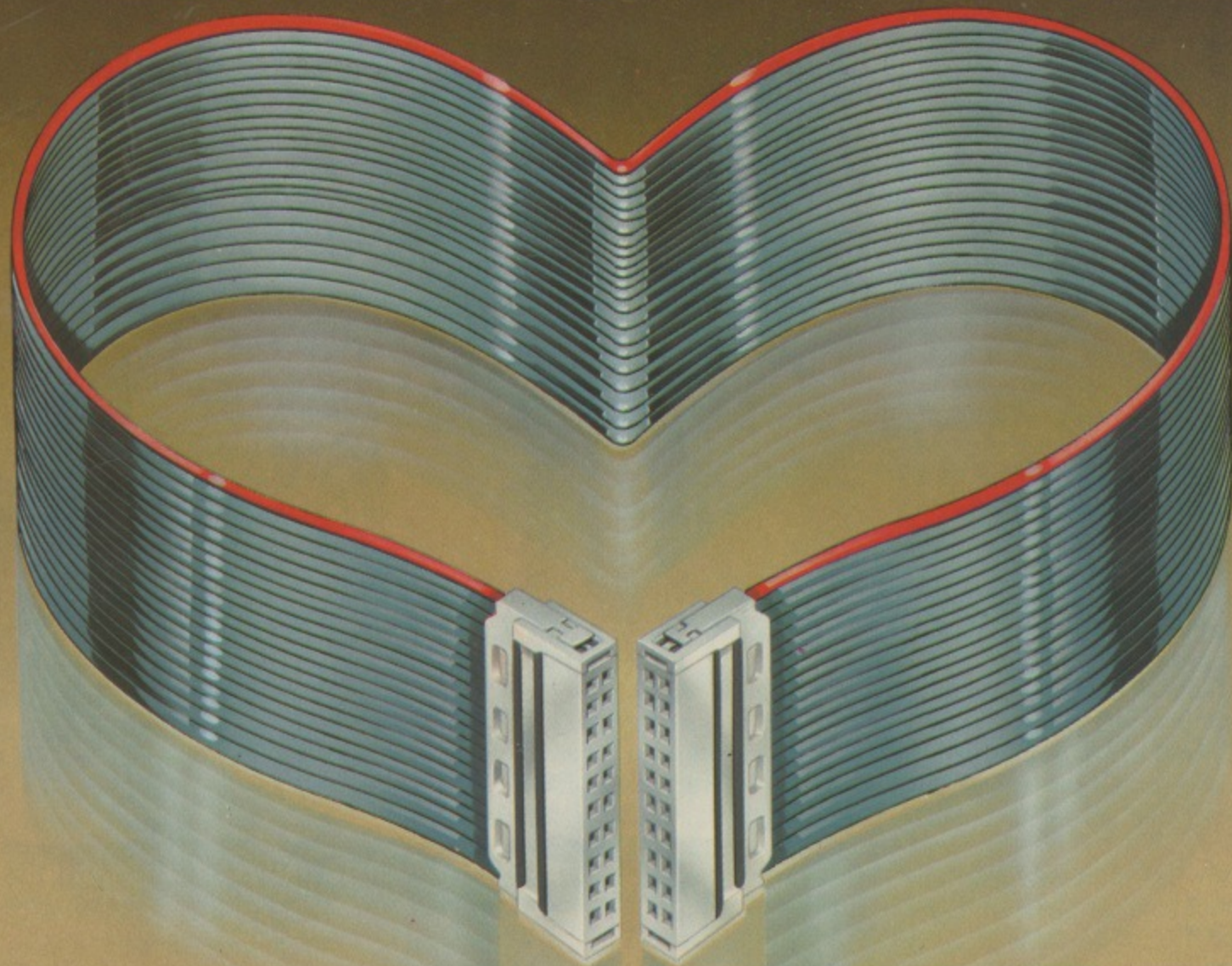

Most leading low cost Micros, eg BBC, Dragon and Sinclair QL love the MT-80 printer from Mannesmann Tally. It is fully hardware compatible and with a range of cable options, gives trouble-free straight through plug-in facilities.

You'll love it too, for its sophisticated looks, and its range of *standard features*, which include 80 col, 80 cps optimised bi-directional printing with dot addressable and line graphs, quick tear-off facility, friction and tractor feed, and easy change cassette ribbon. And all for an ex-VAT price of around £200.

Options include <55dBa sound reduction kit and 2K buffered serial interface.

The dealer who supplies you is supported by Mannesmann Tally, Europe's leading printer manufacturer. Your guarantee of continued support and assistance throughout the life of the printer.



Ask your nearest dealer for a demonstration, or phone us today for full details. Either Annie, Sali, Terry or Geoff will be only too pleased to help you.



MANNESMANN TALLY
THE FIRST NAME IN PRINTING

Mannesmann Tally, Molly Millar's Lane, Wokingham, Berkshire RG11 2QT
Telephone (0734) 791619/791533 Direct Lines or (0734) 788711 Switchboard

THE Adventures of Tintin by Herge are as French as an empty packet of Gitanes in the dust. But he travels well, and first appeared in English in the Eagle comic of the early 1950s.

Actually they only ran one story – King Ottokar's Sceptre – but I became a Tintin fan and, when I lived in Paris, I read all his adventures in the original, usually browsing in a drug store on the Champs Ellises near the Place de Toilet.

I recently visited France to do research for this article – that is, browse through the French micro magazines and books.

There are now about six magazines compared to two last year, but they are still pathetic. Most of the hardware is American and all the programs are Basic with French variables.

Thanks to the French wasting their money on food, drink and holidays we have, as usual, a comfortable lead over them where it really counts plus, because we speak English, we gather more easily the crumbs from the American table and 'Sayonara' to IBM is still a long way off.

However the French do intend to catch up and they will. Tintin was only just behind Dan Dare into space. But of the seven adventures I saw reviewed in French, only one of them was IN French.

Surely they can do better than that. And it's about time the Germans came out with The Ring of the Nibelungen by Wagner.

Now there's a real hero. Just imagine the Valkyries coming in to pick up the pieces when you've fouled up. And as for Siegfried's funeral music – the Hobbit was an (intended) joke in comparison, a bit of British whimsy.

In the meantime, it's obvious that an adventure in a foreign language could be more educational than most of the rubbish on the market. I don't just mean yet another variation of Space Invaders, but software that claims to teach you French by poisoning fish and so on.

Why the French, or anybody for that matter, aren't pirating adventures is just as baffling to me as why people spend the money, time and trouble to play them.

Few people approve of pirates, but they have been around since before Asterix so I have no sympathy for companies who blame their problems on the copying of software. A lot of this is

Have I ever played an adventure? Well, I've 'cheated' a bit..

Alice through the VDU

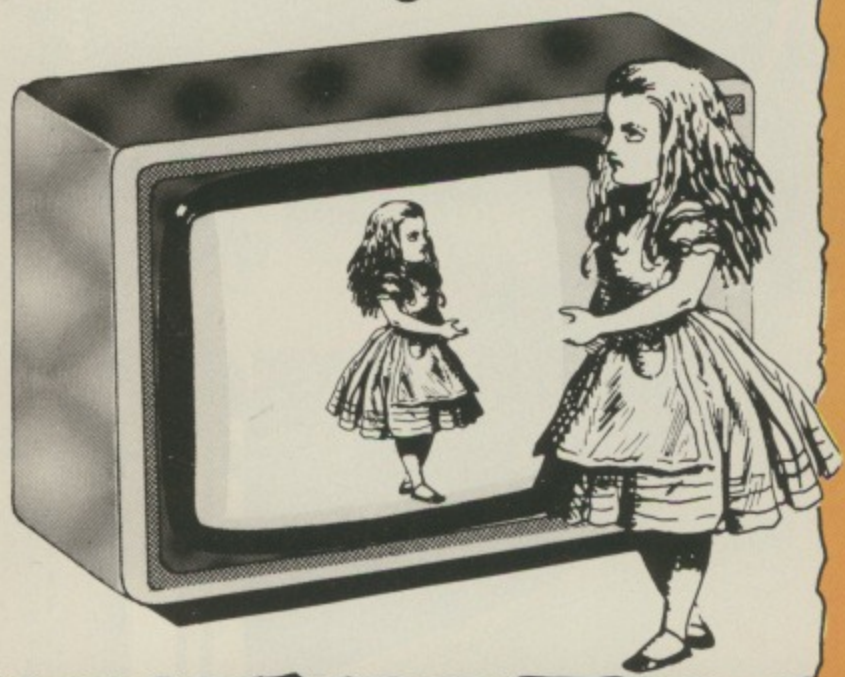

Our monthly foray into Adventure games

free advertising for the company to people who would never have bought the full price original.

I'm in a forthright mood because I received the following from Simon Clarke president of the International Adventure Club – I thought adventurers were loners and hated being organised, still . . .

Dear Whatever the hell your name is, just one question – have you ever played an adventure?

Let me explain a few economic facts of life to the president. I receive about five games a month to review. The senders want me to say something funny, clever and appreciative about their funny, clever and dirt-cheap game as quickly as possible.

I could ask any of them to send me a complete solution and most of them would, but that would be cheating so I "cheat". That is, I do what most readers could easily learn to do themselves.

Of course I have the advantage of a printer so if I can get a listing, I solve as much as possible on the train to work. This also saves me buying The Times just for the crossword and cheating with a dictionary or Thesaurus.

In similar vein, Peter Killworth, author of Philosophers Quest, Castle of Riddles and Countdown to Doom – so ask him not me – took umbrage at my telling you how to list the messages in his games because he thought this spoilt the entertainment.

The fact is I don't care what people do with what they buy so long as they do it quietly.

Actually I thought I was doing Peter a favour because people write to me saying they have bought one of his games (still among the best), got hopelessly stuck and swear they'll never buy another unless I (why me?) help them.

By the way, I'm not answering any

more letters that are not accompanied by SAEs.

Funny thing is that I also got a letter from a vicar telling me how to break a game – “Just the sort of stuff you’d need for a review!”

In fact I got a lot of thanks for that particular hint, and R.W. Crisp even sent me a tape, called Reveal, to break Sphinx Adventure. I appreciate the thought, but I had done that one (see the January issue).

Next month I will deal with some of the ways to protect a game but, briefly, the only two ways to protect Basic games are either that the answers are not in the program, or all the messages, etc, are encoded on a disc and are too much trouble to decode, meaning it’s simpler to play the game than break it.

Having been away, the games have piled up. My apologies to Epic who sent me three games months ago – they were Castle Frankenstein, Quest for the Holy Grail (it’s somewhere in Sheffield I think) and Kingdom of Klein.

I groaned when I got them – I can write a whole article on just *one* game and I obviously had to solve all three together, but they were in machine code and all have more than 220 rooms.

Peeking revealed lots of mazes, roughly 80 verbs, 60 objects and some “dropped pearls” which are always difficult to sort out even with a listing.

They also have the cheek to respond to HELP with: “Try thinking a bit harder, everything is logical”. Then they expect me to think that a flying broomstick is logical. Mr Spock might agree it is predictable, but it is not logical.

Did you know that carpets can fly? Kingdom of Klein doesn’t even know what a carpet is, so why should I assume it knows what a portrait is?

If you play fair, you have to keep trying to get any object mentioned until you get an encouraging response like: “You can’t do that yet”, rather than: “I don’t know what a KNOTTED is”.

Anyway I’d barely picked up the umbrella in Kingdom – which doesn’t belong to me – when, I assume, the owner searched my office and took all the tapes plus The Hobbit and Pimania (Melbourne please note – I have really missed The Hobbit).

However Merlin was doing a grand job on the Epics so I thought I was off the hook, but then The Wheel of

Fortune rolled in followed by a complete set of messages, verbs and nouns.

I still haven’t managed to eat the matches and the room descriptions are somewhat repetitive but it is a massive complex game and well worth the money.

Epic deserves success, fast cars and bankruptcy after a couple of years.

I once met a businessman who told me the secret of success – remember tealeaves? Pour a pot of them down the toilet and pull the chain. *Après le déluge*

empty and the ground was wet at the vending machine.

I did kill a dwarf but that’s because I always throw the axe down just in case one is about to appear – it seemed to be genocide.

A plus is that the program includes all the shortcuts like SECRET, BED-QUILT, FORK, BARREN and RESERVOIR (Level 9 missed them out) so I zoomed round and was soon carried off by the elves but only 140 points out of 210, and nowt for Witts

I don't know
what a knotted
is.

there is always just one leaf left floating in the pan – that’s success.

For a fee I’ll even tell Epic the secret of peace and tranquility, which is also the reason I’ll never be president of anything.

I’ve now had new improved copies of the stolen Epic games. They load to Fingal’s Cave by Mendelssohn, not *Gudonov* because Castle Frankenstein really needs *Night on a Bare Mountain* by Mussorgsky, but at £8 each they are all good value.

No hints, *right* to EPIC if you get stuck or critical as they deal exclusively with games for the BBC and take care that the messages are spelt *write*. A professional product and company.

The next game is *Classic* by Melbourne. Now I know *Colossal Cave* like the back of my hand, so no perspiration but the pirate must be on holiday (a summer cruise?) and the dwarves are notably rather subdued with only one axe between the lot of them.

Also the snake is no longer a pushover but there are a few bugs with the bird in the cage – try: DROP CAGE.GET CAGE. LOOK and you’ll see what I mean.

I dropped the bottle at the giant’s door – as usual – and then found it was

End, so even if you’ve played the original this is still worth the £7 – a price that is as amazing as how to kill dragons.

If you haven’t solved *Colossal* or *The Hobbit* or *Scott Adams’ Pirate and Adventureland* and want to ruin the entertainment – it’s your money – then get Mike and Peter Gerrard’s book, “*The Adventurers Companion*”.

Their justification is that if the authors don’t publish a solution then somebody has to cut the divorce rate.

Of course, that someone is going to make errors – even the authors overlook some solutions and Edsgar is still trying to write the perfect program – so the red herrings of the rod and the vending machine are both described with no comment on the time wasted.

The book is written in an amusing way but I wouldn’t have included a single *Scott Adams* game let alone two. And the solution to *The Hobbit* has already appeared. So five out of six for presentation but only two for content.

You may have noticed that in my review of *The Hobbit* I made some guesses. For example I knew that *Thorin* could carry *Bilbo*.

Reading the solutions I find the

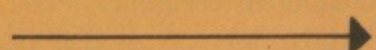

From Page 81

ending rather disappointing – surely Bilbo and Thorin should get to Smaug, then Thorin acts as decoy while Bilbo steals the treasure and gets chased back to Laketown. Not quite like the book, but Bilbo has to be on the scene when Bard goes into action.

It's inconsistent that Bilbo can carry Bard, who must be a lot bigger than Thorin, and nonsense to allow him to climb with such a burden.

One for the family

THE Mystery of the Java Star by Shards Software is an unusual game in four parts (only four?). You have to recover the gold and the Java Star – a ruby – from a shipwreck somewhere in the South Atlantic.

In the first part you choose one of three levels of difficulty which gives you either £12,000, £8,000 or £4,000 to play with. You must then piece together some "scraps of paper" (a 6*7 matrix) to make a map and a message. This part is quite clever because they vary each time you play.

In the second part you have to visit places in London to get further information and funding. There is a choice of 31 places and it takes a while

Have flair with Lair

THE Lair by Utopia doesn't work so have a look.

It says CHAIN "LAIR" and then finds 30 sections called FLAIR. So fix that – good job I don't actually play these games – and decide that I want to be a Priestess rather than a Warrior, Elf or Pillock and set Strength 100, Skill out of sight, Magic 32000, Gold 1000000, Rations 0 (must watch my figure) and Experience infinite.

You can go N, S, E, W, eat rations, store position and respond to prompts like: 'You can see an awkward Orc. Do you wish to bribe him?' Orcs usually take your money – even when you bribe them with nothing – and combat ensues.

Of course I beat the tar out of everything in the caves – there are about 20 different creatures – and as for the Mighty Sorcerer, I just brushed him aside, though he is a tricky bird.

to pick out the relevant ones.

Fleet Street is particularly good – I sold my story so many times I hardly needed to find the treasure.

To finish this section you have to answer the same five questions – a pity because this could have been randomised.

In the third part you have to locate the correct island. In the fourth you must dive, in real time, to recover the treasures, and then you have to solve the mystery of the ruby. Rather like Eskimo sculpture, it's meant to be felt rather than seen.

Some nice pictures, music ("We are sailing", "If I were a rich man") and probably best played as a group or family. But not "educational".

Political applications

HOW many cats know that a Purdy is a double barrelled shotgun? But why capital "P" – does Dennis also play around with a Mashie Niblick at the 19th?

Dennis Through the Drinking Glass by Applications Software is as close to libel as Casanova's parrot was to slander.

It's not fair because the Editor won't let me make political jokes and chopped a puzzle that barely mentioned the blessed Margaret. Actually I've never

The 200 rooms are exceedingly dull with just the occasional pit to avoid and the usual Funeral March if you don't.

Obviously based on the "Warlock of Firetop Mountain" it barely captures the spirit – no puzzles, no room descriptions and no particular objective.

Far better is Swords-Sorcery by Kansas but only if you like D&D battling.

I know Don Quixote thought that randomness was the essence of adventure but I quickly get bored with bribing, bashing and bumping around mazes with a set of feeble, bumbling wierdos.

Still everyone a *son gout* and the map is a nice idea.

Talking about gout, did you know that the French refer to the GB cars as *Gorge de bois*? that is wooden throat, meaning boozier, meaning keep clear!

voted ***** probably because I'm only seven years old.

Now I'm all for women in power, particularly Ministeras Primas, but two things I can't abide are intolerance and inebriation.

I think you should get a licence to drink OR drive every year. If people want to disconnect their brain cells in private that's their choice but I've had my car bashed too many times to think drinking is funny.

Enough *matronising*, in this game you can get stuck into the Tory's greatest assets – Tony Benn, along with Norman Rabbit – don't turn into a lettuce leaf when he's around – and good old Ken Livingstone. Such a nice smile.

Your objective is to avoid Maggie and get to the pub for a clinker before closing time. The messages are in doggeral and quite amusing. If you get caught then, as an old American friend used to say, "You're *** is grass and I'm the lawnmower".

Not a real adventure, but amusing and quite educational.

Actually, the funniest thing I've seen recently was somebody asking how to open the Snowball security door. Morris Minor replied: "Hit Nightingale with spanner. Take syringe. Prise door open with syringe". and here's me thinking I could use a screwdriver when really it's the other crew member who needs a drink.

☆☆☆

SEA Adventure by Virgin is quite the opposite of educational. There are only 10 commands, all done with the *f* keys. So "no more typing degrees required to play this game!"

The author is an amateur who probably thinks Chomsky 2 is a dog food and that Hash Tables are found in Wimpey bars.

A five year old could solve this and then probably find learning to type more interesting.

☆☆☆

ONLY one solution to Quasimodo's problem in the August issue of *The Micro User*.

Line 40 should have been:

```
40 N= 2 + RND(8)
```

which the solution has pointed out. Answer next month.

No answers to the Filthy Fifteen in last month's issue. Note that line 200 needs:

```
: P(Y,Z) = 1
```

concatenated.

Alice

THE ALLIGATA WILL ALWAYS GET YOU

Another set of amazing specials from the software house with the reputation for fast machine code action, high resolution graphics and unbeatable quality. Games to keep you enthralled. Games to get hooked on, but never bored, because once you've started you'll keep coming back for more.

At only **£7.95**
(Disk £11.95) you should bite our arm off

HELP!

He'll bite chunks out of your BBC Model B.



Son of Blogger
An enthralling sequel to the famous Blogger as you follow the antics of Slippery Sid through one continuously scrolling adventure, challenging death in his search for the golden keys.



Xanadu Cottage/Ebony Tower
A treasure trail adventure to places you'd never dream of. An unexplored journey to lands in wait of the final bloody encounter. Two adventures giving hours of absorbing enjoyment for the bargain price of one.



Tarzan
A multi-screen spectacular featuring the Lord of the Jungle in his relentless fight through 4 vicious levels of ferocious blood thirsty beasts and river obstacles in order to save his darling Jane from her awesome fate. Sloppy stuff but well worth fighting for the climax.



5 BEST SELLERS
£9.95 £13.95
CHARTBUSTER
Chartbuster
Five outstanding games in one package - Blogger, Neanderthal Man, Web Runner, Monaco and Eagle Empire. Hits you may have seen or heard about but could never afford, now available in this 1984' bonanza.



CLAUDE
Claude
Arcade excitement - 11 compelling levels of fast moving action; a nasty evil capitalist in Uncle Claude and poor innocent Micky vainly trying to save his friends jobs - all creates a game that's a must for any games enthusiast.

- Tarzan Chartbuster Uncle Claude
 Son of Blogger Xanadu Cottage/Ebony Tower

Please indicate programs required and whether tape T or disk D

I enclose a cheque/PO* for £ _____

Charge my Access _____

Card No. _____

Name _____

Signature _____

Address _____

Alligata Software Ltd
1 Orange Street, Sheffield S1 4DW
Tel: (0742) 755796



*Payable to Alligata Software †Allow 75p for post and packaging
Despatch is normally made on receipt of order and should reach you within 7 days

DUEL!

By EVAN VENN



DUEL isn't the most original game we've ever published. How could it be, since it's based on one of the most popular arcade games ever?

We can guarantee, however, that it's one of the most compulsive, intriguing, addictive and infuriating games ever to appear in *The Micro User*.

It's for two players, and don't play it with people you want to stay friends with – or married to. Heaven knows what would happen if poor old Bob could entice Andrea into a game...

The scenario couldn't be simpler – both you and your opponent must move round a rectangular board. But as you do so, you leave a deadly ion trail.

You must avoid both your own and your opponent's trail in order to survive. Hitting the surrounding wall is just as fatal.

Subtlety is not Duel's strong point. The survivor wins the round, and the first to victory in 10 such combats wins the game.

On running Duel you will be asked if you intend to use the keyboard or games paddles. Press P for paddles and K for keyboard. Similarly, S for sound and Q for quiet.

Player No.1 appears on the left with a red ion trail. His keys are:

Q Up
X Left C Right
A down

Player No.2 appears on the right with a green ion trail. His keys are:

[Up
< Left > Right
* Down

At the end of each combat the scores are displayed and the loser's ion trail flashes.

If things get too dire, pressing Break will take you back to the start of a new game. But don't expect your opponent to be too happy about that...

PROCEDURES AND FUNCTIONS

PROCgo

PROClift

PROCright

FNpaddles(P%,OD%)

FNboardR(OD%)

FNboardL(OD%)

PROCreadch(H%,V%)

PROCgraphics

PROCliftercrash

PROCrightcrash

PROCgrid

PROCscore

PROCwinner

PROCsound

PROCinstruct

PROCbar

Main loop. Program alternates between right and left player until a crash occurs.

Left player. Main routine – checks paddles, keyboard, reads character, prints characters, makes sound and finally checks for crash.

Right player. Main routine – checks paddles, keyboard, reads character, prints characters, makes sound, finally checks for crash.

Reads paddle status. P% indicates paddles number and OD% indicates old paddle direction.

Reads keyboard status for right player and OD% indicates old keyboard direction.

Reads keyboard status for left player and OD% indicates old keyboard direction.

Reads screen for character.

Sets VDU 23s and scores to zero.

Left player crash. Increments other player's score, makes screen flash and checks for winner.

Right player crash. Increments other player's score, makes screen flash and checks for winner.

Using character graphics draws grid, sets positions and direction of players.

Prints scores.

Prints which player has won.

Sound.

Prints instructions.

Waits for space bar to be hit.

game
it be,
most

at it's
going,
over to

play it
friends
knows
Bob

...
ler -
move
s you
il.

n and
rvive.
st as

point.
d the
wins

ked if
ames
K for
nd Q

with a

with

ores
trail

reak
new
nent

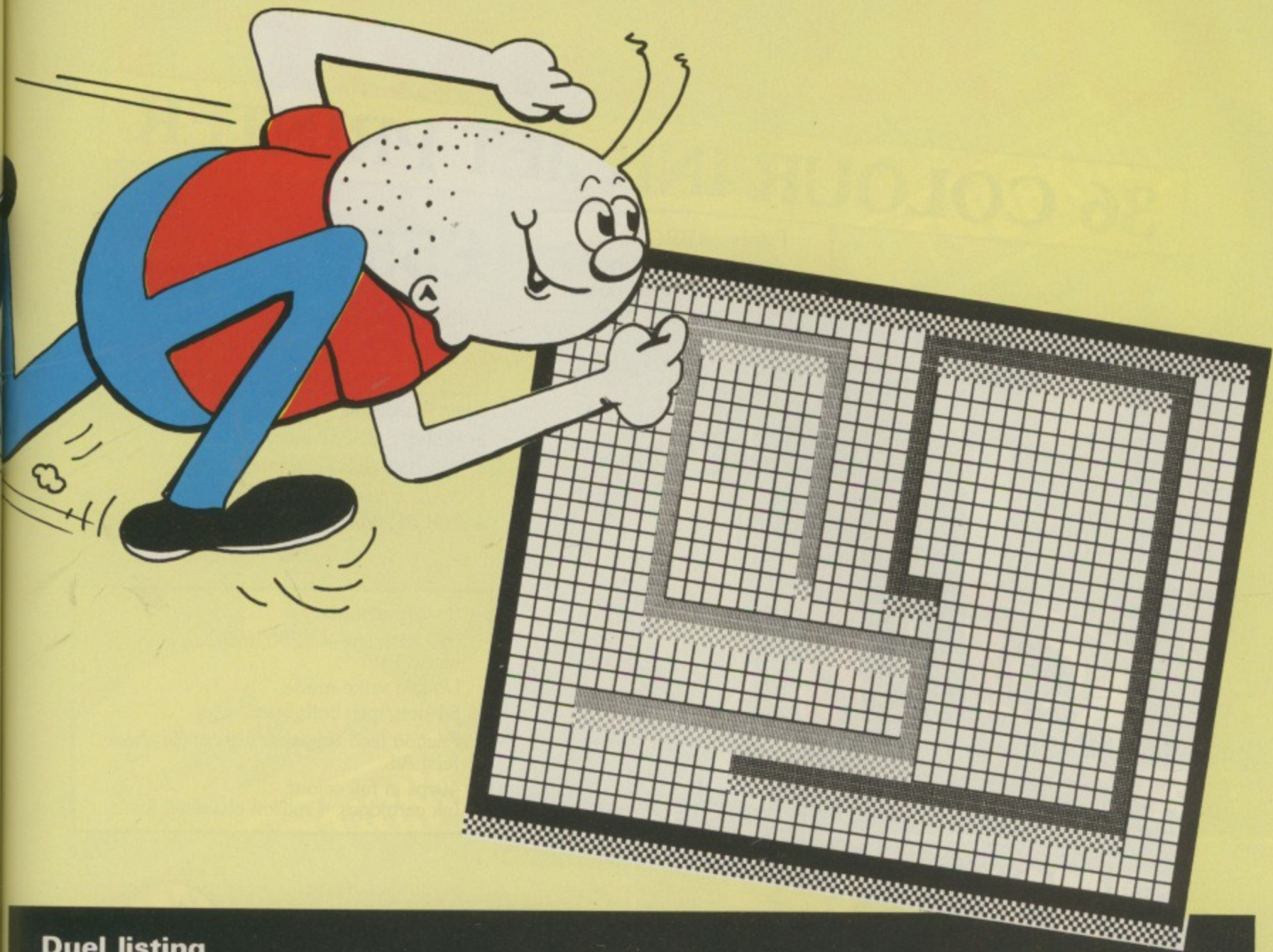

Duel listing

```
10 REM *****
20 REM (C) Micro User
30 REM *****
40 *KEY 10 OLD:MRUN:IM
50 PROCgraphics
60 MODE1:PROCinstruct
70 DNERRORGOTO90
80 REPEAT
90 leftcrash=FALSE:rightcrash=FALSE
100 PROCgrid
110 IFsound=1 PROCsound
120 IF(RND<.5) PROCright
130 REPEAT
140 PROCgo
150 UNTIL leftcrash OR rightcrash
160 IF leftcrash PROCleftcrash
170 IF rightcrash PROCrightcrash
180 UNTILFALSE
190 END
200 REM*****
210 DEFPROCgo
220 PROCleft:IF leftcrash ENDPROC
230 PROCright:IF rightcrash ENDPROC
240 ENDPROC
250 REM*****
260 DEFPROCleft
270 IFboard LX=FNboardL(LX) ELSE LX
    =FNpaddles(1,LX)
280 XX=XX+(LX=4)-(LX=2):YX=YX+(LX=1
    )-(LX=3)
290 PROCreadch(XX,YX)
300 VDU19,1,1,0,0,0,17,1,31,XX,YX,2
    26
310 IFSX=8THENVDU31,XX,YX+1,224
320 SOUND0,-15,10,sound
330 IFTX=15 leftcrash=TRUE
340 ENDPROC
350 REM*****
360 DEFPROCright
370 IFboard RX=FNboardR(RX) ELSE RX
    =FNpaddles(3,RX)
380 AX=AX+(RX=4)-(RX=2):BX=BX+(RX=1
    )-(RX=3)
390 PROCreadch(AX,BX)
400 VDU19,2,2,0,0,0,17,2,31,AX,BX,2
    26
410 IFSX=8THENVDU31,AX,BX+1,224
420 SOUND0,-15,20,sound
430 IFTX=15 rightcrash=TRUE
440 ENDPROC
450 REM*****
460 DEFFNpaddles(PX,ODX)
470 LOCALCX
480 DX=0
490 ch1X=128-(ADVAL(PX) DIV 256):ch
    2X=128-(ADVAL(PX+1) DIV 256):IF ch1X=
    0 THEN ch1X=1
500 IF ch2X=0 THEN ch2X=1
510 CX=ABS(ch1X/ch2X)
520 IF ch2X>80 AND CX<1 DX=3
530 IF ch2X<-80 AND CX<1 DX=1
540 CX=ABS(ch2X/ch1X):IF ch1X>80 AN
    D CX<1 THEN DX=2
550 IF ch1X<-80 AND CX<1 THEN DX=4
560 IFDX=0 =ODX
570 =DX
580 REM*****
590 DEFFNboardR(ODX)
600 LOCALCX
610 DX=0
620 DX=((INKEY(-57))*-1)
630 IFDX=0 DX=((INKEY(-104))*-2)
640 IFDX=0 DX=((INKEY(-103))*-4)
650 IFDX=0 DX=((INKEY(-73))*-3)
660 IFDX=0 =ODX
670 =DX
```

Turn to Page 187

COLOURJET

36 COLOUR INK JET PRINTER

Prints all BBC Micro
screen Modes inc.
Mode 7 . . . in full colour

£550 (Rec. price excl. VAT)

With Centronics parallel interface
and free BBC Micro dump listing.

Prints overhead transparencies

Options available:

- Buffered RS232 interface.
- Viewdata & RS232 interface.
- Apple II interface.
- IBM PC dump.

Specifications:

640 dots/line + 1280 dots/line high res mode.

Double strike mode.

84 dots/inch both axes.

Friction feed rollpaper with single sheet feed A4.

40cps in full colour.

Ink cartridges, 4 million character life.

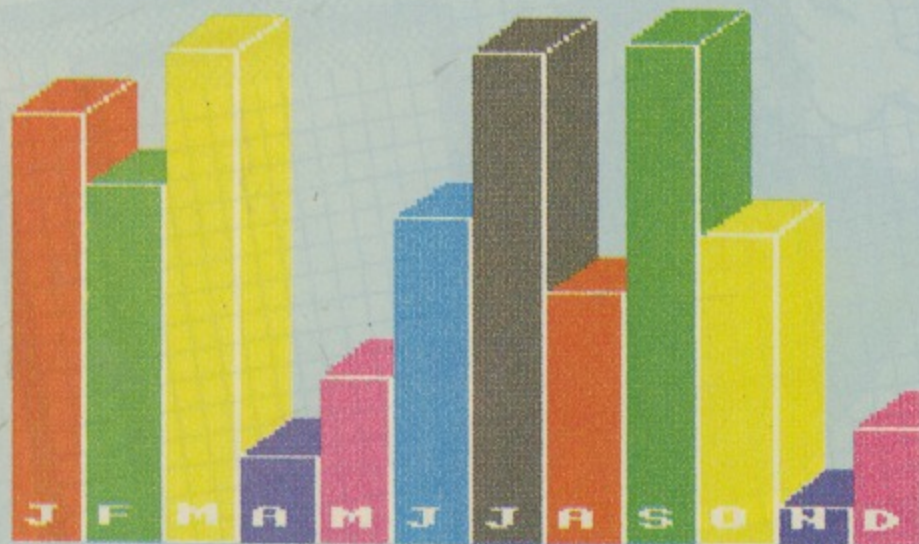

from BBC Micro screen - 1/2 size mode

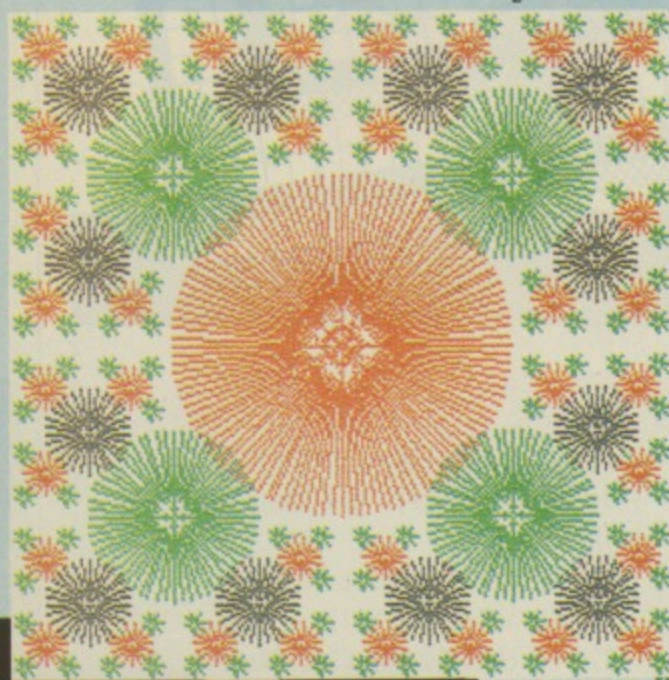

Virtually
silent

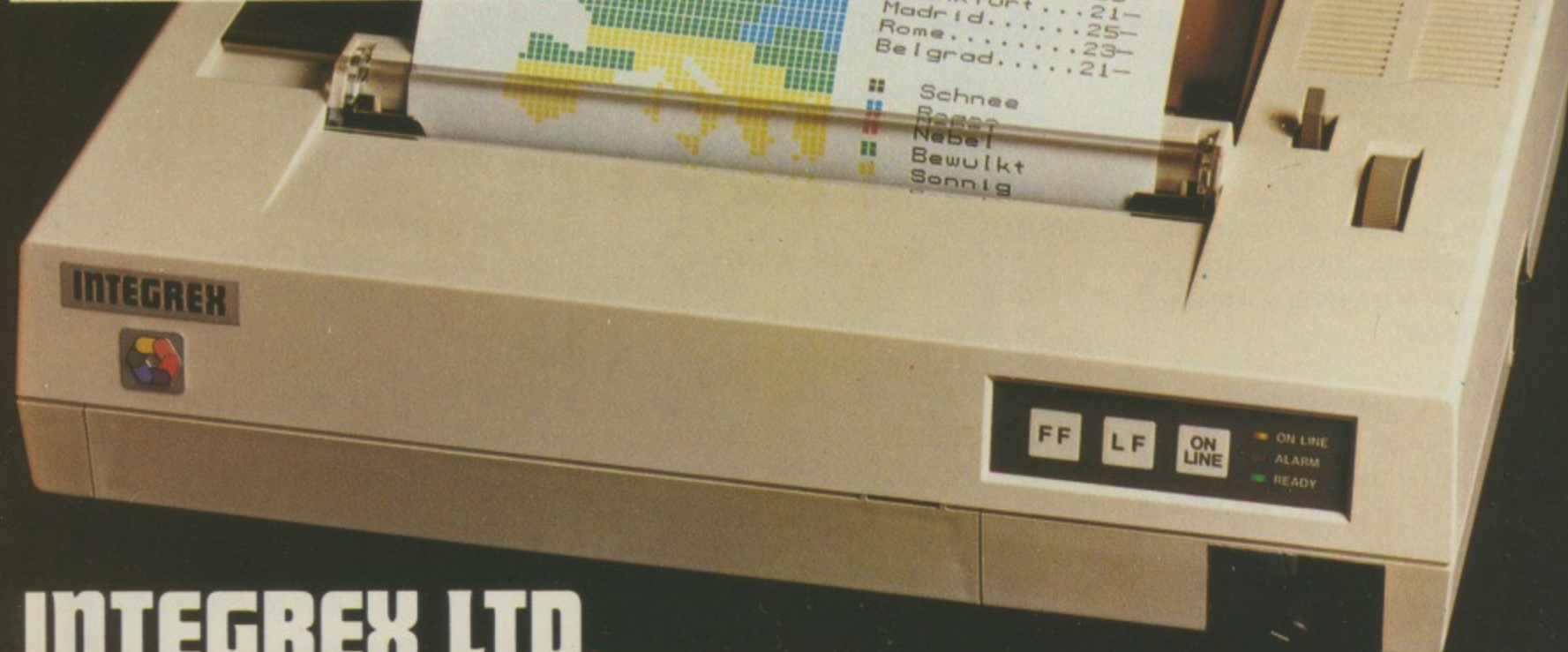

INTEGREX LTD.

Church Gresley, Burton-on-Trent, Staffs DE11 9PT
Tel: 0283 215432 Telex: 377106

Dealers, OEM & Educational
enquiries welcome

SEE THEM
LIVE!
SEE THEM IN
ACTION!

Explore Pace's
state-of-the-art
E-net Classroom

NETWORKING

All your questions
answered by
the experts

Link into
Micronet and
other giant databases

COMMUNICATIONS

Dial Knowledge Index
in the USA - direct
from the Show

ELECTRON &

BBC MICRO

USER SHOW

Communications and networking are the twin themes that are creating the greatest interest among users of microcomputers. In special presentations at the October Electron & BBC Micro User Show we unveil the mysteries and show how your computer at home can send and receive messages from all parts of the world.

Alexandra Palace, London N22

Thursday to Sunday,
October 25 to 28

This voucher is worth £1 per head

Reduced prices for School/College Groups

Entry only £1 per student if bookings are made in advance. Send your cheque (made payable to Database Publications) and SAE to:

Electron & BBC Micro User Show
68 Chester Road, Hazel Grove,
Stockport SK7 5NY
Tel: 061-456 8383
Valid for a minimum of 10 people

SAVE MONEY with our Special Travel and Hotel Offer

Visitors to the Show can obtain cut-price rail tickets from ANY station in the United Kingdom - plus special reduced prices at London hotels. Write to:

Travel Offer, P.O. Box 1, St. Albans AL1 4ED with SAE or Telephone: St Albans 34475 quoting: The Electron & BBC Micro User Show.

ELECTRON &
BBC MICRO
USER SHOW

By handing in this voucher at the door you save £1 off the normal admission price of £3 (adults) and £2 (children).

(Valid for a maximum of 4 people)
(Only 1 voucher per person)

10am-5pm, Thursday, 25 October
10am-5pm, Friday, 26 October
10am-5pm, Saturday, 27 October
10am-4pm, Sunday, 28 October

Alexandra Palace
Wood Green, London N22.

Number attending: 1 2 3 4

FROM VIGLEN®

Complete ROM Cartridge System for the BBC Model B.

... store your growing collection of ROM's in purpose-made protective cartridges! Insert and remove from your micro in absolute safety without damaging the pins of your ROM's!

... your BBC Micro comes complete with a special vent on the hand side of the keyboard (see 6), and unused ROM sockets (see 10).

The Viglen ROM Unit consists of a "ROM plug" (see 9), which plugs in to the "ROM socket" (see 10), which passes under the BBC outer case (see 5) through the vent (see 6), and connects perfectly on to the vent.

Connect the ROM Chip (see 2), place ROM Cartridge Cup, IM and the unit is fully operational. Once this simple process is done you simply plug in the ROM Cartridge (see 3).

You may have as many "ROM Cartridges" as you wish - say, word processor, accounting, spread sheets etc., simply plug in to the ROM Cartridge Socket!

The "VIGLEN ROM CARTRIDGE SYSTEM" comes complete with ROM (1 & 3), ROM CARTRIDGE SOCKET (4), ROM CABLE (8), ROM PLUG (9) and cover.

Complete Kit, including one cartridge £19.95 inc VAT.
 5 Extra ROM Cartridges £27.75 inc VAT.
 10 Extra ROM Cartridges £49.50 inc VAT.
 Single Cartridge £6.95 inc VAT.



ROM CARTRIDGE SYSTEM

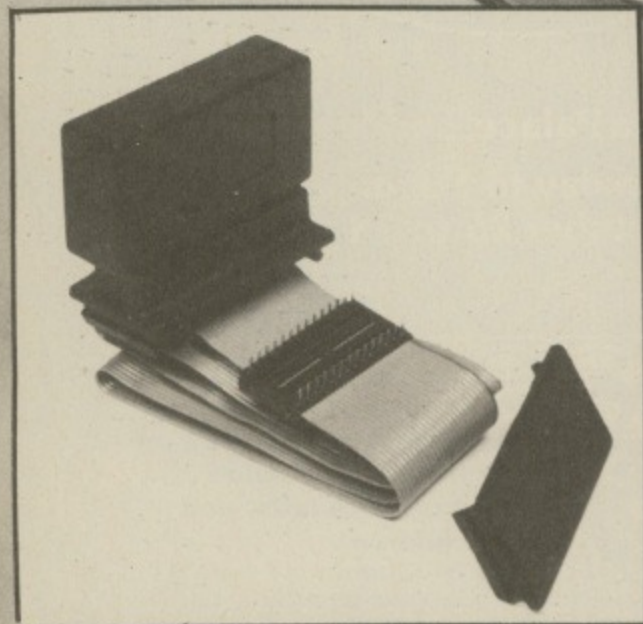

Viglen
 COMPUTER SUPPLIES

Unit 7 Trumpers Way
 Hanwell W7 2QA
 Tel: (01) 843 9903



FREE PARKING

HOW TO ORDER.

By Post

To purchase your special ROM Unit, fill in the coupon below, enclosing your cheque/ P.O. made payable to VIGLEN COMPUTER SUPPLIES and post to us.

By Telephone

If you are an Access/Barclaycard holder you may order by telephone, simply give your Card No., name and address and item(s) required.

In Person

You are welcome to visit us; the nearest underground station is BOSTON MANOR.

Please allow 7-28 days for delivery.

Post to: Viglen Computer Supplies, Unit 7, Trumpers Way, Hanwell, London W7 2QA
 Please send me (state No. required)
 I prefer to pay with my ACCESS/BARCLAYCARD (Delete whichever not applicable)
 Card No. _____
 Signature _____
 Name _____
 Address _____
 Credit cards valid if signed by
 Address above must be
 as per order form

Put an end to inefficient, slow cassette tape storage



Speed your data access with a TEAC disk drive from Viglen

Comprehensive, fact-filled, 53 page manual including techniques of loading from cassette to disc. Not available elsewhere

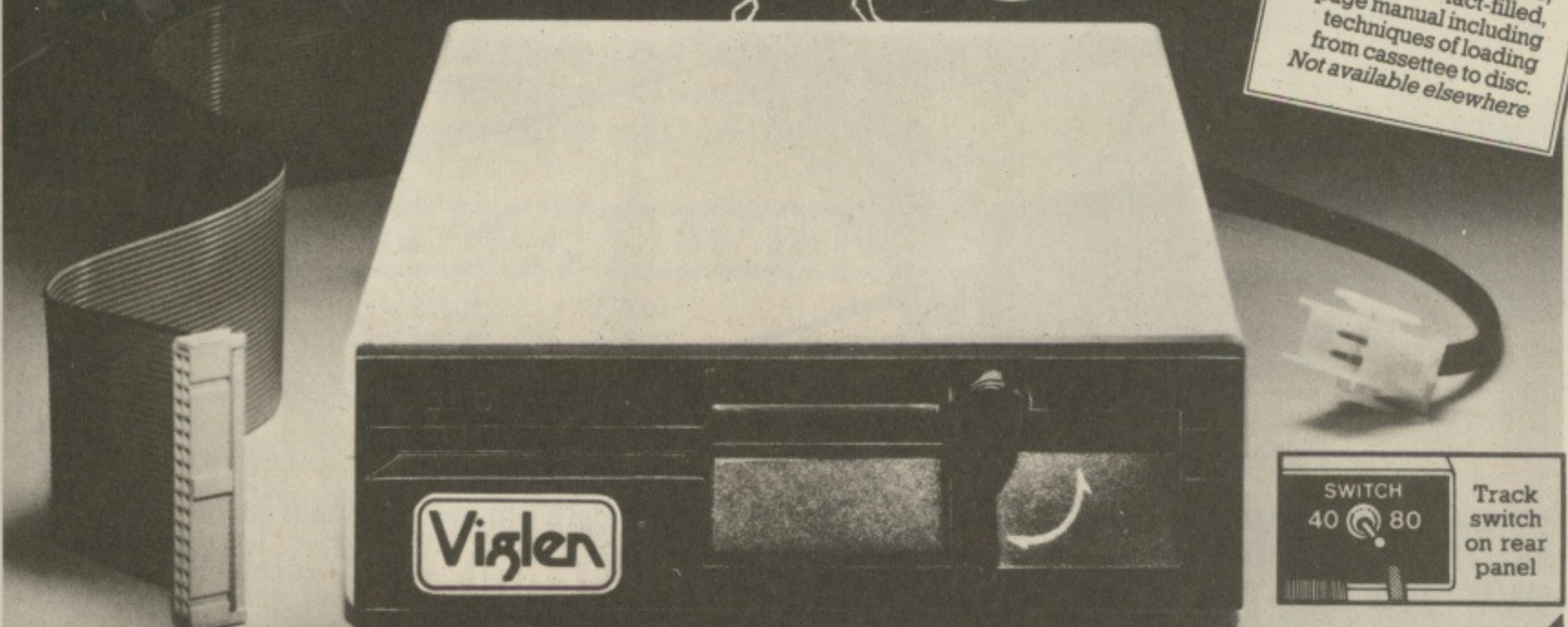

Replacing your cassette with a disk drive means data access in seconds! VIGLEN TEACS *unlike others* have been specially modified to operate successfully with ACORN and other filing systems, over coming RANDOM accessing problems normally experienced with these disk drives. Prices include VAT, Formatting Disk, User Manual, Case and Leads.

When ordering Dual Drives, please state which layout you prefer. A or B.

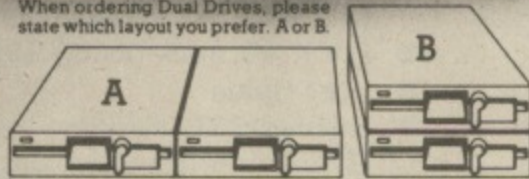

SWITCH 40 80 Track switch on rear panel

TEAC 55 Slimline Drives					
SINGLE DRIVES CASED	Incl. VAT	Excl. VAT	DUAL DRIVES CASED	Incl. VAT	Excl. VAT
40 TRACK 100K	£119.00	£103.48	40 TRACK 200K	£240.00	£208.69
40 TRACK 200K	£160.00	£139.13	40/80 TRACK 400K	£280.00	£243.48
40/80 TRACK 200K	£140.00	£121.74	40/80 TRACK 800K	£378.00	£328.70
40/80 TRACK 400K	£189.00	£164.35	Integral dual power supply	£45.00	£39.13
Integral single power supply	£25.00	£21.74	Acorn Disc Interface		Please Ring

All prices correct at time of going to press and all offers subject to availability.
 ● Utilities disk includes 13 useful utilities including: ● formatting ● verifying ● screen dump ● disassembler ● generating 62 files, etc. Please telephone 01-843 9903 for latest prices
 ● Orders welcomed from Educational Establishments and Government Departments.

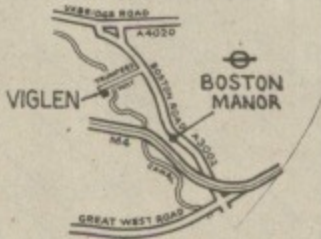

How to order

By post: To purchase any of the items simply fill in the coupon with your requirements. Enclose your Cheque/P.O. or use your Access/Barclaycard. Please make cheques payable to: VIGLEN COMPUTER SUPPLIES and post to above address. Allow seven days for delivery and add £8.00 carriage, package and insurance on all items.

By telephone: Ring (01) 843 9903. Credit Card holders (Access/Barclaycard only) can purchase by telephone. Please give Card No., Name, Address and the items required.

Full Twelve Months Guarantee

Viglen

COMPUTER SUPPLIES

Unit 7 Trumplers Way
 Hanwell W7 2QA
 Tel: (01) 843 9903

EASY ON-THE-SPOT PARKING. AND IT'S FREE!

Post to: VIGLEN COMPUTER SUPPLIES UNIT 7, TRUMPERS WAY, HANWELL, W7 2QA

Please send me the following items:

I enclose Cheque/P.O. for £ _____

I prefer to pay by ACCESS/BARCLAYCARD* Card No: _____

Signature _____

Name _____

Address _____

MU 11/2

CANON 200K DISK DRIVE & ACORN DFS

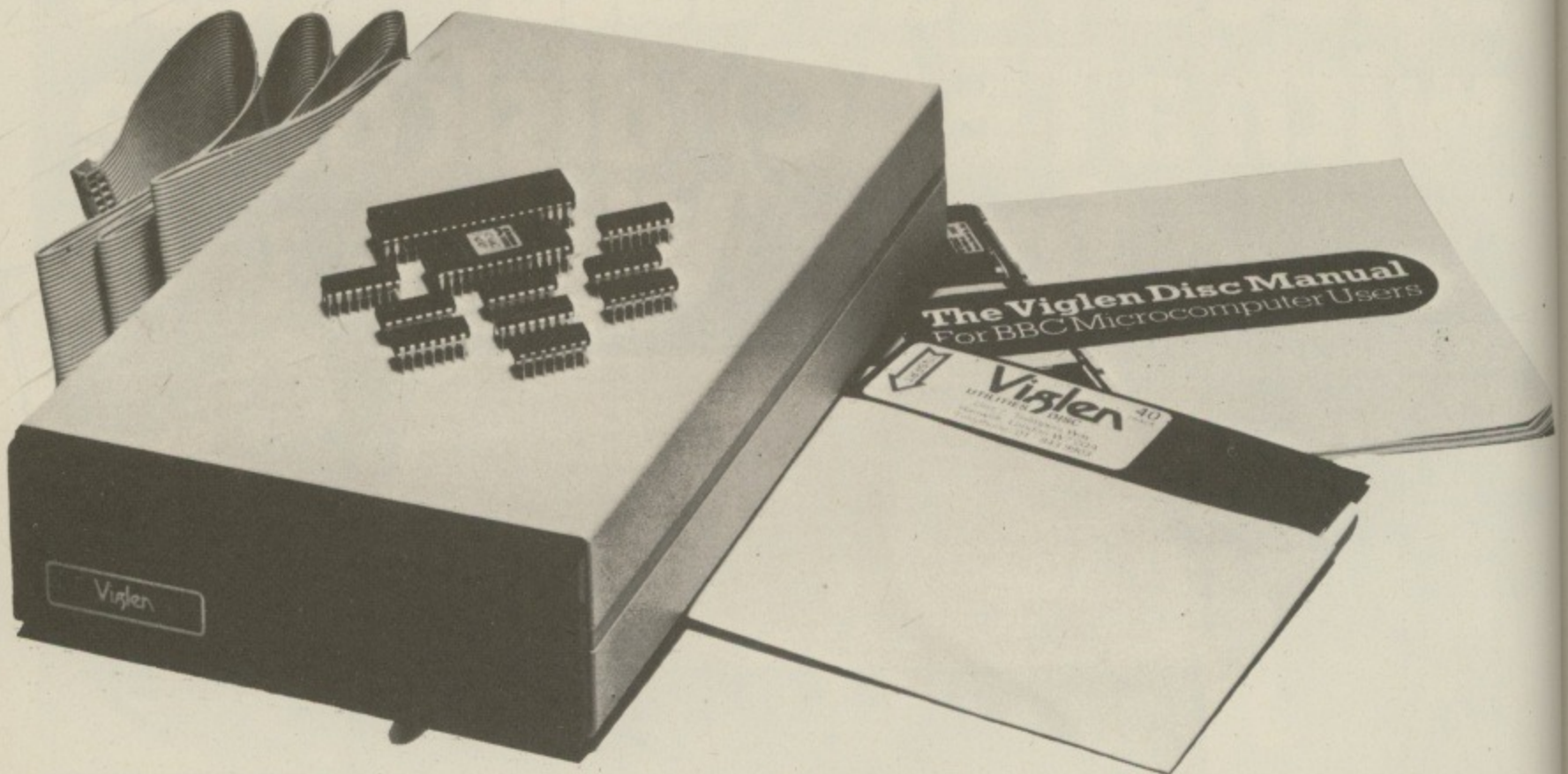

COMPLETE DISK SYSTEM FOR THE BBC MODEL B

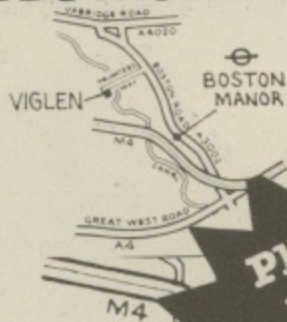

- Package assumes you own a BBC Model B with switched mode power supply plus 1.2 operating system.

OFFER INCLUDES:

- Disk Interface (call at factory for free fitting while you wait) or supplied with easy to fit instructions.
- 200K 40 track double sided Canon Disk Drive including case and all leads.
- User Guide.
- Utilities Disk including formatting, verifying, BASIC program comparator, disassembler, Epson screen dump, dual catalogue (giving 62 files), large printing and others.

Please Ring
01-843 9903
for LATEST
PRICES

DISK DRIVE
& ACORN
INTERFACE

Viglen

£199

INC
VAT

COMPUTER SUPPLIES
Unit 7 Trumbers Way
Hanwell W7 2QA
Telephone: (01) 843 9903
AMPLE ON-THE-SPOT
CAR PARKING -
AND IT'S FREE!

Prices correct at time of going to press - offer subject to availability
Post to: VIGLEN COMPUTER SUPPLIES UNIT 7, TRUMPERS WAY, HANWELL, W7 2QA

Please send me _____
(Qty) TEC 200K + DFS

I enclose Cheque/P.O. for £ _____
I prefer to pay ACCESS/BARCLAYCARD
(Delete whichever not applicable) Card No. _____

Signature _____

Name _____

Address _____

made out to VIGLEN COMPUTER SUPPLIES
(please add £8 for carriage)

MU 11/3

Buy from the specialists.

VIGLEN offer of TEC drives (As used by Cumana) beats all comers

Replacing cassettes with disc drives means programme loaded and data accessed in seconds not minutes.

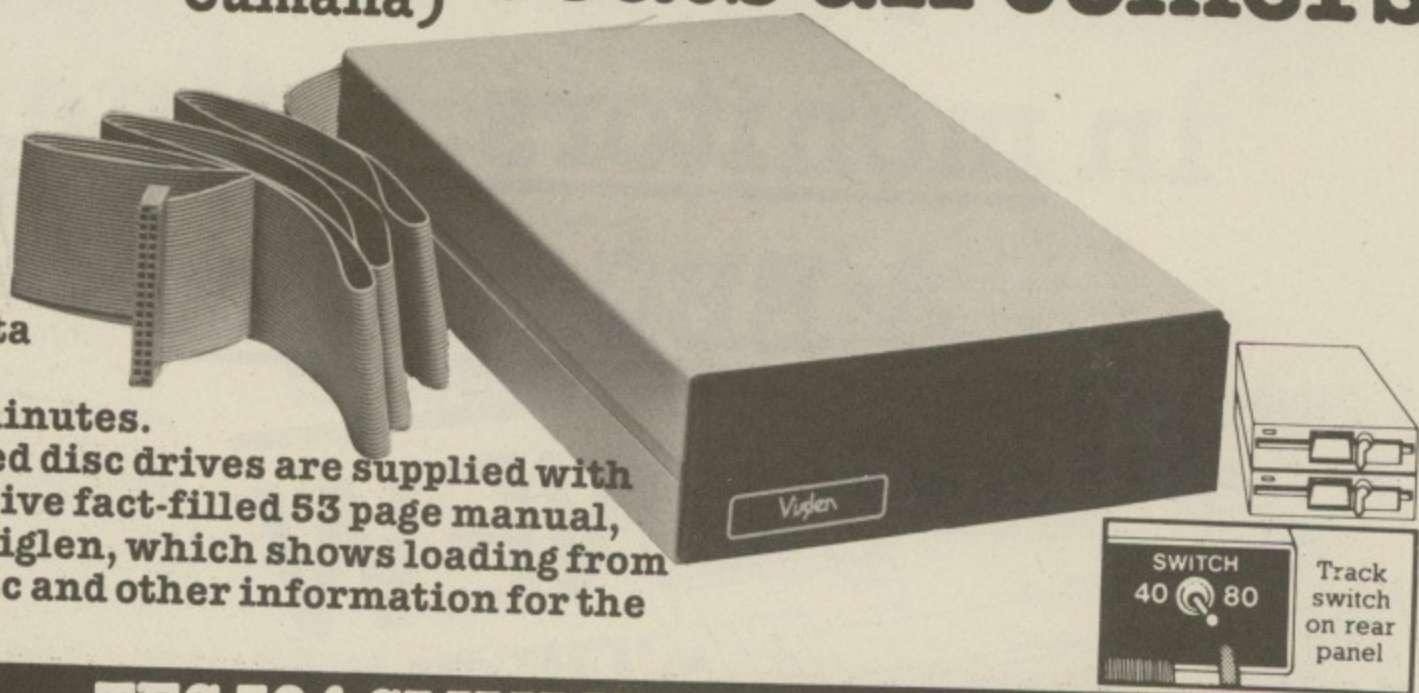

Our guaranteed disc drives are supplied with a comprehensive fact-filled 53 page manual, exclusive to Viglen, which shows loading from cassette to disc and other information for the BBC Model B.

TEC 504 SLIMLINE DRIVES

Single Drives	Incl VAT	Excl VAT	Dual Drives	Incl VAT	Excl VAT
40 Track 100K 5 1/4"	£119.00	£103.48	40 Track 200K	£238.00	£206.96
Single sided 40/80 track 200K switchable 5 1/4"	£139.00	£120.87	40/80 Track Switchable 400K 40/80 Track	278.00	£241.74
Double sided 40/80 track 400K switchable 5 1/4"	£179.00	£155.65	Switchable 800K	358.00	£311.30
Integral Power supply for single drive	£20.00	£17.39	Integral Power supply for dual drive	£40.00	£34.78
			ACORN Disc Filing System	£105.00	£91.30

Please Ring 01-843 9903 for LATEST PRICES

Viglen

COMPUTER SUPPLIES

Unit 7 Trumpers Way
Hanwell W7 2QA
Telephone: (01) 843 9903

All prices correct at time of going to press and all offers subject to availability. All disk drives are supplied complete with Professional Screened Case - Ribbon Cable to connect to BBC Micro - Power Cable to connect to BBC Micro - Comprehensive Manual - Formatting and utilities disc, which includes 13 useful utilities including * formatting * verifying * screen dump * dis-assembler * generating 62 files, etc.

Orders welcomed from Educational Establishments and Government Departments



Full Twelve Months Guarantee

How to order

By post: To purchase any of the items simply fill in the coupon with your requirements. Enclose your Cheque/P.O. or use your Access/Barclaycard. Please make cheques payable to VIGLEN COMPUTER SUPPLIES and post to above address. Allow seven days for delivery and add £8.00 carriage, package and insurance on all items.

By telephone: Ring (01) 843 9903. Credit Card holders (Access/Barclaycard only) can purchase by telephone. Please give Card No., Name, Address and the items required.

AMPLE ON-THE-SPOT CAR PARKING - AND IT'S FREE!
Post to: VIGLEN COMPUTER SUPPLIES UNIT 7, TRUMPERS WAY, HANWELL W7 2QA
Telephone: 01-843 9903. Personal Callers Welcome.
Please send me (state number required)
I enclose Cheque/P.O. for £ _____
I prefer to pay ACCESS/BARCLAYCARD (Delete whichever is not applicable)
Card No. _____
Signature _____
Name _____
Address _____
Incl. £8 carriage. Cheques payable to Viglen Computer Supplies.
Credit cards valid if signed by card holder. Address below must be the same as card holder.

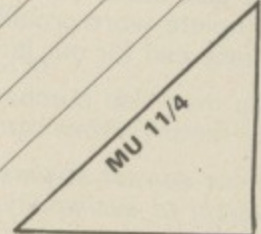

VIGLEN

gives you the best value
in monitors, printers
& BBC Micros

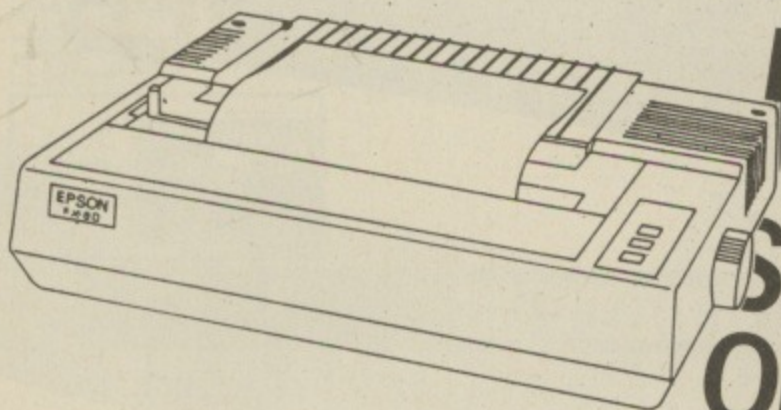

**NEW
SPECIAL
OFFERS**

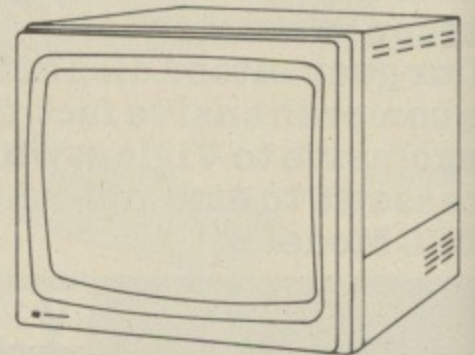

Dot Matrix Printers

inc. VAT ex. VAT

Canon PW 1080 A-KAGA-TAXAN

New printer recently reviewed shows near letter quality printing from dot matrix printer. Friction and tractor feeds. 160 cps. Highly recommended. **£289.00 £251.30**

Epson RX80/FT Brand leader. A reliable well established printer with friction and tractor feeds. 80 cps **£275.00 £239.13**

Epson FX80 The upmarket printer from the Epson range. 160 cps. All other facilities you would expect. Competitively priced at **£379.00 £329.56**

Shinwa CP80 **£199.00 £173.06**

Daisywheel Printers

inc. VAT ex. VAT

Juki 6100 **£375.00 £326.09**
SAN PLE 2000 **£229.00 £199.13**

Please add £8 for 1½ metre printer lead for BBC Micro

Please add £8.00 for carriage.

We also stock other computer peripherals, accessories and complete word processor systems at unbelievable prices. Please call for our latest offers.

You may also purchase these items direct by calling at our factory/showroom in Hanwell, West London.

Prices correct at time of going to press and offers subject to availability.

Colour Monitors

	inc. VAT	ex. VAT
Microvitec standard 1431	£189.00	£164.34
Microvitec medium 1451	£305.00	£265.20
Microvitec high 1441	£442.00	£384.34
Philips 4" TV/monitor (RGB Input)	£235.00	£204.34

Monochrome Monitors

inc. VAT ex. VAT

Philips 12" Green V2001 High-resolution **£75.00 £65.22**

BBC Micros

inc. VAT ex. VAT

Model B **£369.00 £320.87**
Model B + DFS **£459.00 £399.13**

**Please Ring
01-843 9903
for LATEST
PRICES**

AMPLE ON-THE-SPOT CAR PARKING - AND IT'S FREE!
Post to: VIGLEN COMPUTER SUPPLIES UNIT 7, TRUMPERS WAY, HANWELL W7 2QA

Please send me (state number required)
I enclose Cheque/P.O. for £
I prefer to pay ACCESS/BARCLAYCARD (Delete whichever is not applicable)

Card No. _____
Signature _____
Name _____
Address _____

Cheques payable to Vigen Computer Supplies
Credit cards valid if signed by card holder. Address below must be by post to the company.

MU11/5

NEW!

from

Viglen

COMPUTER SUPPLIES

A PRINTER STAND

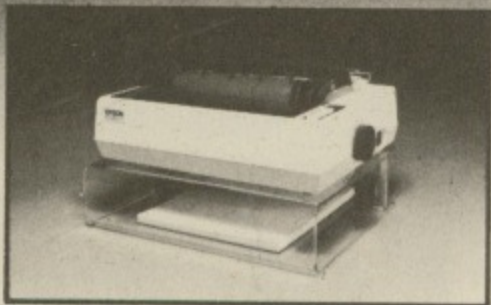
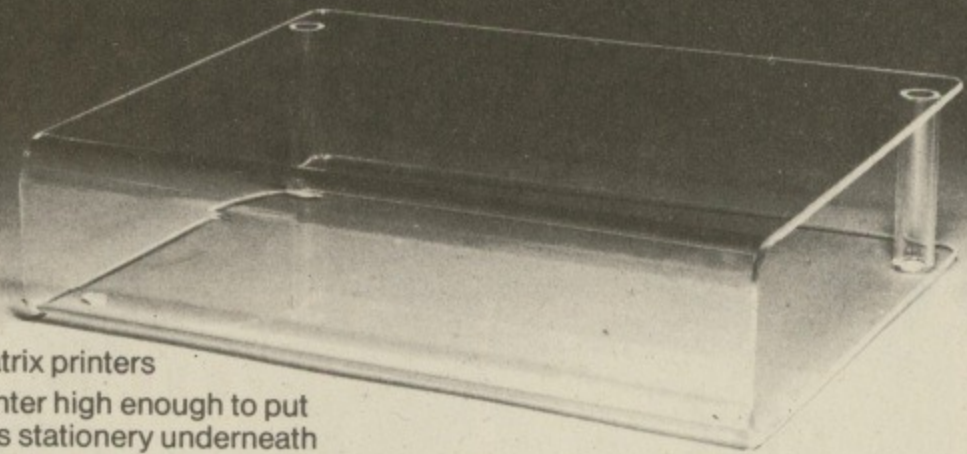

- For dot matrix printers
- Raises printer high enough to put continuous stationery underneath
- Beautifully finished in clear perspex • Viglen quality every time
- Will accept paper up to 12½" wide • Non slip rubber pads

Dimensions: 15" (380mm) wide 12½" (320mm) deep 4" (90mm) high

Printer Stand

£12.95 INC: VAT

Carriage & Packing £3.00

COME TO VIGLEN FOR A FAST, FRIENDLY, PERSONAL SERVICE

DEALER ENQUIRIES WELCOME

Post to: VIGLEN COMPUTER SUPPLIES, UNIT 7, TRUMPERS WAY, HANWELL, LONDON W7 2QA.

MU11/6

Please send me _____ (qty) PRINTER STANDS at £15.95 each. I enclose Cheque/P.O. for £ _____ made out to

VIGLEN COMPUTER SUPPLIES or debit my ACCESS/BARCLAYCARD No. _____

Name _____



Signature _____

Address _____

PHILIPS 14" COLOUR TV/MONITOR

£235 inc VAT

TV/Monitor (resolution better than 585 x 450 pixels. Dot-to-dot distance .65mm)

(TV only: £185 inc VAT)

As a company we chose the Philips because we believe it to have the clearest picture as well as being the best value. Take our word for it, or come and see for yourself.

EASY-ON-THE-SPOT PARKING. AND IT'S FREE!

Viglen

Plus £8 carriage and packing

COMPUTER SUPPLIES

Personal Service & Quality coupled with Wholesale Prices, Unit 7 Trumplers Way, Hanwell, London W7 2QA. Telephone: 01-843 9903.

For special attention to your orders or enquiries concerning MONITORS, PRINTERS, COMPUTERS, DISC DRIVES, ring 01-843 9903 NOW or fill in the coupon below.

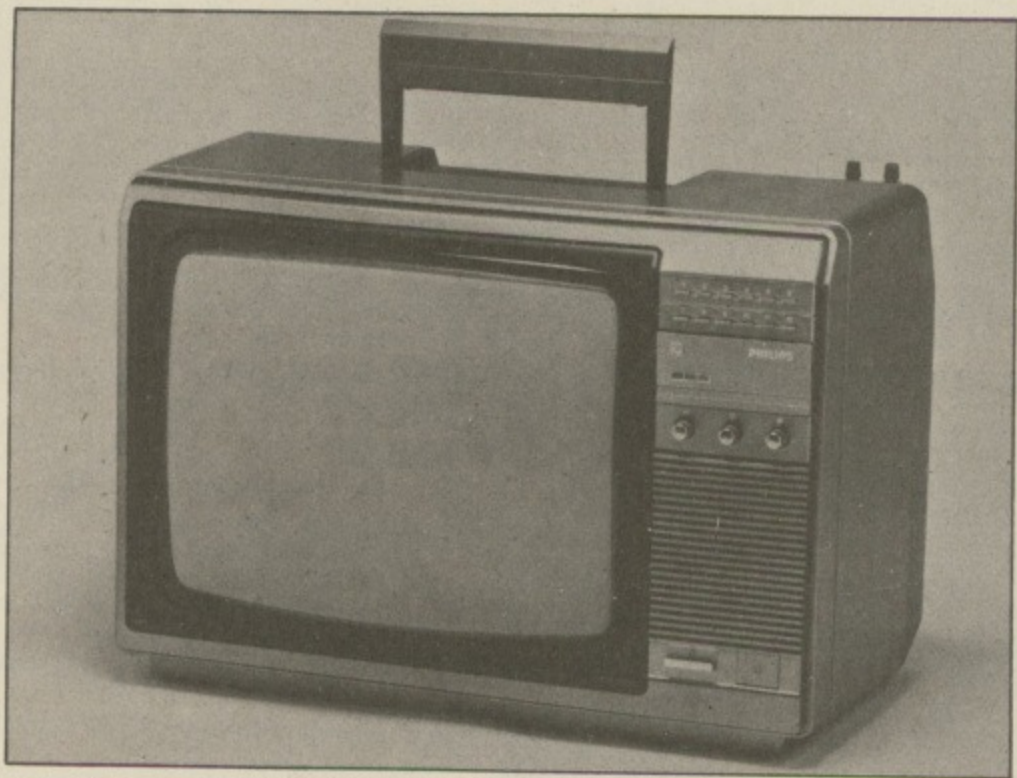

- Easy to carry • Lightweight • Sparkling picture in seconds • Reliability and performance excellent • Headphone Socket can also be connected to tape recorder • Loudspeaker mute switch • Retractable carrying handle
- Monitor/TV selected by switch • Includes RGB lead connecting direct to your BBC Micro. • Philips Model No. 14CT 2006/05T

Post to: VIGLEN COMPUTER SUPPLIES, UNIT 7, TRUMPERS WAY, HANWELL, LONDON W7 2QA.

MU 11/7

Please send me _____ (qty) Philips TV/Monitor at £243 each. I enclose Cheque/P.O. for £ _____ made out to

VIGLEN COMPUTER SUPPLIES or debit my ACCESS/BARCLAYCARD No. _____

Name _____



Signature _____

Address _____

NEW!

FROM Viglen



— Full Twelve Months Guarantee —

DISK STORAGE

No. 1

This diskette storage holds 70 diskettes

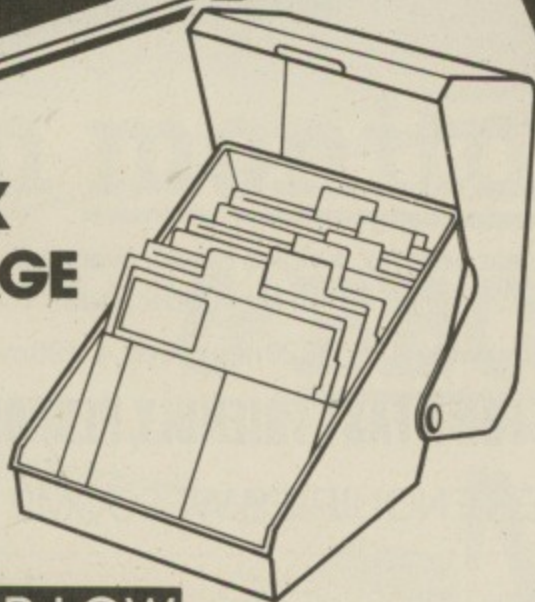

Our **SUPER LOW** price **£18.00** Including VAT

COMPUTER SUPPLIES

Unit 7 Trumpers Way Hanwell W7 2QA Tel: (01) 843 9903

DISK STORAGE

No. 2

This lockable diskette storage holds 80 diskettes

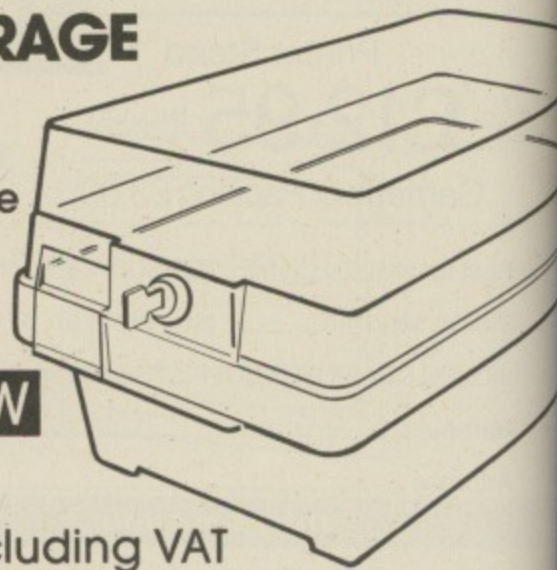

Our **SUPER LOW** price **£18.00** Including VAT

3M SCOTCH DISCS

5 1/4" diskettes single sided

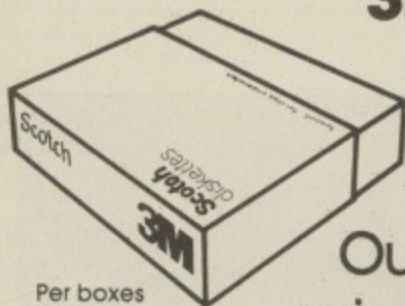

Per boxes of 10

boxes	1-2	3-9	10+
SS 40 TRACK	£15.00	£13.50	£13.00
DS 40 TRACK	£20.00	£18.40	£17.70
SS 80 TRACK	£23.00	£20.70	£20.00
DS 80 TRACK	£26.70	£24.00	£23.00

Our **SUPER LOW** prices Inc.VAT

PERSPEX KEYBOARD STOWAWAY & VDU STAND

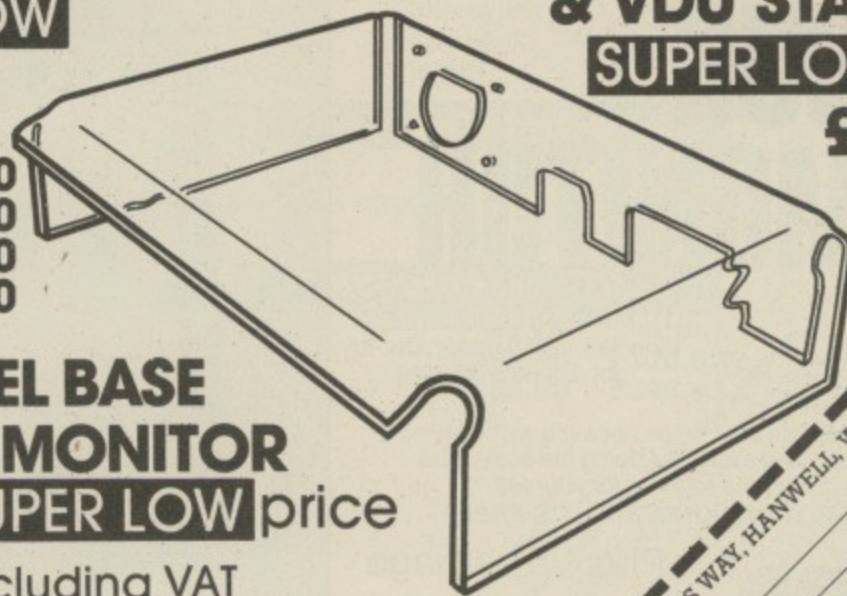

Our **SUPER LOW** price **£14.95** Inc VAT



SWIVEL BASE FOR MONITOR

Our **SUPER LOW** price **£16.00** Including VAT

GRAFPAD Our **SUPER LOW** price **£143.75** Including VAT



This remarkable Grafpad from British Micro allows you to input information into your computer - very accurate and high resolution, not to be confused with other models which are both more expensive and less accurate. Supplied with all necessary cables, manual and sample programs, to allow you to develop your own application programmes.

AMPLE ON-THE-SPOT PARKING. AND IT'S FREE!
 Post to: VIGLEN COMPUTER SUPPLIES, UNIT 7, TRUMPERS WAY, HANWELL, W7 2QA. Tel: 01-843 9903

Please send me the following items:
 I enclose Cheque/P.O. for £
 I prefer to pay by ACCESS/BARCLAYCARD* Card No:
 Signature
 Name
 Address

All items £2.00 only for P & P

MU1178

When
 whet
 you'r
 TAXA
 micro
 Com
 Mach
 (with
 made
 There
 availa
 VISIO
 RGB
 smoke
 and/o
 VISIO
 Displa
 Equip
 switch
 Availa

One name stands out for quality and value



When you choose a TAXAN monitor from Kaga, whether it's monochrome or RGB colour, you're choosing the best.

COMPATIBILITY

TAXAN monitors are compatible with all popular micro computers. Apple™, Acorn/BBC™, IBM™, Commodore™, Oric™, Dragon™, Research Machines™, Osborne™, Tandy™, Sinclair™ (with interface) – you name it, KAGA TAXAN's made for it.

COLOUR RANGE

There are several TAXAN Colour Monitors available from around £200 to £399, including:-

VISION EX (Resolution: 380 dots) – PAL or RGB input – Built-in Speaker – Equipped with smoked filter – Ideal display for Computers and/or Video Recorders.

VISION II (Resolution: 510 dots) – RGB Colour Display – Capable of 80 column display – Equipped with smoked filter – Built-in switchable interface.

VISION III (Resolution: 640 dots) – RGB Colour Display – Suitable for 80 column display – Utilises latest matt black non-glare tube – Built-in switchable interface.

VISION PC – IBM compatible version of the Vision III in 'IBM style' casing.

MONOCHROME RANGE

NEW: THE KX SERIES of monochrome monitors from around £100 – 12" non-glare flat screen – Green or Amber display – More than 20 MHz – Built-in handle – Optional 'tilt and swivel' stand – IBM PC™ compatible versions available.

RELIABILITY

TAXAN monitors are among the most reliable displays around, and are backed by a full 12 months' warranty.

TAXAN IS THE NEW BRAND NAME FOR PRODUCTS MANUFACTURED BY KAGA ELECTRONICS CO. LTD.

All prices ex-VAT and correct at time of going to press.

NLQ DOT MATRIX PRINTERS

NEW

TAXAN
 KP810 (£299)
 (80 col. model)
 KP910 (£399)
 (156 col. model)
 – 140 cps and near-letter quality (NLQ) print.
 – Supported by all popular software.
 – High resolution graphics.

RING 0442 60155 FOR DETAILS

TRADE AND OEM ENQUIRIES WELCOME.

Available from your local computer dealer; selected branches of W.H. Smith, Lasky's, Curry's and other leading retailers. EXCLUSIVE UK DISTRIBUTOR.

DE

Data Efficiency Ltd

Whatever your system... insist on KAGA TAXAN

Computer Peripherals Division. Maxted Road, Hemel Hempstead, Herts. HP2 7LE Tel: (0442) 60155 (14 lines) Telex: 825554 DATEFF G

Available at selected
Spectrum (UK) and other
leading computer outlets.



**MAKE THE BBC
AN EXPERT AT
COMMUNICATIONS.**

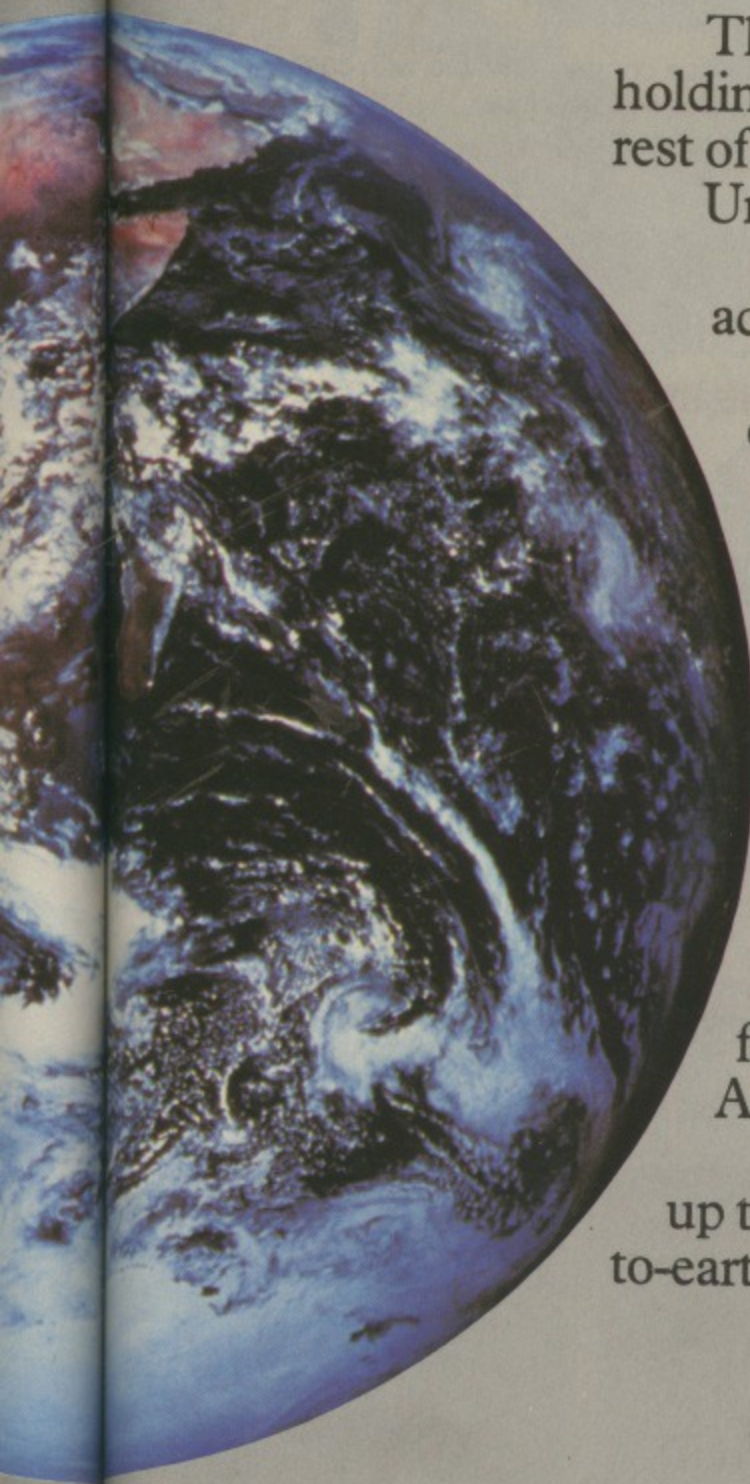

The BBC Micro is unbeatable when it comes to holding your attention. But when it comes to talking to the rest of the outside world it's virtually speechless.

Until, that is, you speak to us.

In which case you and your BBC could soon be accessing viewdata systems throughout the country.

By simply linking your BBC into our purpose-designed communications and viewdata system you dramatically increase the capability of your micro. Allowing you to keep in touch with your friends. And to get answers within minutes to electronically mailed letters. You can even try your hand at the latest adventure games on Micronet 800 (as well as looking at the news, reviews, prices and best-buy information).

In addition to all this, you will also be able to access Prestel. A vast database of news and information. Helping you to book tickets for your favourite concerts. Plan your road and rail trips. And even check the weather forecast before you go.

Our communications and viewdata systems open up the world to you and your micro. And at a down-to-earth price - with systems starting from under £90.

So, if you're keen to contact the outside world... simply contact us.

APPROVED for use with telecommunication systems run by British Telecommunications in accordance with the conditions in the instructions for use.

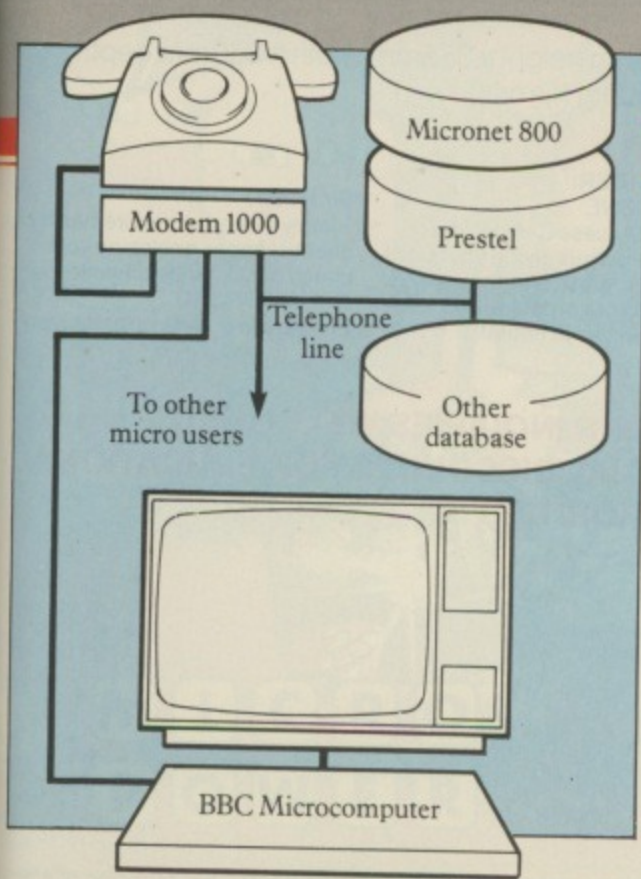

Prism Microproducts Ltd.
Prism House, 18-29 Mora Street
City Road, London EC1V 8BT
Telephone: 01-253 2277



Please send me further details of the Prism viewdata communications system for the BBC Micro. Send to: Prism Microproducts Ltd., Prism House, 18-29 Mora Street, City Road, London EC1V 8BT.

Name _____

Address _____

Tel: _____

AP6

Prestel and the Prestel symbol are trademarks of British Telecommunications.

GRAFPAD

...for as many uses
as YOU
can imagine!

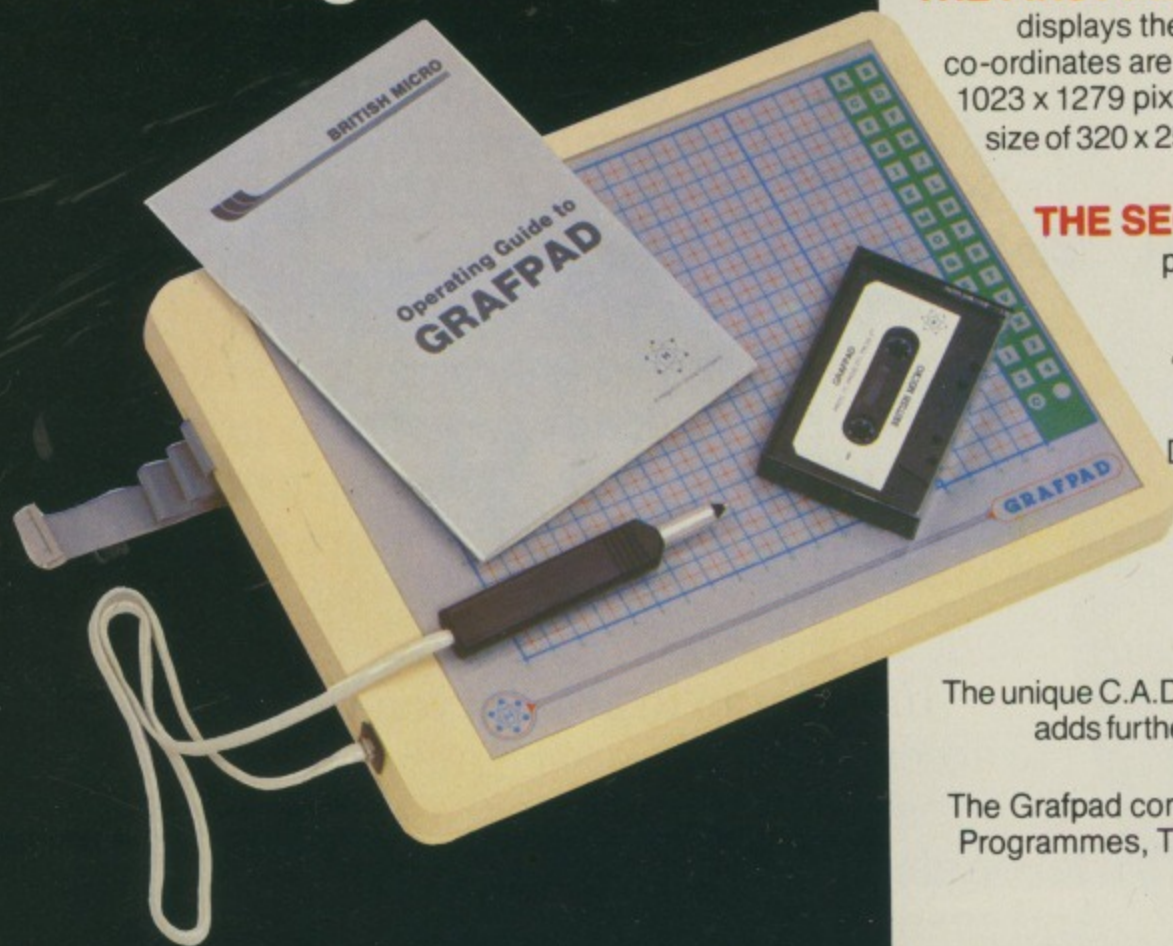

BBC MODEL B • SPECTRUM COMMODORE 64

With Grafpad you can now add a new dimension to your computer enjoyment, but most important, it helps you create your own application programmes by the simple use of the Grafpad!

The BBC Grafpad comes complete with cassette and disc comprising of three programmes.

THE FIRST PROGRAMME

displays the co-ordinates of your screen area. The co-ordinates are based on the screen with a grid size of 1023 x 1279 pixel, also in the Grafpad giving you a grid size of 320 x 256 pixels! This is to allow you to write your own graphic programmes.

THE SECOND PROGRAMME

provides you with the utilities for circles, squares, triangles, free-hand, erasing, line-drawing etc, and of course, a "Fill-in" facility in 16 different colours by the simple use of the pen.

Draw from a simple apple to a computer circuit - store in cassette or disc, perhaps transfer direct to printer - in black and white or full glorious colour.

THE THIRD PROGRAMME

The unique C.A.D. (Computer Aided Designs) programme adds further enjoyment and professionalism to your computer designs.

The Grafpad comes complete with Operational Manual, Programmes, The Grafpad and Pen and it simply plugs in your computer.

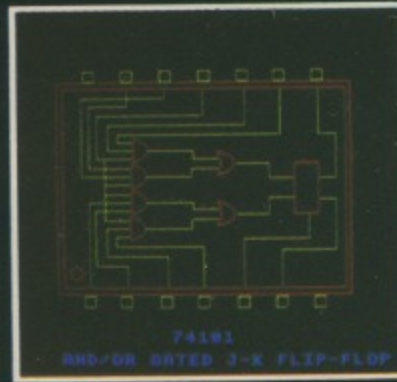
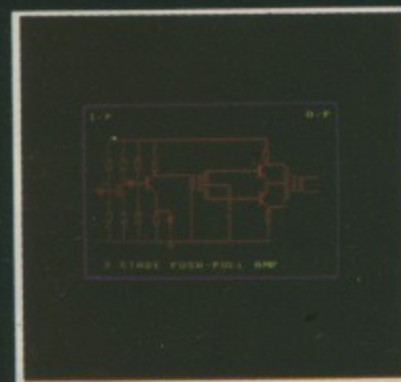
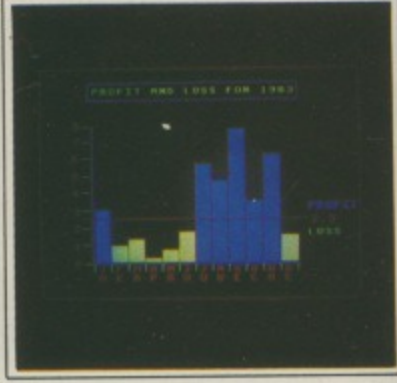
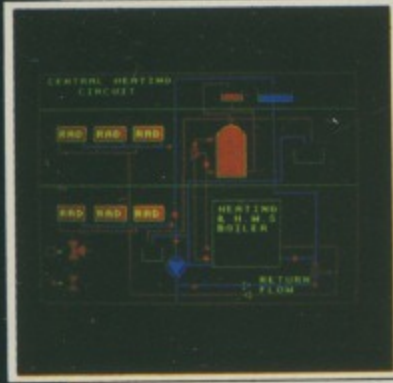
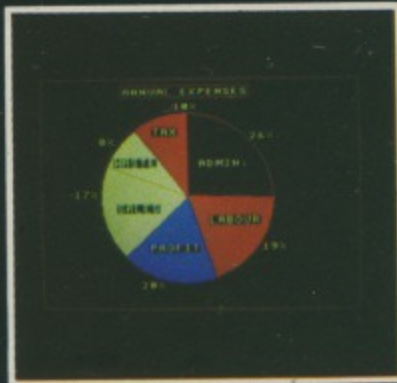

(The above designs were drawn by a 12-year-old at our showrooms!)

(Size: 25mm height x 355mm width x 260mm depth)
Weight: 1.2kg (Gross)

HOW TO ORDER:

BY TELEPHONE:
If you are an Access Card Holder simply telephone us giving your Card No., Name, Address and item(s) required and your orders will be dispatched within 48 hours!

BY POST:
Simply fill in your requirements on a sheet of paper, enclosing your cheque/P.O. made payable to: BRITISH MICRO. Please allow 14 days for delivery.

- DEALER INQUIRIES WELCOMED
- SPECIAL DISCOUNTS FOR EDUCATIONAL AUTHORITIES

BRITISH MICRO

A HEGOTRON GROUP COMPANY

Unit Q2, Penfold Works, Imperial Way, Watford,
HERTS WD2 4YY
TEL: (0923) 48222.
TELEX: 946024

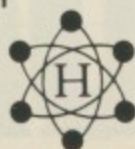

POWER MICRO POWER MICRO POWER MICRO



\$wagg

FROM THE AUTHOR OF THE TOP SELLING FELIX IN THE FACTORY

B.B.C. MICRO electron

A two player game of dexterity set in Hazard County. Beat your opponent to the jewels and gold with the help of your band of cronies. Includes police cars and one player practise option.

(BBC version: joystick & keyboard control).
Cassette: £6.95.
Disk: £9.95.



"WATCH OUT FOR THE FANTASTIC NEW PACKAGING!!"

MICRO POWER LTD.,
NORTHWOOD HOUSE, NORTH STREET,
LEEDS LS7 2AA TEL: (0532) 458800
MICRO POWER SOFTWARE IS AVAILABLE FROM
SELECTED BRANCHES OF WH SMITH, BOOTS, JOHN
MENZIES, CO-OP, WOOLWORTHS AND ALL GOOD
DEALERS.
AUTHORS! WE PAY 20% ROYALTIES!

MICRO
POWER



BLOCKBUSTER



FOR reasons that are not clear to him, Seamus, the energetic little green man, has been transported into a vast maze with no way out.

His only hope of survival is to align the three magical diamond blocks before time runs out and he becomes victim of the freak phenomenon "spontaneous combustion".

Seamus can push blocks by running into them. This does not sap his energy but renders him immobile until the blocks have stopped moving.

By holding down Return Seamus enters "Blast mode" and can explode any obstructive block he runs into at a cost of 10 units of energy. Diamond blocks are indestructible.

With these powers the task may seem easy. But Seamus is not alone in the maze. Pursuing him relentlessly are the Gremlins. If Seamus meets one, energy plummets as he grapples with the beast.

The persistent Gremlin can be dealt with in two ways. Pushing a block over one will squash him. Tamer species of Gremlin can be lured into corners and trapped.

However if Seamus should align the diamond blocks he is transported to a new, more exhausting maze with a wilder, nimbler species of Gremlin, some of whom can penetrate any wall.

If one of these Gremlins is squashed he soon pops up again elsewhere in the maze.

Points are awarded for:

- Time remaining when the diamond blocks are aligned. (They must be pushed into a line. Pushing them into a clump will not do).
- Squashing the Gremlin. Ten energy units are awarded for this.

Quick thinking and a keen sense of engineering are essential in this mind-stretching, action-packed game.

Are you a Blockbuster?

Align the magical diamond blocks or become a victim of spontaneous combustion in this fast maze game by
MARK MELFORD

PROGRAM STRUCTURE

Lines 160-200
PROCBLOCKS
PROCMEGGA
PROCBOX
PROCEGE
PROCKEYS
PROC MAN
PROCGREM
PROC CHECK

PROCTHINK
PROCSHOVE
PROC MOVE
PROC SCORE
 Lines 820-890
PROCCALLS

PROCLINE
PROCLINE B
PROCWIN
PROCFANFARE
PROCBANG
PROCSHATTER
PROCDOT
PROCBumped
PROCRESTORE

PROCSQUASH
PROCTOUCH
PROCTOUCED
PROC MC
 1760 onwards

Main loop.
 Prints ice blocks.
 Prints diamond blocks.
 Prints big yellow boxes.
 Draws screen border.
 Checks for keyboard entry.
 Prints appropriate pose of Seamus.
 Prints appropriate species of Gremlin.
 Checks to see whether the Gremlin has collided with anything.
 Decides on the direction a pushed block will move in.
 Moves the pushed block.
 Calculates Seamus's position each time it is updated.
 Prints up score, energy and time.
 Handles end of game and restarting.
 Calls checking routines for all possible alignments of three diamond blocks.
 Horizontal checking.
 Vertical checking.
 When screen is successfully completed.
 Plays tune at start of each screen.

Block explosion.

Action if Gremlin is hit by moving block.
 Handles actual death by splatation of Gremlin and resetting of variables thereafter.
 Displays the gory detail.

Decides whether Gremlin has been hit.
 Machine code to speed up the shape plotting slightly.
 Initial fanfare and controls display Sets up VDUs and envelopes. Deleted before game starts.

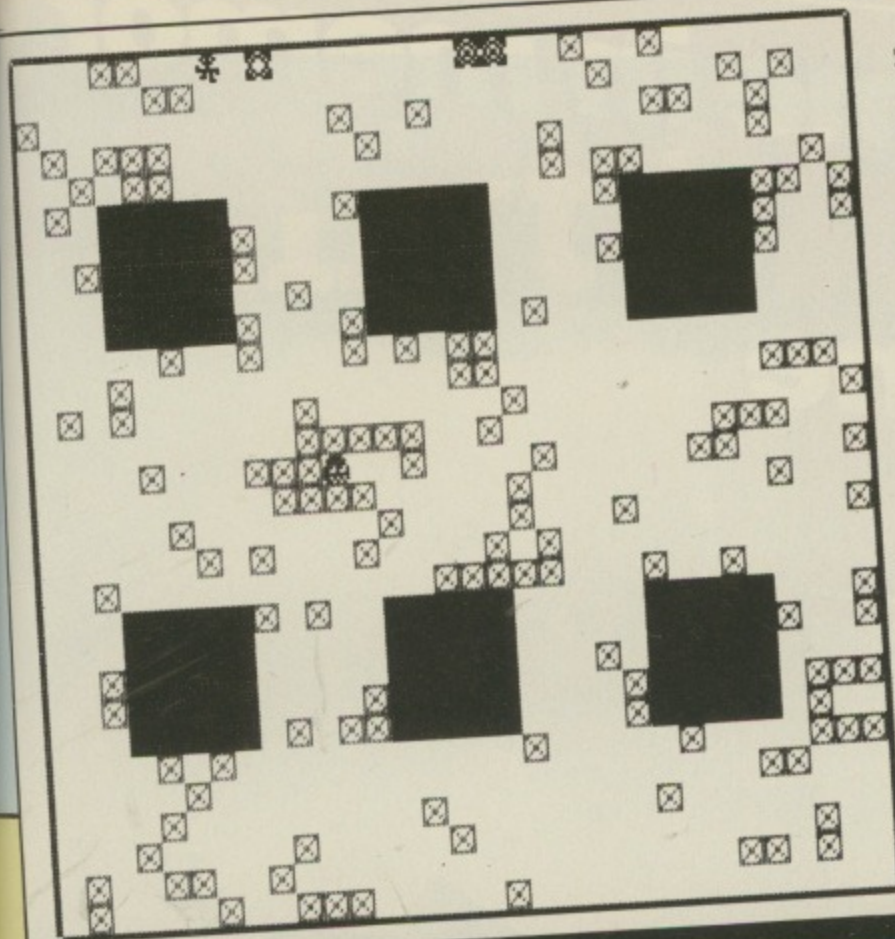

SHEET

1

ENERGY

100

TIME

1100

SCORE

400

HIGH

10000

VARIABLES

- X% Seamus X coordinates on screen.
- Y% Seamus Y coordinates on screen.
- M% Seamus shape (224 or 225) identifies VDU.
- A% Gremlin X coordinates on screen.
- B% Gremlin Y coordinates on screen.
- V% Gremlin X and Y step size if he collides with anything.
- W% Direction at block once pushed.
- C% Colour of moving block (diamond or ice).
- D% 1, 2, 3 or 4 depending on direction Seamus is moving.
- E% Remaining energy.
- MV% Step size at Gremlin.
- SC% 1 when tune is playing.
- ET% Screen number.
- CV% Step size of particles of an exploding block.
- DAT% Your score.
- SS% 9 when a screen is completed.
- PT% Amount of time and energy decrease by each new screen.
- LOP% Ascii code of Block.
- BOP% Ascii code of Gremlin.
- &70 Ascii code of Seamus.
- &71 Gremlin shape (similarly to M%).
- &72 Time.
- @% 1 if Seamus is in Blast mode.
- TI% Added to X%, Y% respectively and used with POINT to find out if Seamus touches a block.
- HIT% Used to find out if Gremlin is touching Seamus.
- Q% Coords of moving block.
- R% Number of diamond blocks correctly aligned horizontally. If three then screen completed.
- GX% Number of diamond blocks correctly aligned vertically.
- HX% Used to find whether a moving block has struck the Gremlin.
- GY%
- HY%
- F%
- G%
- JJ%
- SJ%
- AF%
- AG%
- BF%
- BG%

```

5 REM BLOCKBUSTER
6 REM (c) Micro User
10 GOTO1760
20 VDU21
30 *FX138,0,129
40 END
50 VDU6:DIM HI(2):HI(1)=10000:CLS:
PRINT:PRINT"  Press Space or Fire"
60 IFINKEY(-99)THENGOTO80
70 GOTO60
80 MODE1
90 *FX9,5
100 *FX10,5
110 XX=328:YY=320:MX=224:AZ=648:BX=
512:VZ=8:WZ=8:CZ=0:DX=0:EZ=0:NVZ=1:SC
X=500:ETX=8:CVX=1:DATX=0:SSX=8:E1X=FX
+16:F1X=YZ-16:E2X=FX+16:E3X=FX+16:F2X
=YZ-16:E4X=FX+16:BVX=0:PTX=100:LOPX=0
:BOPX=0:BAGX=1:7&71=234:7&70=227:7&72
=224:0X=234
120 VLX=1:JIKX=0:VDU5,19,1,5;0;19,2
,3;0;19,3,2;0;23;8202;0;0;0;:PROCNC
130 PROCBLOCKS:RESTORE:SCX=500-BOPX
:VDU4:COLOUR1:PRINTTAB(34,2);"SHEET":
PRINTTAB(34,8);"ENERGY":PRINTTAB(34,1
4);"TIME":PRINTTAB(34,20);"SCORE":PRI
NTTAB(34,26);"HIGH":COLOUR3:PRINTTAB(
34,4);BAGX:PRINTTAB(34,28);HI(1):LOPX
=0
140 PROCSCORE(SCX,34,10):PROCSCORE(
PTX,34,22):6COL3,3:MOVE328,320:VDU224
:6COL3,2:MOVE648,512:CALL T:PROCEGE:
FORLPX=104TO804STEP320:PROCBX(LPX,67
6):NEXT:FORLPX=104 TO 804STEP320:PRO
CBX(LPX,228):NEXT:PROCMEGGA:CVX=1
150 TIX=10000-(10*BOPX):PROCSCORE(T
IX,34,16)
160 PROCCKEYS
170 PROCGREM
180 IFCVZ=1THENPROCFANFARE
190 IFLOPX=9THENGOTO130
200 GOTO160
210 DEFPROCBLOCKS:LOCALXZ,YZ:6COLO,
1:FORLPZ=0TO200:XZ=RND(992/32):YZ=RND
(960/32):MOVEXZ*32+8,YZ*32+32:VDU227:
NEXT:ENDPROC
220 DEFPROCKEYS:HITX=0
230 IFINKEY(-74)THENHITZ=1
240 IFINKEY(-98)THENMVZ=1:QZ=-4:RZ=
0:PROCMAN:PROCMOVE(-32;0):MZ=MZ+1:PRO
CMAN
250 IFINKEY(-67)THENMVZ=2:QZ=32:RZ=
0:PROCMAN:PROCMOVE(32,0):MZ=MZ+1:PRO
CMAN
260 IFINKEY(-73)THENMVZ=3:QZ=0:RZ=4
:PROCMAN:PROCMOVE(0,32):MZ=MZ+1:PROCM
AN
270 IFINKEY(-105)THENMVZ=4:QZ=0:RZ=

```

Turn to Page 172

The best name in memory is now also the best name on record...

You no doubt know our name for disk drives. We've spent years on research, development and marketing a range of drives second to none. A logical extension for us was to introduce diskettes. Only when we found a 5¼" double density diskette up to our stringent quality control requirements, and at a price that made sense to the end user, were we ready to put our name to it.

This is the result, a diskette of top quality, complete with a plastic protective case for the ten-pack (we also sell them individually!) together with index stickers.

Cumana diskettes are available now, as single or double sided 40 or 80 track, from your local computer dealer. Don't trust it to chance, go for the best name in memory . . .



Cumana Ltd., Pines Trading Estate, Broad Street,
Guildford, Surrey, England, GU3 3BH.
Tel: Guildford (0483) 571666. Telex: 859380.



Ain't She Sweet



AND WITH A VERY TRIM LITTLE FIGURE £159.00 (inc. VAT, Postage and Packing)

The Bevan Nymph 3-inch Compact Floppy Disk Drive is tailored for use with your BBC Micro and is compatible with all disk interfaces and comes complete with cables, comprehensive manual and utilities disk.

The Nymph has been developed by Hitachi and its rotation speed, data transfer rate, recording capacity per track and other specifications are designed to be the same as those of the conventional 5.25-inch drives and is therefore, fully compatible.

The Nymph is available either as a flipable unit with a storage capacity of 100K each side or as a double sided unit allowing access to either side of the disk without removal. It can be purchased either as a single or double drive unit with or without power supply thus enabling you to choose between using the BBC's power supply or utilising its own.

Prices quoted are inclusive of VAT, postage and packing.

RANGES AVAILABLE

- ★ ST1 Single Flipable £159.00
- ★ ST2 Single Non-Flipable £199.00
- ★ ST3 Single Flipable with PSU £179.00
- ★ DT1 Dual Flipable £269.00
- ★ DT2 Dual Non-Flipable £359.00
- ★ DT3 Dual Flipable with PSU £319.00

DISKS

Double Sided (100K × 2) at £4.75 each
OR pack of five £22.00
**DEALER ENQUIRIES
WELCOME**

FEATURES

1. Compact and lightweight: Almost half the volume and weight of the "Mini Floppy Disk Drive."
2. One-touch disk load/unload.
3. Hardened plastic center hub for improved reliability.
4. Rigid compact floppy-disk case with automatic head-window shutters for media protection.
5. Low power consumption: Almost half that of the "Mini Floppy Disk Drive".
6. Brushless direct drive motor: Highly reliable, brushless direct drive motor offers longlife operation.
7. High-performance head-access mechanism using step motor and steel band.
8. Narrow write and wide read heads with a tunnel erase head using Mn-Zn ferrite.
9. 12 month warranty.

BEVAN TECHNOLOGY - A NAME TO LOOK OUT FOR

To: Bevan Technology Ltd, Gresham Chambers, 14 Lichfield Street, Wolverhampton, West Midlands WV1 1DG. Tel: 0902 23546

Please supply: _____ Qty _____

I enclose my payment of £ _____ Disks _____

Name _____

Address _____

Post Code _____

Tel. No. _____

Date _____



COMPUTING

SPECIAL AUTUMN PRICES

Price Ex-VAT

DISK DRIVES

3" Mini Floppy 100K Disk Drive
(Cased with Leads and Utilities Disk) **£105.00**

5 1/4" TEC 100K Disc Drive **£105.00**

PRINTER

NEC 8023 80 Dot Matrix Printer **£199.00**

MICROCOMPUTERS

Acorn Electron (with 2 free software packs – whilst stocks last) **£173.04**

BBC Model B (with free cassette recorder and
3 software packs – whilst stocks last) **£347.00**

MONITOR

DECCA 1231 Colour Monitor **£190.00**

GSL's Product Range Includes:

Winchester Hard Disk System · Cartridge Drives for backup · 64K
Printer Buffer · Low Speed Logic Analyser · Real Time Calendar
Clock · Analogue Signal Analyser · Alternative Keyboard Display
Rack Mounting System

I would like to order:
(Please tick)



- 3" 100K DISK DRIVE
- 5 1/4" 100K DISC DRIVE
- NEC PRINTER
- ACORN ELECTRON
- BBC MODEL B
- DECCA MONITOR
- Send me information on your product range

(Cheques made payable to G.S.C.L.)

Or Phone LEA WYATT ON ANDOVER (0264) 59633

NAME _____

COMPANY _____

ADDRESS _____

Tel: No. _____

Return to:
LEA WYATT GSCL
WEST PORTWAY, ANDOVER,
HANTS SP10 3SG

MU11

How to blow your own violin...

HAVE you noticed how smug your computer can be? I mean, you type in something like PRINT 2/PI and before you have taken your finger off the Return key the damn thing has printed out the answer and is ready for more.

Well, now we'll show it who is boss, as the computer will have to earn its corn.

We will use last month's D/A converter to enable the computer to recreate the sound of any musical instrument – and even to invent your own.

Last month we saw how we could generate any waveform from the D/A converter. We could specify that waveform as a sum of harmonically related frequencies to produce different sounds, rather like an organ pulling out more stops.

However the range of pitches that

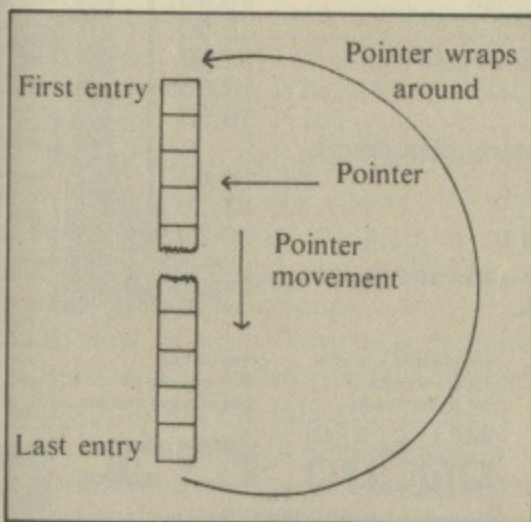

Figure 1: Waveform lookup table

By MIKE COOK

could be produced was limited and the notes could not be made to sound like blown or bowed instruments, like a trumpet or violin. Now I know that a blown violin is a very rare sound but it can be made!

Let's see how to overcome those problems with software alone.

To produce a note we need a lookup table in memory containing the amplitude of the waveform at each sample period. This is shown in Figure I.

We move a pointer through the table fetching the contents of each entry and sending them to the D/A converter. When the pointer reaches the end of the table it wraps around or starts again at the beginning.

As the table represents one cycle of a tone, in order to get tones of different pitch we must complete the scan of the table in different times.

We saw last month that this could be done by varying the time between each sample. However this does not provide very fine control, as the computer cannot operate fast enough.

To generate a 1KHz tone with 256 samples we would need to fetch a sample every four microseconds. This is much faster than most computers can cope with.

In addition the time could not be varied finely enough to be able to

generate the exact pitch on a musical scale.

Well, if we can't vary the sample time, the solution is not to take every sample in the table. However if we get every other sample we will double the frequency and not be able to get anything in between.

The solution is to step through the table, not in an integer fashion but in a fractional way. At first sight this appears to be impossible as the table entries are at integer positions.

But if we have the pointer as a fixed point decimal number and use only the whole part of the number to access the table, we can then move the pointer a fractional amount and finely control the time it takes to scan through a table.

So we need a pointer and a pointer increment value both stored in two bytes – an integer part and a fractional part.

How can we represent a fraction in a binary fashion?

To represent an integer we assign each binary bit a power of two. To represent a fraction each bit to the right of the decimal point – I should really say binary or bicimal point – represents a negative power of two.

Figure II shows this along with the decimal equivalent of the significance of each bit. You can see that simple decimal values like 0.3 will need a lot of bits to represent them accurately.

In fact some decimal values require

$2^{\uparrow-1}$	$2^{\uparrow-2}$	$2^{\uparrow-3}$	$2^{\uparrow-4}$	$2^{\uparrow-5}$	$2^{\uparrow-6}$	$2^{\uparrow-7}$	$2^{\uparrow-8}$	Power
0.5	0.25	0.125	0.0625	0.03125	0.015625	0.0078125	0.00390625	Value
7	6	5	4	3	2	1	0	Bit

Figure II: Binary fraction

M I C R O P O W E R M I C R O P O W E R M I C R O P O W E R



GET ON THE RIGHT TRACK WITH MICRO POWER



Micro Power are an official service and information centre, and we are major suppliers to Government and educational establishments. We stock the complete range of Acornsoft and Micro Power software as well as a wide range of B.B.C. Micro and general computing books. Our expert staff are always on hand to provide advice and assistance in the relaxed atmosphere of our showroom.

COMPUTERS

AUTUMN SPECIALS	
B.B.C. Micro + Cassette Recorder AND Five Micro Power or selected Acornsoft Tapes	399.00
B.B.C. Model B plus DFS + 4 tapes	469.00
B.B.C. Model B plus Econet + 4 tapes	446.00
B.B.C. Model B plus DFS and Econet	516.00
Acorn Electron + Cassette Recorder OR Five Micro Power Tapes	199.00

MONITORS

Kaga 12" Green Screen	123.05
Ferguson TX Monitor/TV	264.50
Sanyo DM2112 12" Green Screen	74.95
Microvitec 14" RGB/PAL and audio output	258.75
Microvitec monitor (plastic)	228.85
Microvitec monitor (metal)	228.85
Microvitec medium resolution monitor	299.00

DISK DRIVES

Pace 40 track 100K	156.40
Pace 40 track double sided 200K	220.80
Pace 40/80 track double sided 200/400K	241.50
Pace 40 track dual drive 200K	310.50
Pace 40 track double sided dual drive 400K	434.70
Mitsubishi 40/80 track double sided dual drive 400/800K	567.85
Torch Z80 Disk Pack 80 track double sided dual drive (including Perfect software)	803.85
AMS HFD 3055 3" 100K	169.00

ALL PRICES INCLUSIVE OF V.A.T.
We provide free fitting for all firmware.
ALL ROADS LEAD TO MICRO POWER!

PRINTERS

Epson FX80	416.40
Epson RX80 F/T	268.90
Juki 6100 Daisywheel	415.00
Smith Corona TP-I daisywheel	270.20
Cannon PW1080	332.58

ACCESSORIES

Acorn B.B.C. cassette recorder (inc. leads)	35.00
Morwood B.B.C. cassette recorder (inc. leads)	29.95
Sureshot self-centering arcade joystick	18.22
Micro Power potentiometer joystick	12.95
Acorn Disk Interface	115.00
Pace Modem	136.85
Commstar ROM	34.00
1.2 ROM upgrade	11.50
Speech synthesiser plus cartridge socket (Free 1.2 ROM if required)	55.00
View wordprocessor ROM	59.80
Wordwise wordprocessor ROM	45.42
Quickshot II Joystick	12.95
Electron Plus 1 printer/joystick interface	59.90
First Byte Electron joystick interface (including cassette)	24.95
ATPL sideways RAM board	45.00
Teletext adapter (Free 1.2 ROM if req.)	225.00
Softlight EPROM programmer	75.90
Printer cables (parallel or serial)	15.50
3M unlabelled disks (ten)	15.00
Scotch D/S D/D disks (Box of ten)	32.50
Maxell 3" disk	4.95
Disk storage case	19.95
Vinyl dust cover for computers, disk drives, monitors and printers	4.50
Stack light pen	28.75
Tutor Mate Monitor stands	10.50

Wide selection of computer leads and printer ribbons in stock.

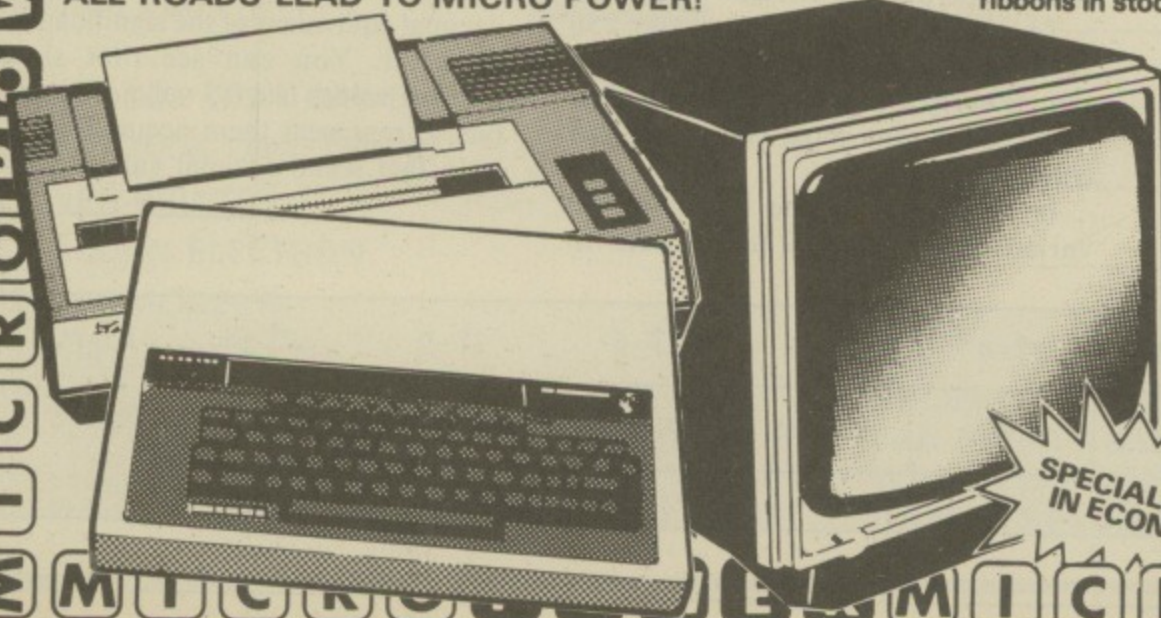

*HP facilities available. Please contact us for further details.

*Free parking. All prices correct at time of going to press.

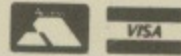

Showroom: MICRO POWER LTD., Northwood House, North Street, Leeds LS7 2AA; Tel: (0532) 458800
Mail Order: MICRO POWER LTD., DEPT. AU11, Sheepscar House, Sheepscar Street South, Leeds LS7 1AD; Tel: (0532) 434006

Send an SAE for our complete listing of hardware, software and books.

CARRIAGE FREE for ALL hardware
Books and software only 55p per order
U.K. Mainland Only

SPECIALISTS IN ECONET

M I C R O P O W E R M I C R O P O W E R M I C R O P O W E R

From Page 105

an infinite number of bits to represent them. Nevertheless we only need one byte for our purposes.

The great advantage of representing a number in this format is that the normal addition operation works just the same as if it were a two byte integer.

Therefore by specifying the correct incremental fraction we can tailor exact frequencies.

Of course the number of samples per waveform is lower than it would normally be, but due to the wrapping round of the pointer each traverse through the table takes a different set of samples from the last.

Overall the ear is fooled and the reduced resolution of sampling is hardly noticed.

The only requirement is that at least two samples must be taken per traverse of the table to prevent aliasing from occurring. This would produce low frequencies which sound discordant.

If the waveform table contains more than one cycle of a waveform at least two samples of each cycle of the waveform must be taken.

Aliasing is a product of sampling a waveform. Supposing you sampled a waveform at exactly the same point each time, the output would appear to be a steady DC level.

Now suppose that you sampled the waveform at just longer than its period, then you would sample it at a progressively later point in each cycle, resulting in a frequency related not to the original table but to the sampling rate.

I am sure you have all seen examples of this, such as in old cowboy films where the wheels of the speeding stagecoach appear to be moving slowly backwards.

The picture is being sampled by the film camera, but the spokes of the wheels are moving more than one segment of the wheel per sample. This is a case of visual aliasing.

So now we know how to get precise tones out of a waveform table we can concentrate on the tables themselves.

We saw last month that we could put any sequence of bytes in the table and represent various harmonics. However what characterises the sound of a real instrument is the changing harmonic content of the note over time.

If you have experimented with the Envelope command on the computer's built-in synthesiser you will know the tremendous difference this makes to the sound.

However the Envelope command

only varies the amplitude of the note produced by the computer. What we need is to vary both the amplitude and harmonic mix.

Well, it is not on to change the values in the waveform table when it is being read. But what can be done is to switch the waveform table the pointer is accessing. If this changing is done at regular intervals you can have the waveform changing as the note progresses.

Of course these tables have to be precalculated, but after all you do have a computer to do this. Therefore we need a way of specifying the envelope shape of each harmonic, and that is what this month's software offering allows you to do.

The program is shown in Listing I. It allows you to define 32 waveform tables with up to eight harmonics in each. Then you can hear the results of your creation by pressing the keys on the keyboard.

The program is simplicity itself to operate. It uses nearly all the available memory on a disc machine and so, if you have more memory-grabbing sideways ROMs installed, you should set PAGE to &1900 before loading the program.

Alternatively you could apply memory-saving techniques such as removing the spaces and making multi-statement lines.

The only action I had to take was to remove the remarks from the machine code section, but as this is identical to that in Listing II you can follow what is happening.

When it is run the menu will appear after a short initialisation time. The first thing to do is select how many harmonics you want to use - two will be fine to start with.

Then you can select the "draw" option. You will be asked which harmonic you want to view, so type the appropriate number.

You will then get a display of the envelope of the harmonic. The first time around this may be anything, as the description is stored in memory and not initialised each time the program is run. This allows you to debug or make modifications to the program without destroying your work.

The envelope can be defined by use of the cursor keys. You will see at the bottom of the graph two pointers, one of them underlined. This is the active pointer and may be moved to the left and right with the cursor keys.

By using the up and down cursor keys the harmonic value at that point may be altered. The envelope is drawn

THE BEEB BODY BUILDING COURSE

as a straight line between the two pointers and as the active pointer value is moved so the envelope rubber bands.

The other pointer may be made the active one by pressing the space bar.

I find the easiest technique is to draw the envelope in small sections, swapping the active pointer and leap-frogging over other pointers. In this way curves can be simply constructed.

An easy way of clearing an envelope is to position the pointers at both ends and press the down cursor key.

The control on the amplitude at each point moves very slowly with the cursor keys. So to get it into roughly the correct position you can hold the shift key at the same time.

All movement is fully protected and it is impossible to exceed the limits on the graph.

When you have finished defining the harmonic envelope you press Return and select the next one. You do have the option of seeing all the harmonics plotted on the same graph. This is useful for a final check.

When you have finished return to the menu. Now select the Calculate option, and the waveform you have just defined is calculated.

First the scaling factors are calculated and then the tables themselves. These are placed directly into memory again so they will not be lost if you re-run the program.

This is where we really make our friendly computer earn its corn. There are 32 tables, each one containing 256 points. Each point needs one SIN calculation and multiplication per harmonic and, as there can be up to eight of these, this works out at over 65,000 SIN calculations.

This understandably takes some time. For a full eight harmonic waveform it will take just over half an hour. Anyway the computer will give you a very approximate estimation of how long it is going to take.

It is probably prudent not to hold

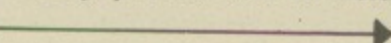

From Page 107

your breath and wait but to go and read the rest of *The Micro User*.

When the computer has finished chugging it will bleep and tell you. At this point you can save the tables on a disc or tape file so that it can be loaded again quickly. Even using tape files it is many times faster than re-calculating it.

The file name you specify is automatically placed in the directory "T", which stands for table, and will help prevent you mixing it up with any programs.

Having safely tucked away the fruits of your labour you can now look at a plot of the waveform tables by selecting the View option. Each waveform is plotted in turn when you press the space bar. Note that if you hold down the space bar the auto repeat function will fill up the buffer and the waveform will be plotted at full speed. Pressing Return will put you back to the menu.

Finally the sound may be heard by choosing the Play option. Each key produces a different note over four octaves. The notes are all in the key of C and are in alphabetic order. Not the easiest way to play a tune – but more of that later.

So you can create a sound and hear the results. I would have liked to include a few more options, but the dreaded "No room" message intervened.

So I wrote a second program (Listing II) which will give a demonstration tune and configure the keyboard in an approximation of a piano keyboard. The row starting with the A key represents the white notes and the keys above it the black ones. Any other key will not produce a note.

As the program can generate notes over four octaves the octave of the keyboard can be shifted by using the space bar. This moves the notes produced by each key up an octave and the octave number is displayed on the screen.

The tables generated by the first program can be loaded by this one. As the section of memory stored on the files

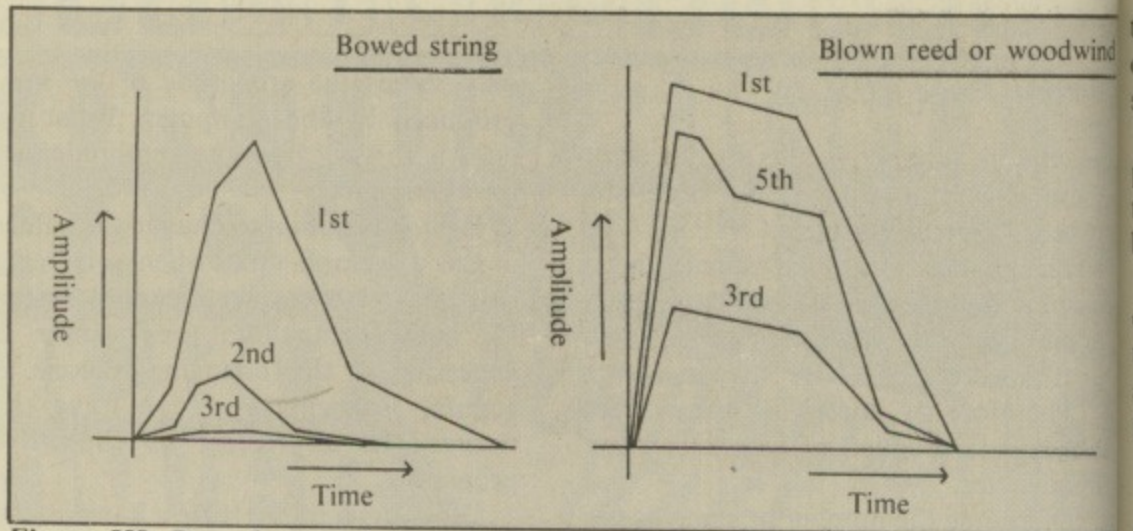

Figure III: Bowed string harmonic envelopes

includes the machine code to produce the note, lines 260 to 820 do not strictly need to be typed.

They are included to prevent the program hanging up if you have not loaded in any tables, and also to let you look at the comments which were removed to make the previous program run in the available space.

Finally the Tune option plays a little jingle. The data included was chosen for its maddening ability to drive you round the bend. The convention used to encode the tune is the same as that used in the musical Christmas card published in the 1983 issue of *The Micro User*, so you can have some Christmas carols if you copy over the data statements.

This program also includes a procedure PROC_SOUND that will accept the same numbers as the computer's sound command, therefore making other single voice tune-playing programs easily adaptable.

The data is plotted out as the tune is playing. This is done to give you something to look at and also allow you to debug the data when creating your own tunes.

You can stop the program at this point by holding down the control and shift keys simultaneously. By rapidly releasing and pressing one of these keys you can get it to play one note at a time.

Note that as the waveform tables are stored in memory you can break and alter this program without having to

reload the tables each time you re-run it.

Finally an explanation of what is happening in the machine code section.

Table I gives a list of the various page zero locations and what they are used for. The two timers in the VIA are used: timer 1 to control the time between samples and timer 2 to determine the time spent on each waveform table.

As there are 32 tables to get through this timer controls the length of the note.

The most significant byte of this timer is stored in memory location &76 and so the length of the note produced can be varied by setting up this memory location before the machine code is called.

When the program is called it first sets up the variables it is going to change through the program. Then the interrupts are disabled, as the processor is going to need all its time keeping up with the program.

The two timers are then initialised and started. Timer 1 is in the continuous mode, whereas timer 2 operates in a one shot mode. The program then goes into a holding loop until timer 1 times out.

Then the pointer is incremented and is used to index the waveform table pointer in locations &72, &73. This uses indirect addressing where the memory location contains not the number but its address. This fetches the next table entry into the accumulator. It is then outputted to the D/A converter.

The program then sees if timer 2 has timed out, and if it has the waveform table to access is changed by simply incrementing the most significant bit of the waveform pointer.

After the waveform table pointer has been changed the required number of times the timers are disabled and the system interrupts enabled and the program returns.

The results can be quite good. On one occasion I even fooled my long suffering wife into thinking someone was playing on our piano.

There is a slight noise caused by the fact that we are only using eight bits and

&70	Fractional part of sample pointer.
&71	Integer part of sample pointer.
&72	LSB of the first byte of the current waveform table.
&73	MSB of the first byte of the current waveform table.
&74	Fractional part of the sample pointer incremental value.
&75	Integer part of the sample pointer increment value.
&76	MSB of timer 2, controls the length of the note.
&78	Number of waveform tables to use.
&79	LSB of the first byte of the first waveform table.
&7A	MSB of the first byte of the first waveform table.

Table I: Page zero memory locations

THE BEEB BODY BUILDING COURSE

that we are only taking the integer part of our sample pointer to access our sample.

Also the changing of waveform tables produces a slight audible noise due to the inevitable phase jump which occurs between one waveform and the next.

Figures III and IV shows some types of harmonic envelopes you may wish to try. These will give you a point to start at. See if you can predict the type of sound you are going to get.

However it is more fun to try to make

up your own instruments and then put a name to them. Two such are shown in Figure V and were named by Hal Chamberlin in the April 1980 issue of Byte. Let's see what you can come up with.

Unfortunately real instruments still have two tricks to play on us before we can get an absolute mimic of their sound quality.

The first is that some instruments, like the piano, change the harmonic mix with different pitched notes. So you

could get a sound like a piano but only over a small range of notes such as an octave.

The second is that certain blown instruments like the flute also have a "breathy" sound mixed in them. This is white noise caused by the act of blowing.

This can be added to the waveforms by adding a small random number to each sample, but I have not got round to trying that yet.

Anyway have fun with creating your own instruments - and get your soldering irons warm for next month's project.

A few hints on typing listings

THE first of the two programs that follow takes a long time to run when calculating the waveforms and it is infuriating to wait over half an hour only to be greeted by an error message.

So to cut down on the running time you can reduce the number of waveform tables you calculate by altering the variable N% in line 50. Remember however that any tables saved to disc can only be read by a program with the same number in N%.

Use the auto numbering command to avoid putting extra spaces at the front of a line, and you would do well to program a function key to re-enable the

editing keys, separate text and graphics cursors and clear the screen.

Keep the computer in Mode 4 or above so as to preserve any waveform tables or harmonic envelope descriptions you have calculated.

Change line 260 from "2 STEP 2" to read "3 STEP 3" in order to get a listing on assembly of the machine code. Remember this can be changed back when you have that section working.

Finally, if you do not feel up to it, remember that both programs are available on tape and disc along with the D/A converter offered last week. The order form is on Page 213.

**Full listing starts
on Page 179**

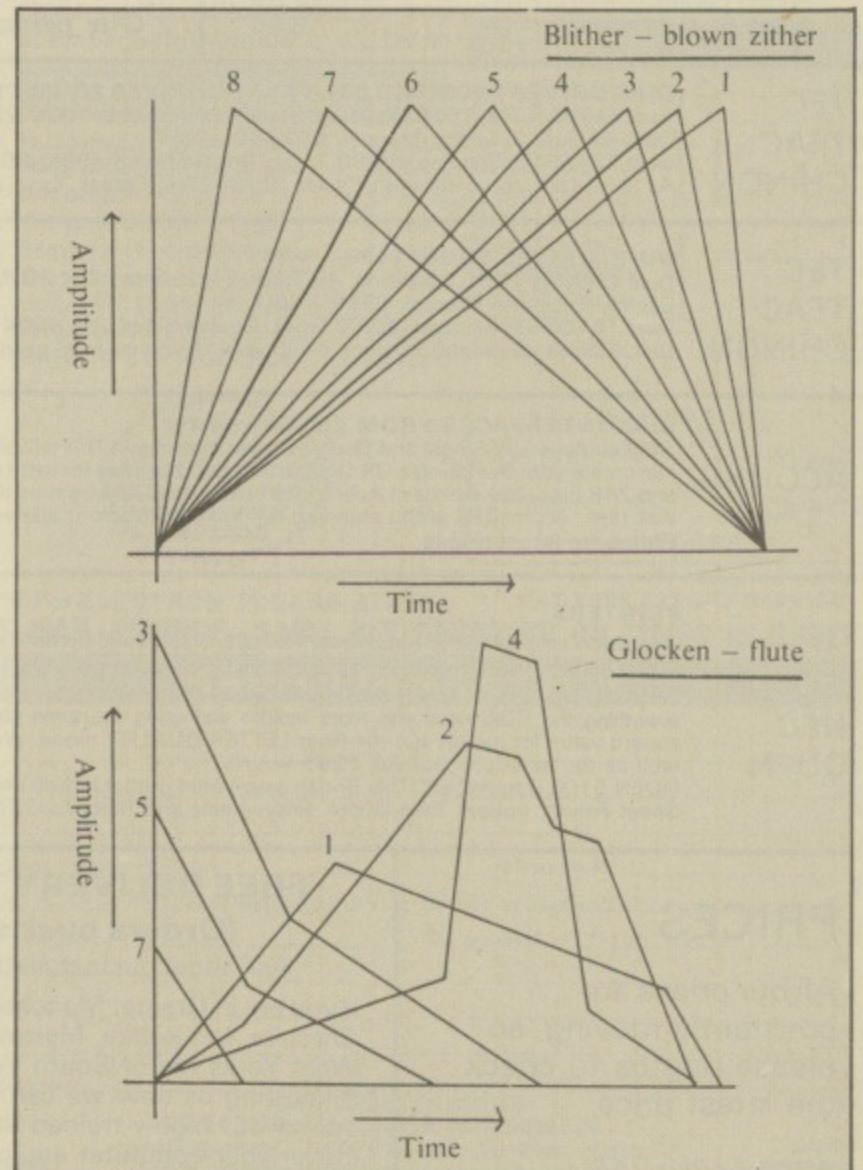
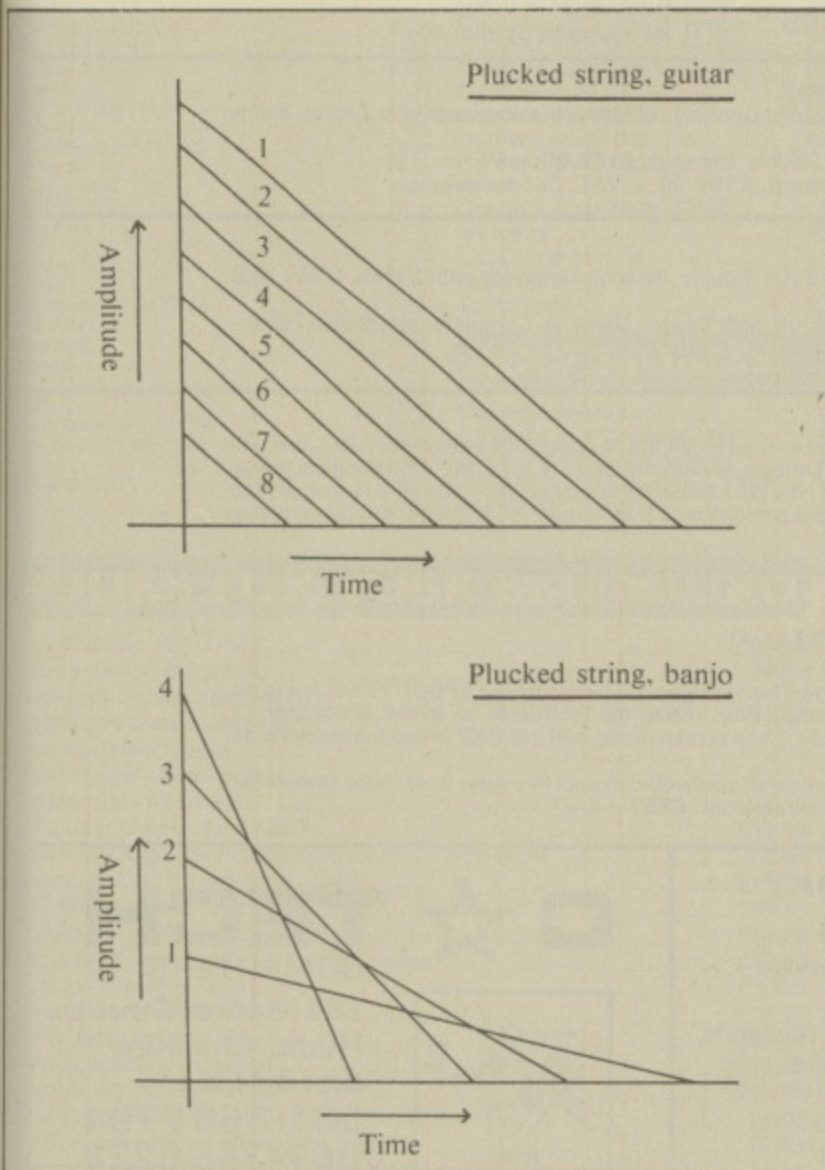
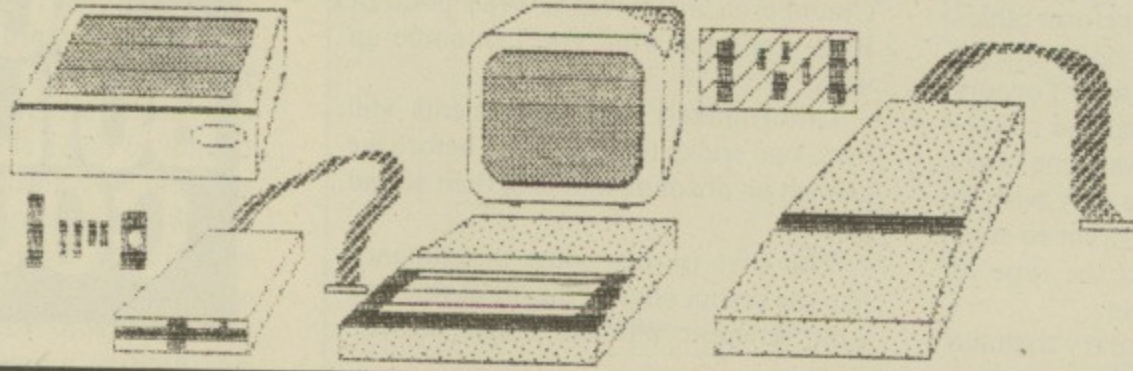

Figure IV: Plucked string, guitar and banjo envelopes

Figure V: Hypothetical instruments' envelopes

BBC Microcomputer in the NORTH

CTECH Computers Telephone: 061-366-8223/7794



Computers	£ p
BBC Model B	346.95
BBC Model B with DFS	407.82
BBC Model B with DFS & Econet	439.00
BBC Model B with DFS & Wordwise	433.92

Acorn Equipment	£ p
6502 2nd Processor	173.04
Z80A 2nd Processor	346.95
Teletext Adaptor	199.00
Electron Computer	173.04
Electron Plus One	51.30

All computers come with Free Cassette Lead and Software Package. Most add-ons include Free Fitting and installation.

Monitors	£ p
Philips Hi Res	68.69
Microvitec Normal Res	199.00
Kaga Normal Res.	179.00
Kaga Medium Res.	285.00
Ferguson TX-90 RGB/TV	199.00

Light Pens and Joysticks	£ p
Add on Light Pen	21.70
JMB Full Analogue Joystick	13.00
Joystick Pairs	17.35
Hi-Fi Extension Cable	5.17
Atari type joystick to BBC interface	

Components and Cables	£ p
We stock everything e.g.:	
2764 Eproms	6.52
27128 Eproms	LOW
8271 Eproms	POA
Printer Cables	12.99
Disk Power Cables	8.65

DISKETTES

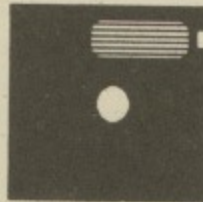

Boxes of 10 diskettes
 BASF s/s d/d diskettes £13.00
 BASF d/s d/d 96 tpi £20.78
 XIDEX diskettes £15.22
 Control Data d/s d/d 96 tpi
 £19.91
 Control Data d/s d/d 96 tpi
 £14.74

MASTERCLASS
 Video Tapes
 Our price £8.65

Addons	£ p
HCR Electronics ROM/RAM board	36.52
HCR Electronics Eprom Programmer	£49.00
Light Pen	21.69
OEL 200 Prestel Terminal	87.39
Acorn Speech Synth	47.83
Chip Chat Speech Synth	26.04
Pace Grapevine	POA
Disks	POA

ROM Software	£ p
Wordwise	34.74
Graphics ROM/Disk Doctor	28.65
Print Master/Termi	28.65
View 2.1	52.09
Ultra-Calc	56.48
1.2 O.S.	10.00
BCPL	86.09
Commstar	30.39
Viewsheet	52.09
Beebugsoft Toolkit	23.48
Beebugsoft Spellcheck	17.35

TEC **DISK DRIVES FROM £95.00 + VAT. TEC DRIVES FROM £109 + VAT.**
 Bare CHINON FO51D, Slimline, 40 Track, Single Sided. 100K (200K Double Density). As above but complete with Cables, Utility Disk, Cables, Case and Manual. **£109.00 + VAT**
TEAC Bare TEAC55F, Slimline, 40/80 Track, Double Sided 400K (800K at Double Density). **£169.00 + VAT**
CHINON As above but complete with Cables, Utility Disk, Cables, Case and Manual. **£199.00 + VAT.** Call for details.

TEC **DUAL DRIVES FROM £199 + VAT**
 Dual CHINON FO51D, Slimline, 40 Track, Single Sided 2 x 100K (2 x 200K Double Density). Complete with Cables, Utility Disk, Cables, Case and Manual. **£369 + VAT**
TEAC Dual TEAC 55F, Slimline, 40/80 Track, Double Sided. 2 x 400K (2 x 800K with Double Density). Complete with Cables, Utility Disk, Cables, Case and Manual. (With your drive you may need an interface). **£389 + VAT.**
CHINON

ACORN **DISK INTERFACES FROM £69.00 + VAT**
 The Fabulous LVL Single and Double Density Interface. This will allow you to read and write to Acorn Disks see below. But also you can create your own Single OR Double Density Diskettes for extra online storage. Maximum capacity is 1.6 MB with 8 logical drives and 248 files. The standard Acorn Interface is available from us this uses the 8271 disk controller which gives very fast access to disk files. Acorn DFS is the standard for the BBC Micro it allows 31 files per disk and a maximum of 800K on 4 logical drives.
Phone for latest prices.

CANON **PRINTERS**
 NEC dot matrix printer bi-directional 120 cps. Tractor and friction feed **£199 + VAT**
 QUEN data dotmatrix printer British assembled (Epson compatible) **£173.04 + VAT**
NEC CANON PW 1080A. This is the latest state of the art in printer technology. This machine out performs the EPSON FX80. It will do everything the FX80 does and more besides and using the same control codes! What makes the PW1080A so special is not only it's superb value for money but the Near LETTER QUALITY mode. We include a free screen dump and our BBC Micro Instructions as well as the excellent manual. **£259 + VAT.**
QUEN QUEN 5100 Daisywheel. This British assembled printer has all the features that you would expect like Auto Bold, Auto Underline, Sheet Feeder option. Take Qume daisywheels and Ribbons. 20Cps Bi Directional. **£299 + VAT**

PRICES ...
 All our prices are constantly moving, so please ring us to check the latest price.
All prices Plus VAT

FREE DELIVERY TODAY
(Orders over £90)
 Ask about our installation service
 If you are in Greater Manchester, Cheshire, Lancashire, Merseyside, Midlands, West Yorkshire or South Yorkshire, if you ring us now we can send one of our highly trained staff to install your computer equipment Today. (Now for Business software too!)



C ★ TECH
COMPUTERS
184 Market Street,
Hyde, Cheshire
SK14 1EX
061-366 7794
061-366 8223



p&h electronics Ltd

5 THE PARADE, YATELEY 22/24 GUILDFORD ROAD
NEAR CAMBERLEY, SURREY BAGSHOT, SURREY
Tel: Yateley 0252 877222 Tel: Bagshot 0276 73078



MICRO CENTRES

TELEPHONE OR VISIT ALL PRICES INCLUDE VAT

ACORNSOFT

EDUCATION	
Algebraic Manipulation	£9.95
Penko Computer	£9.95
Business Games	£9.95
Tree of Knowledge (*£9.20)	£9.95
Word Hunt	£11.90
Word Sequencing	£11.90
Sentence Sequencing	£11.90
Number Balance	£11.90
Missing Signs	£11.90
Chemical Analysis	£13.80
Chemical Simulations	£13.80
Chemical Structures	£13.80
Jigs	£11.90
Temperature Control	£9.95
The Examiner	£9.95
LANGUAGES	
Forth (*£16.10)	£16.85
Lisp (*£16.10)	£16.85
Microtext	£49.85
Turtle	£16.85
S-Pascal	£16.85
GRAPHICS AND OTHER	
Creative Graphics (*£9.20)	£9.95
Graphs + Charts (*£9.20)	£9.95
Picture Maker	£9.95
Shirley Conran's Magic Garden	£9.95
Collector's Catalogue	£9.95
Membership Manager	£9.95
Linkword - French	*£14.95
Linkword - Italian	*£14.95
Linkword - Spanish	*£14.95
Linkword - German	*£14.95
BUSINESS	
Desk Diary	£9.95
Forecast	£11.90
View Printer Drivers	£9.95
Personal Money Management (*£11.50)	£11.90
Database	£11.90
GAMES	
Philosophers Quest	£9.95
Aviator (Disk £17.85)	£14.95
Monsters (*£9.20)	£9.95
Snapper	£9.95
Rocket Raid (Disk £11.50)	£9.95
Arcade Action	£11.90
Sphinx Adventure (*£9.20)	£9.95
Cube Master	£9.95
ICB Digger (Disk £11.50)	£9.95
Chess (*£9.20)	£9.95
Sliding Block	£9.95
Meteors (Disk £11.50) (*£9.20)	£9.95
Arcadians (*£9.20)	£9.95
Planetoid	£9.95
Super Invaders (Disk £11.50)	£9.95
Castle of Riddles	£9.95
Missile Base	£9.95
Countdown to Doom	£9.95
Dragnths and Reversi (*£9.20)	£9.95
Snooker (Disk £11.50)	£9.95
Starship Command (*£9.20)	£9.95
Hopper (Disk £11.50) (*£9.20)	£9.95
Carousel	£9.95
Kingdom of Hamil	£9.95
Drazy Tracer	£9.95

Drogna	£9.95
Free Fall (*£9.20)	£9.95
Meteor Mission	£9.95
Gateway to Karos	£9.95
Tetrapod	£9.95
ACORN/MIRLE BUSINESS SOFTWARE	
(Disk - 40 Track)	
Invoicing	£24.95
Mailing System	£24.95
Accounts Receivable	£24.95
Stock Control	£24.95
Order Processing	£24.95
Accounts Payable	£24.95
Purchasing	£24.95

BBC/ELECTRON

Acorn Electron + Cover	£199.00
Electron Exp1	£59.00
BBC Model A + Cover	£299.00
BBC Model B Start Pack	£399.00
BBC Model B + Disc/Int	£469.00
BBC Disc Interface	£95.00
Speech Interface	£54.00
BBC Teletext Receiver	£220.00
6502 Second Processor	£199.00
Bit Stick	£390.00
Z80 Second Processor	POA

DISC DRIVES

Acorn/LVL 100K expands to double	£199.00
Acorn/LVL dual 100K	£350.00
Pace slim 100K	£160.00
Cumana 100K no P. supply	£165.00
Cumana 200K no P. supply	£180.00
Cumana 400K no P. supply	£240.00
Cumana 100K with P. supply	£190.00
Cumana 200K with P. supply	£220.00
Cumana 400K with P. supply	£250.00
Cumana dual 100K	£350.00
Cumana dual 200K	£370.00
Cumana dual 400K	£480.00
Cumana dual 200K 40/80 switched	£450.00
Cumana dual 400K 40/80 switched	£550.00
LVLDD disc int kit	£115.00
Acorn DFS kit	P.O.A.
Torch pack	£799.00

ACCESSORIES

Cassette Recorder	£24.00
Cassette with Counter + Din	£29.00
Joysticks SW Self-Cen PR	£17.50
J/S Analogue Self-Cen (LVL) PR	£20.00
Crackshot Joystick	£10.95

Micro Dust Cover	£5.00
R.H. ELE Light Pen	£44.00
TV Aerial/Computer Switch	£2.50
Plinth for Monitor	£18.50
ROM Exp Board - 4 Slot	£20.00
Viglen Sideways System	£19.95
Computer Desk + Mains Dist.	£55.00
BBKEY. Function Key Mask	£1.50
Flow Chart Template	£1.50
Datapen with software	£25.00
Computer Desk double width	£55.00
Mains distribution block with plugs	£7.50
LVL Modem	£225.00
Sideways ROM Board	£45.00
Torch Z80 Card	£340.00
Disc Storage Box (35)	£16.00
Disc Storage Box (85)	£20.00
Printer Dust Covers	£5.00
Eprommer APTL	£138.00
Power Cleaner Plug	£13.00

PRINTERS

Epson RX80T	£240.00
Epson RX80FT	£280.00
Epson FX80	£370.00
Epson FX100	£560.00
Epson P40	95.00
Silver Reed EX500 Daisy Wheel	£340.00
Silver Reed EX43 Typewriter + Interface	£399.00
Nec PC 8023	£225.00
Cannon PW 1080A	£330.00
Tally MT80	£215.00
2000 sheets 9 1/2 in Fanfold Paper	£14.00
Epson Serial (2K) Interface	£25.00

MONITORS CTV

Microvitec 14" colour	£220.00
Microvitec 14" Medium Res	£320.00
Microvitec 14" High Res	£460.00
Sanyo 14" colour	£240.00
Sanyo 12" Green High Res	£120.00
Sanyo 12" green	£90.00
Sony 14" CTV with RF input	£229.00
Ferguson 14" CTV + RGB MC01	£240.00
SABA 14" CTV REM + RGB	£245.00

UTILITIES/SOFTWARE

View Wordprocessor ROM	£55.00
View Sheet ROM	55.00
Wordwise	
Wordprocessor ROM	£40.00
Disc Doctor ROM	£29.00
Graphics ROM	£29.00
Bee Bug Tool Kit ROM	£27.00
Bee Bug Exmon ROM	£27.00
Bee Bug Masterfile DISC	£19.00
Clares Replica II DISC	£12.00
Clares B. Base DISC	£23.00
BBC Ultracalc ROM	£70.00
BBC Tool Box ROM	£21.00
BBC Beyond Basic CASS	£11.00
BBC Typing Tutor CASS	£15.00
BBC Record Keeper CASS	£13.50
BBC Home Finance CASS	£9.50
Gemini Database 24K ROM	£129.95
BCPL ROM + DISC + Manual	£95.00
Logo ROM (LCSI)	£65.00
ADE ROM	£60.00

BBC SOFTWARE

White Knight Chess	£11.50
Dr Who	£9.95
Home Finance	£9.95
Early Learning	£9.95
Music	£9.95
Computer Program 1	£9.95
Computer Program 2	£9.95
Painting	£9.95
Drawing	£9.95
Canyon	£9.95
Tax Calc	£17.00

GEMINI

Cash Book Acc.	£95.00
Beeb Calc	£19.95
Inv. & Statements	Add £19.95
Commercial Acc.	£4.00 £19.95
Mailing List	for £19.95
Database	disk £19.95
Stock Control	version £19.95
Home Accounts	£19.95
Word Processor	£19.95
Liberator	£9.95
Missile Control	£9.95

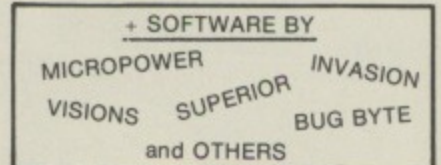

BOOKS FOR YOUR BBC MICRO

30 Hour Basic - BBC/NEC	£6.95
Beyond Basic - BBC/NEC	£7.25
Creative Graphics - Acornsoft	£7.50
Graphs and Charts - Acornsoft	£7.50
Advanced User Guide	£12.95
Forth Manual - Acornsoft	£7.50
Lisp Manual - Acornsoft	£7.50
BCPL User Guide - Acornsoft	£15.00
Assembly Language Programming for BBC - Birnbaum	£8.95
Advanced 6502 Programming - Zaks	£10.25
6502 Applications - Zaks	£9.75
6502 Assy. Language Sub Routines - Leventhal	£14.25
6502 Assy. Language Programming - Leventhal	£12.95
Basic for Business - Hergert	£10.95
Starting Forth - Brodie	£15.25
Introduction to Forth - Knecht	£9.30
Z80 Applications - Coffron	£11.95
Programing the Z80 - Zaks	£13.95
Basic Programming for the Electron - Cryer	£6.95
Electron Assembly Language - Smith	£7.95
Electron Programming for Education - Hall	£5.95
Graphic Art for the Electron - Allan	£5.95
The Electron Book - McGregor	£7.95

*E For ELECTRON PLEASE STATE VAT FREE EXPORT SERVICE FAST MAIL SERVICE - SAME DAY DESPATCH ON ITEMS IN STOCK

MAIL ORDER COUPON

Please send me:

1 _____ 4 _____

2 _____ 5 _____

3 _____ 6 _____

I enclose cheque /P.O. for _____ P&P see below

Or please debit my Access/Barclaycard/Visa* (delete as applicable)

Card Number _____ Expiry date _____

Name _____

Address _____

Telephone _____

P&H ELECTRONICS LIMITED
22/24 Guildford Road, Bagshot, Surrey GU19 5JN
CARRIAGE COSTS - Micro's, Monitors, Disc Drives, Printers £7
Books, Cassette Decks, Leads, Software 50p each item.
ACCESS, BARCLAYCARD VISA ORDERS WELCOME
CREDIT FACILITIES Instant credit up to £1,000. deposit 10%

See our programs on MICRONET 800

PERSONAL
COMPUTER
SOFTWARE

Proxima

Beeb-Text features:
Width
Height
Italic

**BIG
Print**

(c) Proxima Software
Very wide and
Very tall text as well as normally sized text

THINK BIG *
A highly effective machine-code program for displaying any dimension text. Can be incorporated into other programs.

Cassette £5.95
Disc £8.95

PIXEL PACKAGE *

Two programs are supplied for designing single colour and multi-colour characters and designs can be mirrored, inverted, rotated and duplicated. The programs even store the resulting data in program lines ready to be used.

Cassette £7.95
Disc £10.95



TWO PLAYER GAME *
Two 2-player games including 4Line and Frustration, joystick compatible.

Cassette £6.95
Disc £9.95

"Star" denotes Electron compatible

BEEB-TEXT

A sophisticated and unique machine-code program which allows virtually unlimited variation in the BBC's text display. The user has the option of varying character thickness, italic, styles, height, width, colour combinations, etc. Up to 8 different fonts can be displayed in one page including shadowed and outlined types. Beeb-Text displays text in proportional spacing too however the user can also control, character and line spacing independently.

Disc £15.00

FONTS
ONE FIVE
THREE SIX
FOUR SEVEN
EIGHT

Spacing
Spacing
Spacing
Thickness

▲Prices are fully inclusive, no extra to pay.
▲P&P on all orders is FREE!
▲Please make cheques/P.O.'s payable to PROXIMA SOFTWARE.



DISC TOOLS The complete utility disc for twin 80 track drive users and includes a 40/80 or 40/40 or 80/40 backing up facility.
Disc £10.95

ROBOBRAIN Arcade fun. Disable the robot's positioning brain but watch out for its self defence.
Cassette £7.95
Disc £10.95

PROXIMA PERSONAL COMPUTER SOFTWARE,
Newlands, 30 Sparelease Hill, Loughton, Essex, IG10 1BT.
Tel. 01-502-0230
Our FREE program special offer continues. Contact us for details!

Copter Capers



STACK LIGHTPEN 100

ATARI...VIC-20...CBM 64
A beautifully styled, high
quality colour light pen for the
BBC, with touch controls.

NEW RELEASE
BBC

Easy to use...simply hold the LIGHT PEN against the T.V. screen, place a finger on the 'Touch Contact' and the pen is working. You can produce programs in which the LIGHT PEN places data (alphanumeric or graphical) onto the screen, removes data from the screen

or triggers off a series of events or instructions. Complete with user manual and a free game on cassette (worth £5.75) to get your software library started.

ONLY **£28.75** incl. VAT
FREE POSTAGE!!

Stack Products are available from selected branches of: GREENS DEBENHAMS, DIXONS, JOHN MENZIES, SPECTRUM, W.H. SMITHS

HOW TO ORDER

Most computer dealers either stock or can obtain **STACK 100** products for you, or you may order direct from us. Packaging and postage is FREE within the U.K., overseas customers please add airmail postage.

Payment may be made by sending a cheque, postal order or by credit card, 24hr answerphone service.

Please send me full details of your BBC products.

Name _____

Address _____

GRAPHIX-ED

An excellent colour graphics program for your BBC. Easy to use, but be warned, any slight interest in graphics can quickly become an addiction!

- use normal, medium or hi-res graphics
- choose 1, 4 or 16 colours

- controlled by single letter commands
- optional grid display to aid accuracy
- duplicate pictures on other parts of the screen
- picture buffer
- save and recall pictures from cassette
- comprehensive user manual
- quick reference guide to commands

THE COMPLETE PACKAGE COSTS **£9.00** incl. VAT

BBC JOYSTICK

Full joystick control — in any direction — and it fires too!!

ONLY **£13.80** incl. VAT

STACK 100

FREEPOST
BOOTLE, MERSEYSIDE L20 0AB

051 933 5511

24hr answerphone

The Life Savers!

Save Your Buddies - Play Copter Capers!

Another mindbender from A'n'F—Copter Capers. A new game that's got plenty of capers instore for you! You've got to rescue your buddies from the Pacific Ocean but you'll have a few problems like enemy copters, submarines and balloons— **£6.90** all trying to stop you.

ANOTHER RIVETING GAME FROM A 'n' F SOFTWARE

BBC 32K—Other games available:
Chuckie Egg-£7.90, Cylon Attack-£7.90,
Haunted Abbey-£6.90, Snarl-Up-£7.90.

Interested?



A&F Software, Unit 8,
Canal Side Industrial Estate,
Woodbine Street East, Rochdale OL16 5LB
Telephone: Rochdale 341111

Whether your needs are for Serious, Business, Educational (Leisure) BBC/ Electron Micro, you can be sure that Gemini offer THE BEST

GEMINI
Serious Software

BBC MICRO

DATA

JEM

The most advanced software ever written for the BBC Micro? Or just the most advanced and comprehensive Database Management System? Read this check list of main features, and decide for yourself!

0901
£129.95

- 24K ROM Based Random Access Database with 184 page manual.
- Allows searches on any field or COMBINATION of fields to ANY depth.
- Up to 9 subsets of data INSTANTLY available and saved to disk automatically.
- Sorts alphabetical or Numeric on any field, ascending or descending with NO LIMIT on the depth of sort.
- Interfaces with 'VIEW' and 'WORDWISE'.
- Includes a free format report generator for a completely flexible printing format.
- Allows the user to extend the file or add fields after having started to enter data.
- Allows up to 5100 User Definable Records with up to 62 fields per record and a maximum file size of 10 Megabytes.
- Permits just ONE file to exist over FOUR floppy disk drive surfaces.
- Offers a free format painted screen which scrolls 120x120, and supports extensive mathematics.
- Provides User defined field relational variables and multiple and single character wildcards.

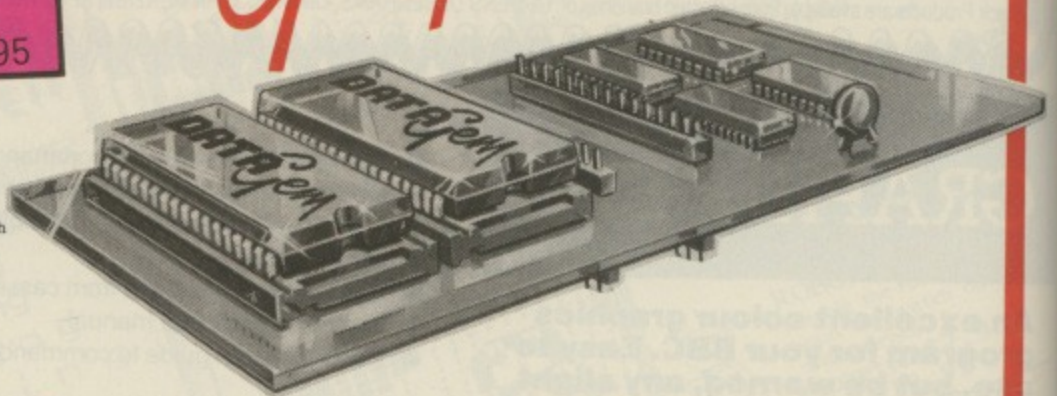

- Exists self contained on ROM, and does not require additional utilities on disk.
- Finds the occurrence of a string or partial string in ANY field in the database with just one command.
- Customised Masking disk design service available for commercial and professional users.

INTEGRATED ACCOUNTING

for the BBC Micro.

Designed for the small to medium sized business user, where speed and efficiency are vital. Gemini Integrated programs are suitable for sole traders, partnerships or limited companies. All require a BBC B 32K microcomputer, and an 80 column printer. A double disk drive with an Acorn compatible DFS is required for integrated accounting purposes. A single disk drive may be sufficient where modules are used independently, although this is not recommended for the Sales Ledger and Invoicing module. The manuals indicate the system capabilities for various disk drive combinations.

£99.95
per module

PRE-PRINTED...

Continuous Invoices, Statements, Remittance Advices and Payslips available.

Demo Disk £5.00 refundable on the purchase of any module.

Why Integrated Accounting?

Because it will retrieve information stored in one program for use by another and store data in one program which has been generated by another.

Why Gemini?

Because our business software for the BBC Micro is based upon the solid foundation of experience. Not only are three of our Directors Chartered Accountants, but we have also successfully written business software for the BBC Micro since it was first launched.

INVOICING & SALES LEDGER

Produces Invoices and Statements holds complete customer information - 135 on 40 track 610 on 80 Track.

STOCK CONTROL
Full stock information for 980 part nos. on 40 Track or 1980 per 80 Track disk.

NO SECOND PROCESSOR REQUIRED

PURCHASE LEDGER

Maintains complete file for each supplier - 135 on 40 Track or 610 on 80 Track disk.

NOMINAL LEDGER

The central module which can also be used as a 'stand alone' Cash Book. Contains 143 Nominal Accounts, prints Profit & Loss Accounts and Balance Sheet.

PAYROLL

Holds full employee information produces payslips for 98 employees (40 Track) 198 (80 Track.)

NEW IMPROVED DATABASE

C.0101 Cassette 19.95
D.0101 Disk 23.95

This new memory based database for the BBC Micro uses machine code to optimise the memory available and improve processing speed, and includes the following features:

Records are presented as a completely user-definable card on the screen, with up to 15 fields of data. Main routines provide the facility to add, modify or delete records, to sort the entire file by any record, and comprehensive searches may be performed using combinations of any fields. Results of searches may be screened or printed as a summary of up to six fields, or as complete records. Calculations allow field contents to be derived from a number of other fields, which may be used for example, to give total, average, etc.

Strongly recommended as an invaluable program for home, business or educational requirements.

GEMINI
Leisure Software

MISSILE CONTROL

C.0150 BBC Micro
C.1650 Electron **£9.95**

The best game ever written or simply the best game yet written for the BBC/Electron?

Quote **ABC Computing - October 84** - Rating: Sounds 100% Graphics 90% Documentation 90% Overall 95% "An exceptional game - brilliantly done - pity all those families down the street having a quiet evening in".

Quote **Acorn User - January 84** "A must for Arcade Action freaks!"

What **Micro Nov 83**: Graphics 10/10 Response 10/10 How enjoyable 10/10 Addictiveness 10/10 Value 10/10

Other titles for the BBC Micro include: Liberator, Sleigh Bells, Caterpillar and Traditional Games.

all leisure software for your
BEST programs available.



Educational Software

£7.95 per program
 (cassette only)

Written and designed especially for use by pupils, parents and teachers, Gemini's brilliant new educational software has been produced in consultation with School staff, and has benefited from the several years teaching experience of DAVID J. GINGELL

MA (Oxon) Cert Ed (Bristol University), Director of Educational Software, Gemini Marketing Ltd.

It uses the power of the BBC and Electron Micros, with their high resolution colour graphics, to appeal

AGES 5-7

EDWARD BEAR Tells the Time
 C.0176 BBC MICRO
 C.1675 Electron
 The ideal way to teach any child to tell the time... beautifully produced with brilliant graphics.

AGES 6-11

OLIVER OWL
 C.0172 BBC Micro
 Jumps for joy or falls off his branch as multiplication tables are quickly and enjoyably mastered.

AGES 3-5

COUNTING FUN
 C.0170 BBC Micro
 C.1670 Electron
 Teaches basic number recognition to the very young as a foundation for subsequent arithmetic programs, and uses easily recognised animated characters such as clowns and Penguins. An ideal introduction to basic counting principles.

AGES 5-8

PIRATE PEDRO
 C.0171 BBC Micro
 C.1671 Electron
 Teaches fundamental addition and subtraction, with Pedro finding his treasure, provided a score of 7/10 is achieved. Holding 9 levels of difficulty, this is the ideal follow-up to 'Counting Fun'.

AGES 3-7

ALPHABET FUN
 C.0174 BBC Micro
 C.1674 Electron
 An imaginative program to teach your child character recognition and easy spelling, before moving on to 'Word Quest'.

AGES 6-11

WORD QUEST
 C.0175 BBC Micro
 An imaginative, amusing version of "Hang Man" in which you can try to beat the computer's dictionary, or set up your own files.

AGES 7-11

FELICITY FARMGIRL
 C.0173 BBC Micro
 C.1673 Electron
 Teaches simple division by sharing food to the farm animals. Deals with the difficult subject of teaching 'remainders' in a novel and appealing way.

to pupils with original and often amusing screen displays, which attract and hold their attention, and rapidly enhance both knowledge and proficiency.

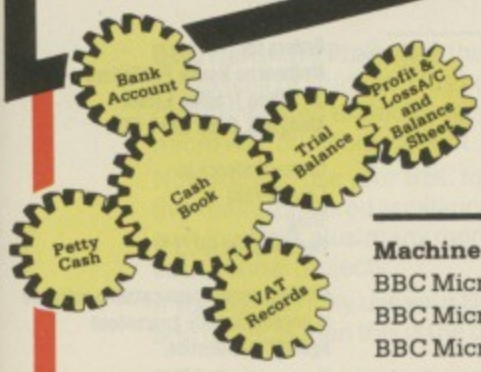

COMPLETE CASHBOOK ACCOUNTING SYSTEM for the BBC MICRO Price £119.90 (cassette/40Tr/80Tr Disk)

The best in the business! Written by businessmen, for businessmen, Gemini's accounting software brilliantly maximises the potential of the home Micro for commercial use. Containing a professional standard manual, this System is ideal for CASH BASED businesses, where credit sales are minimal. It allows the user to transfer all Cash, Petty Cash and VAT transactions onto the Computer, saving hours of tedious book-keeping, and allowing more profitable use of valuable time.

Most important of all, it produces Profit & Loss Accounts and Balance Sheets, DIRECT from your original book-keeping entries, together with notes to the accounts and comparative figures. Ideal for practising Chartered Accountants OR Business owners who wish to operate a more effective, efficient and profitable accounting System.

Machine	Product Code
BBC Micro - Cassette	C.0405/6
BBC Micro - 40 Track disk	D.0405/6/40
BBC Micro - 80 Track disk	D.0405/6/80

Available from:
 Larger branches of Boots and W.H. Smith and most good software dealers... or phone Gemini for prompt despatch quoting your Access, Visa, or American Express card number. Telephone (0395) 265165. Alternatively make your cheque or Postal Order payable to Gemini Marketing Ltd., and send to Gemini Marketing Ltd., 18a Littleham Road, Exmouth, Devon EX8 2QG.

Please send urgently (specify 40 or 80 track)

Prices stated in this brochure include VAT and Post and Packing (UK only).

Name

Address

Signature

Credit Card No. Access/Visa/American Express (delete)

Please send further information concerning: **MU**

Other Superb Gemini Software for the BBC Micro includes:

Spreadsheet Analysis, Word Processor, Home Accounts, Graph Plot and Mailist. All on Cassette at £19.95, 40 Track Disk £23.95 or 80 Track Disk £24.95. Also available on cassette only for the Electron £19.95.



HATS OFF TO MELBOURNE



BBC BOOKS & SOFTWARE

Books

- BBC Hardware Projects £9.95
- BBC Software Projects £6.95
- Building Blocks for BBC Games £5.95
- Guide to BBC ROMs £9.95
- BBC BASIC for Beginners £7.95
- Complete BBC BASIC Course £9.95

Software

- BBC/Electron Classic Adventure £6.95
- BBC The Hobbit, Model B £14.95

GENERAL BOOKS

- A Guide to Playing The Hobbit £3.95
- Computer and Video Games Book of Adventure £5.95
- Learning With Adventure Programs £5.95
- Z80 Reference Guide £9.95
- 6502 Reference Guide £9.95

Orders to:
Melbourne House Publishers
39 Milton Trading Estate
Abingdon, Oxon OX14 4TD

Correspondence to:
Church Yard
Tring
Hertfordshire HP23 5LU

All Melbourne House cassette software is unconditionally guaranteed against malfunction.

Trade enquiries welcome.
Due to memory limitations, BBC cassette version does not include graphics.

£
£ + p/p .80

Total

£

All prices include VAT where applicable.
Please add 80p for post and pack.

Access orders can be
telephoned through on our
24-hour ansafone (0235) 83 5001.

I enclose my cheque/money order for £

Please debit my Access Card No.

Expiry Date

Signature

Name

Address

Postcode

MU11



MELBOURNE HOUSE!



BBC Hardware Projects is the A.B.C. of BBC interfacing for the enthusiast or student. This book will enable you to add a whole new dimension to electronic projects by interfacing your BBC micro with other equipment.

Now you can use your BBC to operate up to two hundred and fifty five mains powered appliances and domestic lighting, build your own joysticks plus many more practical, experimental and educational projects.

If you want to fully use your BBC in your own electronic hobbies and projects then this is the definitive book for you.

BBC Software Projects is a special book which will enable you to create useful programs and learn more about programming.

Software Projects gives you program ideas, discusses the overall set-up and an outline of the various procedures. You write the programs, and Software Projects tells you how to test it or offers hints and clues on how to do it. Create six useful programs, ranging from information management, business programs and games.

Building Blocks For BBC Games is the book for all BBC and Electron enthusiasts! Using a unique modular method you can create and build exciting, original games and programs.

The ready-made building block system has all the procedures you need. Step-by-step you write a BASIC program with the minimum of effort. Then you can expand your programs with even more procedures and innovations into complex and exciting routines.

Simply written, easy to follow, with BBC Building Blocks you will learn more about your micro than you believed possible.

Classic Adventure was the first major computer game and now it's become a classic in its own time. This exciting release of Classic Adventure for the BBC/Electron will enable you to slay dragons, find hidden treasures and bribe trolls.

"Great fun for any adventurer whether a beginner or experienced."
- Games Computing

"It's excellent but be warned: it's also very addictive." - Home Computing Weekly

"Classic brainteaser" - Micro Adventurer

"Your collection will not be complete without it." - Adventure Helpline

The Hobbit. Visit JRR Tolkien's Middle Earth in the most amazing adventure yet devised.

"One of the best adventures." - Personal Computer Games

"The Hobbit will give adventure fans many hours of brain-racking fun." - Home Computing Weekly

"The Hobbit is in a class of its own for interaction."
- Practical Computing

The Hobbit is a pleasure to play and, even after successfully completing the treasure-hunt, there are still challenges." - Popular Computing Weekly

"A superb adventure." - Popular Computing Weekly

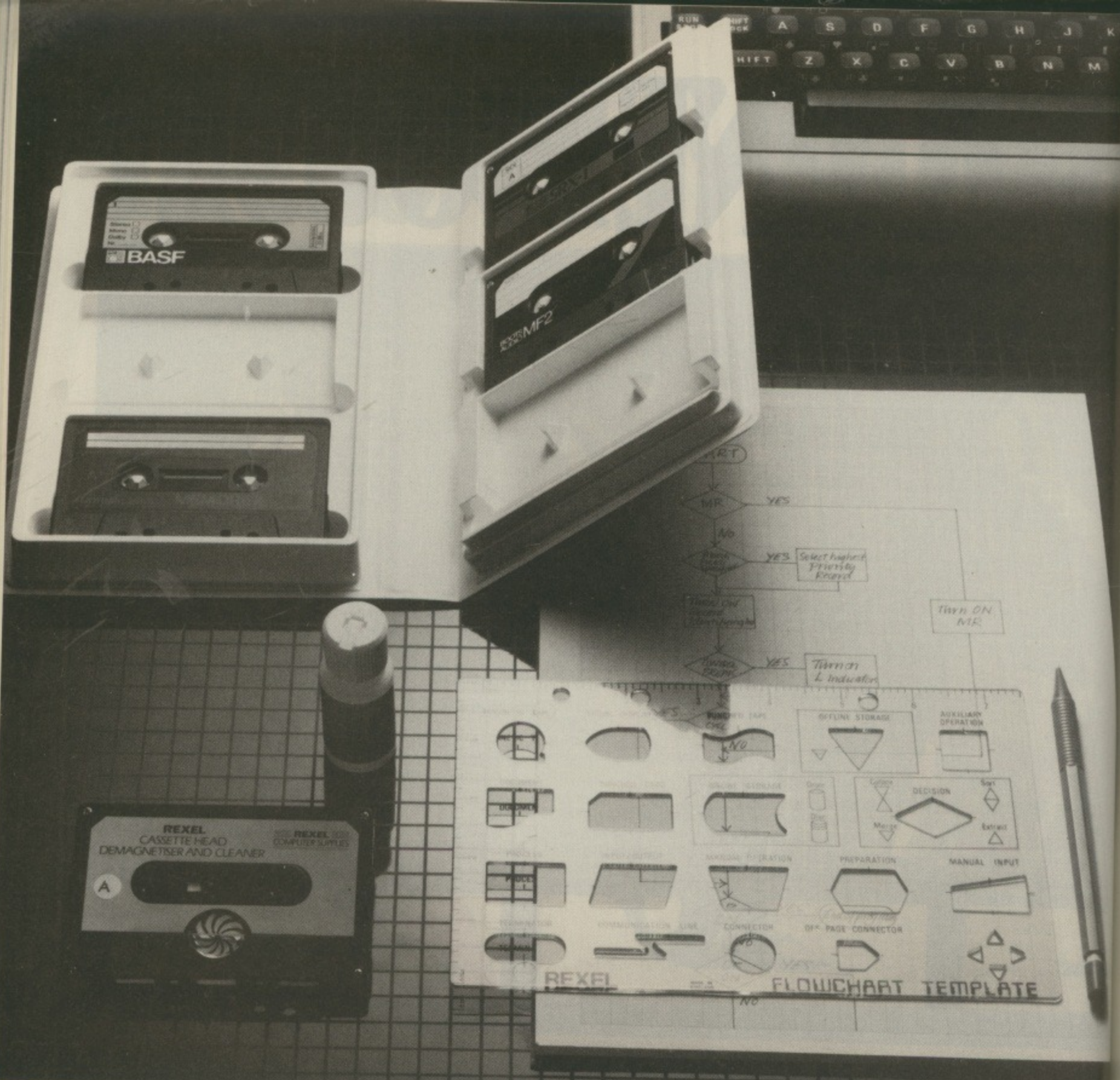

£11.49 OR LESS. HOW'S THAT FOR STARTERS?

Everything you need to organise yourself and to operate and maintain your computer – cassette storage, programming, cleaning – all together in one complete kit.

The Rexel Home Computer Starter Kit is put together by experts to help you get the very best out of your micro, especially if you are starting on the exciting business of creating your own programs.

Compatible with every cassette driven micro, it is available now at W.H.Smith, John Menzies and other leading suppliers. And at £11.49 or less, it's an absolute gift.

Also look out for the range of Rexel Computer Care and Maintenance products. Prices start from £3.50. You couldn't have a better start than that.

For more information on the Rexel Computer Care products, write to:
 Rexel Ltd, Gatehouse Road, Aylesbury, Bucks. HP19 3DT

Cassette binder supplied without cassettes

REXEL
 COMPUTER SUPPLIES

TAKE A CLOSER LOOK AT REXEL



- CONTENTS:**
- 1 Programmer's Pad
 - 1 Data Cassette
 - 1 Fine-Mesh 'Sponge' Demagnetiser & Cleaner
 - 1 Fine-Lined Outdoor Cassette Clearing Solution
 - 1 Taping Method
 - 1 Cassette Binder

SY
 AL
 IBM
 2
 Pe
 Pe
 plu
 (m
 SA
 80
 2 x
 Ma
 (M
 EL
 Inc
 BE
 Inc
 Sof
 PR
 Bro
 Juk
 EP
 EP
 Incl
 O
 P
 SE
 TO
 AL
 MA

SYSTEMS

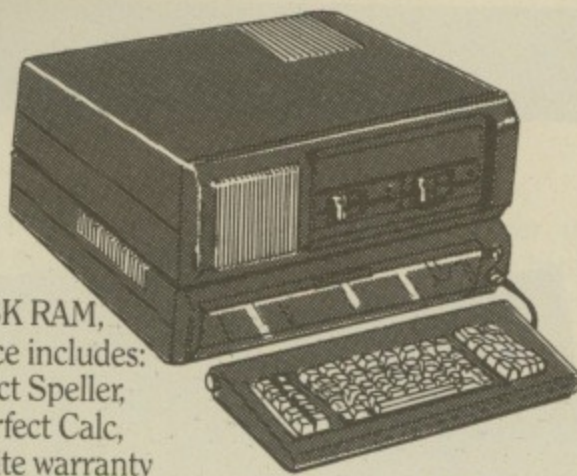

ADVANCE 86

IBM compatible, 128K RAM, 2 x 320K Drives. Price includes: Perfect Writer, Perfect Speller, Perfect Filer and Perfect Calc, plus 12 months on site warranty (monitor available at extra cost).

£1349

SANYO 555 Q

80% IBM compatible, 128K RAM, 2 x 360K Drives. Price includes: Wordstar, Mailmerge, Info-Star and Calc-Star.



(Monitor available at extra cost) **£1148**

ELECTRON £199

Includes free software tape

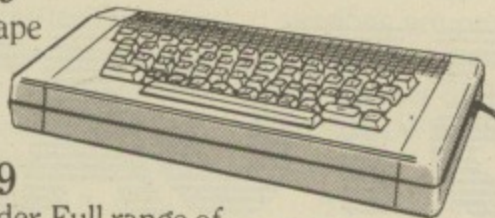

BBC-B £399

Includes free tape recorder. Full range of Software and Disk Drives available.

PRINTERS

Brother Printer HR 15 **£399**
Juki Daisywheel 6100 **£389**

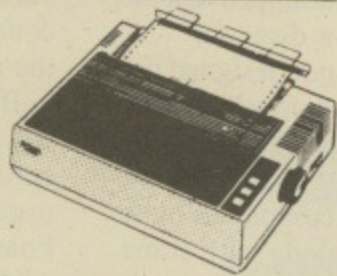

EPSON RX80 FT **£269**
EPSON FX80 **£379**

Including lead for BBC.



DISKETTES

Control Data, in packs of 10
SS 40tk.....£18.00
DS 40tk.....£23.00
SS 80tk.....£26.00
DS 80tk.....£29.00

Including VAT, p&p.

End of season means discounts at Microware



EPSON DISK DRIVES

200K-400K-800K plus new 3 1/2" range (including manual 8 formatter)

100k single unit **£139**
100k dual unit **£229**
200k single unit **£195**
200k dual unit **£325**

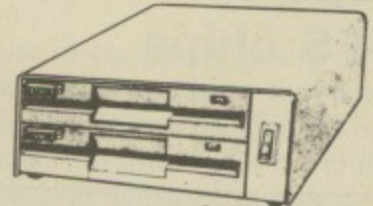

400k single unit **£225**
400k dual unit **£349**
Switchable **£375**

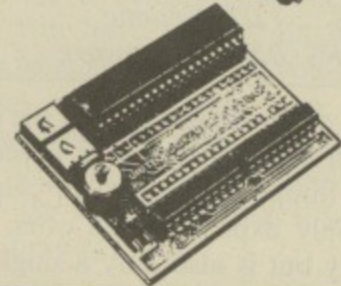

UDM DDFS £95

MONITORS

Microvitec colour
Normal res. **£199** LS = +£25
Medium res. **£299**
High res. **£399** AP = +£25
Sanyo/BMC 12" C **£110**

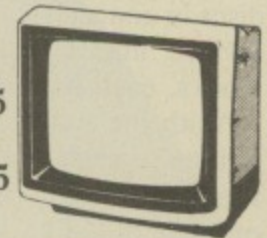

Call for our full price list.

Special Offer

27128

(250 ns) only

£17.50 +VAT

ACCESSORIES

BBC Stands.....£15.00
Dust covers.....£5.60
(for BBC, Drives and Printers)



ORDER FORM

Product	Price	Qty.	Total
_____	_____	_____	£ _____
_____	_____	_____	£ _____
_____	_____	_____	£ _____
_____	_____	_____	£ _____
_____	_____	_____	£ _____
_____	_____	_____	£ _____
_____	_____	_____	£ _____
_____	_____	_____	£ _____

SEND DETAILS ON _____

TOTAL SUM ENCLOSED (Cheque or credit card no.) £ _____
ALL PRODUCTS ARE BRAND NEW, BOXED AND OFFERED WITH FULL MANUFACTURERS WARRANTY. All prices include VAT & delivery

MICROWARE

14 Charles Street Hanley Stoke-on-Trent (0782) 269 883

* 67 Westow St. Upper Norwood London SE19*
01-771 6373

637 Holloway Road London N19 5SS
01-272 6398

NOW OPEN

I enclose my order for the above products.

Name _____

Address _____

Signed _____

JIM NOTMAN reviews two faster-than-Acorn double density DFS chips

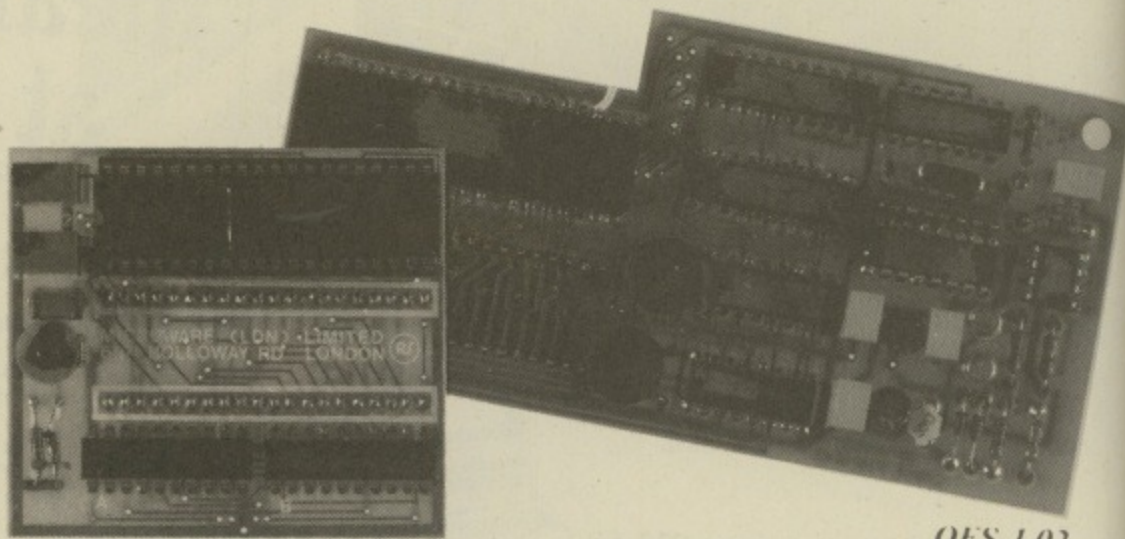

DDFS 0.98

QFS 1.02

QFS 1.02 Gnostic
DDFS 0.98 Microware

ONE of the deficiencies of the standard Acorn DFS is that it is based on the 8271 floppy disc controller chip. This is not only expensive and often in short supply but is also only a single density chip.

Information is written onto floppy discs in concentric tracks. Each track is divided into a number of sectors or blocks, each holding 256 bytes.

With the Acorn DFS 10 sectors are written to each track, so that with a 40 track system 100k of data can be put on one side of a disc. With 80 tracks 200k can be put in the same space.

Now density as far as floppy disc controllers are concerned refers to how closely information can be put onto each track.

Double density doesn't necessarily mean that twice the number of sectors can be placed on each track.

Microware says that its DDFS has 16 sectors on a track while Gnostic says the QFS has 18 sectors to the track.

Both give a considerable improvement in storage capacity on a disc.

The BBC Micro was not designed for use with double density controller chips and these are not pin compatible with the standard 8251.

Because of this both companies have mounted their chips – along with some other components – on a printed circuit board that is plugged into the socket that the 8271 normally occupies.

The Microware board is small, about 2½in by 2½in. Fitting is easy – simply plug in the circuit board, interface chips and the DDFS. However, if you have an issue 3 or earlier board other changes will have to be made, no matter which DFS is to be fitted.

The Gnostic board is larger, about

5in by 2½in and has a higher component count. It plugs into the 8721 socket and the socket of IC87.

If there's a wire bridging link at S19 it will need to be cut, so that the wire connected to the central pad can be bent upright and a lead from the extra circuit board connected to it.

Although larger than the Microware board it is set more to the left, so that it is less likely to interfere with any other boards that may be added to the BBC Micro.

With both of them, if you want to use 80 track disc units or need to alter the default speed response of the drives a set of keyboard link switches will need to be fitted. You'll then be able to experiment with the BBC starting up in different screen modes.

Both systems have tried to appear to the user to be much like the Acorn DFS as possible, with similar commands and syntax, and giving all the facilities you would expect.

There is no problem if you get your single and double density discs mixed up. The *CAT heading information is increased to say whether they are single or double density. Both systems are able to sense in which density mode the disc is without help from the user.

This is especially important in being able to transfer programs and data between single and double density modes.

Here the *COPY command must be used rather than *BACKUP, as the

FASTCATS!

	QFS 1.02		DDFS 0.98		Acorn
	Single density	Double density	Single density	Double density	0.90
1 Open and close file *1000	4.2	4.2	4.1	4.2	4.2
2a Print 1000 numbers	6.6	6.2	6.5	6.2	15.1
2b Print 100 strings	26.7	24.4	26.7	24.8	59.6
3a Input 1000 numbers	5.5	5.5	5.5	5.5	13.0
3b Input 100 strings	25.2	23.4	25.6	23.8	55.2
4 BPUT 1000 bytes	3.4	3.3	3.5	3.3	4.9
5 BGET 1000 bytes	2.4	2.7	2.3	2.5	4.6
6 Move PTR 1000 times	2.2	2.2	2.2	2.2	2.3
7a Write test relative file	27.7	25.6	27.7	25.7	60.9
7b Read test relative file	26.0	24.0	26.0	24.4	56.8
8a Write relative file backwards	81.9	96.0	81.8	96.4	234.6
8a Read relative file backwards	47.4	39.1	47.2	40.3	97.5

Micro User benchmarks: how the three DFSs compare

latter produces a sector-for-sector copy, not possible with the different number of sectors in a track between single and double density.

Each of the double density systems is different, so if discs are written in double density mode they cannot be used in the other system.

The extra command common to both is *FORMAT. DDFS presents a page in Mode 7 with the various options possible. I found the display irritating after a while, mainly due to the large "active box" flashing all the time.

The QFS goes through a list of options one by one. A nice feature here was that there was an option to format both sides of the disc.

As you can see from the benchmarks, there is nothing to choose between the pair in terms of speed. They are both very much faster than Acorn DFS 0.90.

Here I must dispute one of the claims made on the packaging of the Microware system. It says that it is 30

per cent faster than Acorn's on file access. As the benchmarks show, this is often much better than 50 per cent faster.

Documentation is supplied with both systems. The Gnostic 72 page manual supplied was a copy of the BBC disc system User Guide with minor changes concerning the QFS. Fitting instructions and details of the format utility were on an eight page insert.

Microware's manual is also 72 pages long. It is a bit basic, containing details of all the commands in a similar style to the BBC guide but lacking information on file handling.

Although I've been looking at the 0.98 version of the DDFS, other versions are promised by Microware – in particular one which greatly increases the number of files from the 31 that the Acorn DFS allows. I look forward to seeing it.

As the information is stored in a different way in the double density mode

it would have been nice if extra utilities had been supplied either on disc or preferably in the DFS eprom, including VERIFY and a sector editor.

You can see that both of these systems look very attractive, being much faster and allowing discs to hold a lot more information. In most ways they are compatible with the Acorn system.

There is one major disadvantage. Software writers are becoming more and more devious with software protection.

Most use direct programming of the 8271 to accomplish this, so that unless all the 8271 commands can be fully implemented I'm afraid that it will also defeat a double density controller.

So if you have to rely on buying software which is protected, you'll have problems unless either the 8271 commands can be fully emulated or dealers are prepared to supply the software on double density discs for each of these systems.

MIKE MAHON takes a critical look at a handy sideways ROM attachment

Rom Box Micro Pulse

IS this the sideways ROM attachment we've all been waiting for? I'm afraid the answer is – not quite. But certainly it is a good try, and maybe the one which will suit a lot of BBC Micro users.

The trouble with the BBC Micro is that Acorn, having tempted us with the delight of an expandable machine with the possibility of adding up to 16 16k chips of extra software on-line, only provide four ROM sockets.

Furthermore, access to them requires the lid and keyboard to be removed – and a little bravery from the uninitiated – before chips can be replaced or removed.

I'm sure there are very good reasons for this "oversight", such as drain on power supply, security, safety and so on, but now with numerous sideways

ROMs on the market only four slots and inaccessibility becomes a problem.

A number of sideways ROM expansion boards are already available, but most have to be fitted, with varying levels of difficulty, inside the micro and therefore remain relatively inaccessible.

The Micro Pulse device is an external box which connects to the BBC Micro by a 28 way ribbon cable and easily detachable edge connector.

The 28 pin dil header to the cable simply plugs into one of the empty sideways ROM sockets in the micro between the operating system and Basic. The short (25cm) cable is then clamped when the computer's lid is screwed back on.

The ROM box itself measures approximately 20 x 11 x 6cm and is

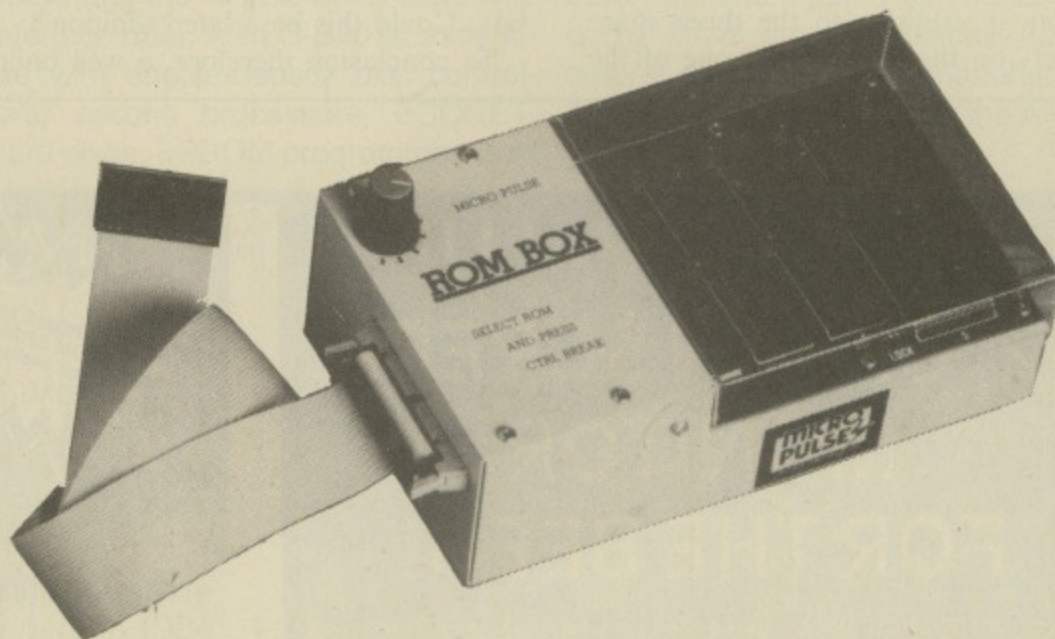

one of the best constructed BBC peripherals I have seen.

It is made of metal – painted BBC cream of course – and the eight ROM IC sockets are covered by a hinged clear lid. Seven of the sockets are standard dil type. They are similar to those on many other boards in being a bit stiff when trying to remove chips (usual advice – watch your legs!).

The remaining socket – numbered 5 – is an easy to use zero insertion force (ZIF) socket providing free and easy insertion and removal of ROMs.

A dial on top of the box allows the user to select the required ROM, which is then indicated by a red light. A two sided A4 instruction sheet provides

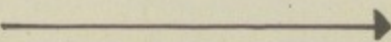

From Page 121

adequate fitting and user information.

The device worked well and caused no problems in use. It also performed correctly when attached to my internal ROM expansion board, and I was tempted to plug in all my 20 sideways ROMs at once. At last I could use my micro with the lid on once again.

There are, however, both advantages and disadvantages to the way the box works. It was useful to have only one (known) sideways ROM in operation at any one time, thus eliminating unwanted software interactions between chips, such as when two chips are using the same * command.

In practice I found myself using the single ZIF socket for this operation most of the time, replacing the desired chip when required without any danger to its legs.

The obvious disadvantage of the box is that, in addition to the three spare sockets on the micro, only one of the

'An ideal device for teaching and demonstrating purposes'

possible eight sideways ROMs may be in operation at a given time.

On turning the dial to select an alternative ROM a BREAK is often required to boot the new chip and thus previous information is lost.

This is especially troublesome if the new chip alters PAGE boundaries.

It is advised that Basic and filing system chips remain on board the computer. These may be major problems to program developers who wish to "attack" some software with a number of utility chips almost simultaneously. But for many users who simply want to select a word processor, database or spreadsheet the system is perfectly adequate.

Finally, there does not seem to be any facility to use sideways RAM on this box. Could this be a later addition?

In conclusion therefore, a well built

easily accessible external ROM Box for users who wish to select one ROM out of eight at a time.

Its transportability and sturdiness also make it an ideal device for teaching and demonstrating purposes and it will be a pity to lose this when the editor asks for it back.

Like all other ROM expansion boards it does fall short of my ideal, which would be for an external box carrying 16 independently switchable and co-existent ZIF sockets.

All sockets would be numbered and have indicator lights and could take ROM or RAM.

The system would also be lockable and have an inbuilt alarm set off by detachment or attempted software rip-off. Very useful at shows!

Is this just a dream, or can it be made at a reasonable price?

**A SUPER VALUE
12" GREEN SCREEN
MONITOR
FOR THE BEEB!**

That's right a good quality 12" green screen monitor for only £79.00 - it is fully supported by U-Microcomputers and available through your local dealer. Technical specs: 12" green screen, 90° deflection, composite video input, 15 MHz bandwidth. Use it with Apple, BBC micro or with most of the popular micros, for 40 column, 80 column or mono graphics.

To order:
5-1020 U-VIEW 12" green monitor.
Prices exclude VAT & delivery

£79.00

U-MICRO

U-Microcomputers Ltd
Winstanley Industrial Estate, Long Lane
Warrington, Cheshire WA2 8PR
Tel: 0925 54117 Telex 629279 UMICROG

Ask about quantity prices!

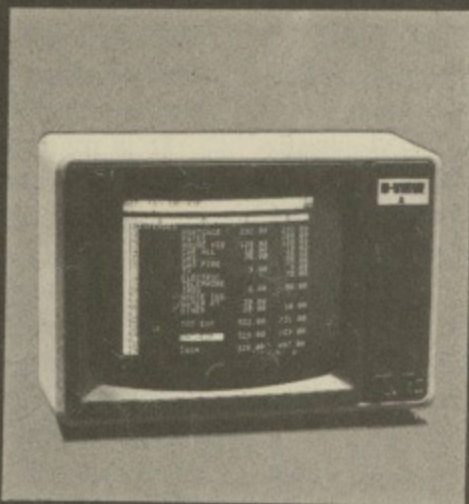

**Eprom Programmer
for the BBC Micro**

This compact, elegant unit combines the following attractive features:

- high quality, low cost
- easy-to-use 28 pin zero insertion force socket
- free 2764 eprom containing programming software - no cassette loading problems
- menu driven software incorporating the following commands: program, testblank, save, checksum, verify, select eprom
- programs 2764 and 27128 eproms as used on the BBC Model B machine
- built-in voltage converter
- integral cable connects to user port; no other connection needed
- comprehensive documentation plus one year's guarantee

This product is available in quantity **NOW!**
Programmer and data sheet from Softlife Ltd.
7 Rose Crescent, Cambridge CB2 3LL. Tel: 0223 62117

The Aries File

CRUSHED BETWEEN AN IRRESISTIBLE FORCE AND AN IMMOVABLE OBJECT?

If your high-resolution screen is squeezing you from one side, and your operating system from the other, isn't it time you tried the ARIES solution? ARIES-B20 is the board which banishes forever the conflict between screen graphics and program memory. "bad mode" and "No room" become nightmares of the past when your Beeb possesses this unique expansion.

Unlike "sideways-RAM" systems, ARIES-B20 offers you *transparent* access to 20K of extra memory, replacing the RAM swallowed up by the high-resolution graphics modes. The extra RAM is switched in completely automatically, meaning that your existing software can make use of it *without modification*.

This means that if you're a programmer, you have up to 28K RAM available for BASIC, FORTH, LISP, BCPL, LOGO and COMAL programs in *ANY SCREEN MODE*. If you're a business user, the extra memory is used by

VIEW, VIEWSHEET, WORDWISE and many other applications. And if you're a scientific type, you can get access to a massive 47K of data storage using the Acorn-approved ARIES ★FX call.

COMPATIBILITY ASSURED

With the huge range of Beeb add-ons that are becoming available, compatibility has become a real headache. Every extra you buy your computer might lock you out from a host of others, even if it works with those you already possess.

ARIES-B20, designed by BBC Micro experts, offers you true upgradeability. In addition to the rest of the ARIES family (the ARIES-B12 ROM expansion board and the ARIES-B488 IEEE-488 interface unit), ARIES-B20 is compatible with double-density disc controllers, second processors, ECONET, hard discs, EPROM programmers and

much more. Several major companies now test all their products with ARIES-B20 to ensure compatibility.

PROFESSIONAL QUALITY

The ARIES range is designed to work with *all* BBC Micros, not just some of them. This means it has a sensible regard for the capacity of the power supply and the natural variations in critical timings between machines. All new ARIES products are subjected to brutal testing in extreme conditions before they are released on the market.

In quality of construction, the ARIES range sets a standard against which others are judged. Custom-made connectors eliminate the damage to the BBC machine caused by inferior products. Units are electronically tested before, during and after manufacture. And all this is backed up by the ARIES 1 year no quibble guarantee.

WHAT THE PRESS SAID

"the most exciting add-on"
- Times Educational Supplement, March 1984

"a very professional product"
- A & B Computing, March/April 1984

"an attractive solution to the lack of sufficient memory on the Beeb"
- Beebug, March 1984

"this is an impressive piece of equipment in its own right and deserves to be taken seriously"
- Acorn User, April 1984

"the trouble with a paged RAM system is that the software has to be aware that it is there. The Aries RAM board gets round this limitation brilliantly"
- The Micro User, June 1984

NOW AVAILABLE THROUGH DEALERS

To cope with the continuing growth of demand, the unique ARIES-B20 RAM expansion has now been made available through selected dealers. Although ARIES-B20 can be fitted by a complete layman in a matter of minutes, a fitting service is offered by approved dealers to those customers unwilling to delve inside the case of their BBC Micro.

The recommended retail price of ARIES-B20 is just £79.95 (inc VAT) for the B20 board, operating system extension ROM and detailed manual. Enquire at your local dealer or order direct by post from the Manufacturers (see below).

(Machine requirements: Model 'B', MOS 1.2. Hardware plugs into CPU socket, software uses one sideways ROM socket)

How to order:

Send cheque or postal order made payable to:
Aries Computers
and forward to:

Aries Computers
Science Park, Milton Road,
Cambridge CB4 4BH
Telephone Cambridge (0223) 862614

Please send me (Qty.) ARIES-B20(s) at £79.95
(incl. P.P. & VAT)

I enclose a cheque/postal order made payable to
Aries Computers for £.

Signed

Name (block letters)

Address

Post Code.

SOLIDISK SIDEWAYS RAM: 8,000 UNITS SOLD

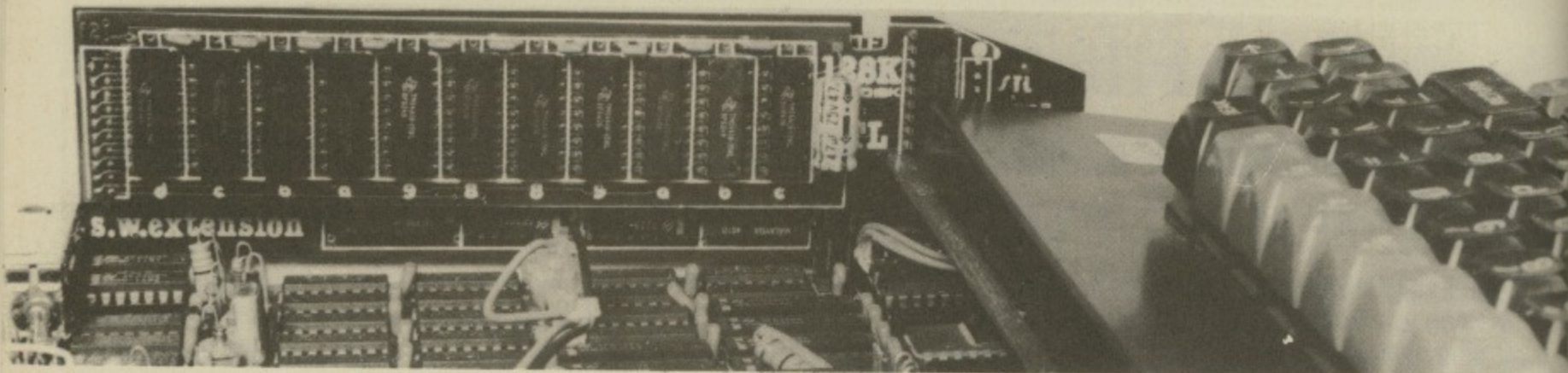

"Exciting" (ACORN USER JAN 84), "Power to your Beeb" (PCN 61, MAY 84)

HOW ABOUT COMPATIBILITY?

The Sideways RAM is completely compatible with all issues of BBC computers, disks, all sideways ROMs, second processor, Torch disk pack, Teletext, Econet etc. but NOT with ROM extension boards, since it can replace them.

Its power consumption is so low that you can use it in conjunction with twin disks.

HOW DOES IT WORK?

Occupying the same place as sideways ROMs (such as BASIC, DFS, CPN etc), it is treated like other Sideways ROMs and therefore can replace them.

The Machine Operating System uses Sideways RAMs as naturally as Basic, without procedures or programming rules.

Sideways RAM can run any language, any filing system including Hi-Basic and second processor DFS.

SIDEWAYS RAM POWER IS IN THE SOFTWARE:

Different from Sideways ROMs, Sideways RAM can be written into. This property gives birth to a NEW GENERATION of software for the BBC computer: SERVICE RAMs and VIRTUAL MEMORY PROCESSOR.

Each SERVICE RAM has its own commands and code as its counterpart Sideways ROM but has its own private workspace and storage area thus leaving you with the lowest possible PAGE value (PAGE=&E00). On the other hand, the Virtual Memory Processor can run huge MACRO BASIC programs (Megabytes are not the limit), keep them on disk and uses the basic 32k of RAM as transient program area. All software for the Sideways RAM system is free.

FREE SOFTWARE?

Solidisk Sideways RAMs is bundled with lots and lots of software, FREE and we mean FREE, now and later. It is quite simple: for every Sideways RAM sold, £1 is spent on MORE software. Sideways RAM users are invited to spot new applications and contributions are rewarded at the usual rate of £1 for every 4 bytes of machine code. The result is printed on the opposite page.

HOW ABOUT THE FUTURE?

Solidisk Sideways RAM is also widely used in schools for ECONET stations, by professional programmers for writing programs, research laboratories for RAM disk data base, at home for wordprocessing and now even games.

New areas are being developed: Telesoft and Teletext logging, Speech Processor assembler and Relational Data base to cite a few.

As the price of 16k EPROMs are as high as £20 at the present time, more Sideways ROM software publishers will be willing to sell their software on disk. Solidisk will mail FREE OF ANY COST their advertisement to ALL Sideways RAM users providing the price of the Disk version reflects savings in the cost of the ROMs. Solidisk believes that the majority of BBC users will have their Sideways RAM fitted before the end of next year.

Also unlike other makes (SIR, APTL, WE Sideways ROM/RAM extension boards and the Aries B20), Solidisk Sideways RAM is expandable from 16k right to 128k and now to 208K. As a result of VLSI technology and volume of sales, Solidisk products also have a lower shop price than any other products.

OTHER PRODUCTS FROM SOLIDISK:

UVIPAC EPROM ERASER:

Uvipac is powered by the mains, simple to operate and can erase 3 Eproms of any type in just 15 minutes. Uvipac is ideal for home use.

DETACHABLE KEYBOARD CASE:

Remove the keyboard from the BBC computer and instal it in the new case. Replace the old 3" keyboard tail by the new 24" cable and you can work really in comfort even for very long hours. The keyboard case is more a productivity tool than just ergonomics.

CPU CASE:

Replace the top of the BBC computer case by this metal CPU case. Sit your monitor on top (it is tough enough to take even your weight!). The CPU case has 2 compartments for half height 5.25" disk drives with fixing screws, air vents and provision for a bolt-on fan. At first sight, there is no trailing wire. Looking inside, there is enough room to accomodate Teletext Adapter, Second Processor, Solidisk and a fan!

DOUBLE DENSITY DISK INTERFACE:

2 versions of this double density interface will be available: as direct replacement for the Acorn Disk Interface (Version A) and as a Second Disk Interface (Version B) adding to your existing interface. They all use the same Western Digital controller chip (WD1770). Price £39.95 inclusive

DISK DRIVES:

3 models are being offered:

STL55A: 40 tracks single sided, SLT55F: 2 x 80 tracks, double sided and the best of mini floppy technology STL320: 2 x 160 tracks, double sided.

All disk drives are supplied with cables, formatter disk, head cleaning kit and 2 year warranty.

"Break the Ram Barrier" (A&B)

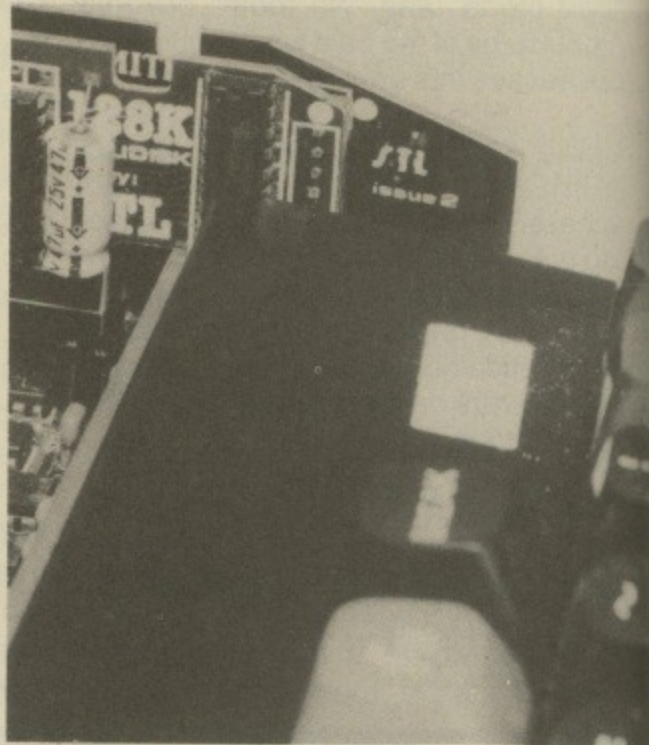

UVIPAC EPROM ERASER

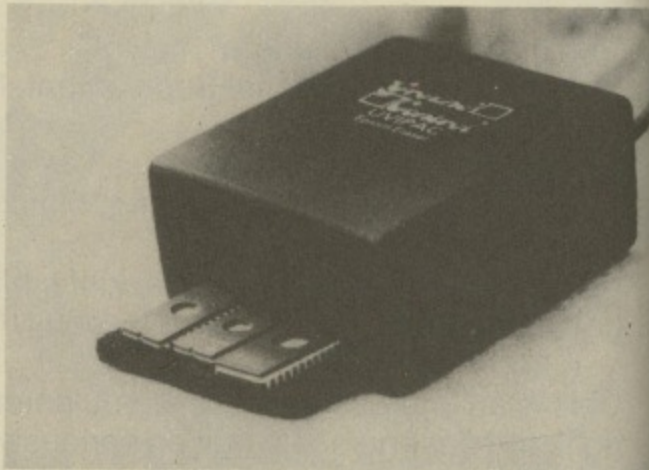

TEAC DISC DRIVES FD55 Series



WH

Solidisk (SWR3) and the now an SWR3 exchan

FREE S WORD WORD charac

SILEX SILEX a min words

PRINT PRINT to 15K long d

STLEC STLOC format

STL15 STL15 side.

STL-R STL-R applic onto E socket disks,

INDEX INDEX such a gives numb

MACR MACR which files a which

VIRTU VIRTU back s RAM a taking from t assem

MENU MENU Firma

MORE While with a sidew Each S warn Servic "It shou softwar the mos sided). S For the SILEXIC German Every u

HOW You c Acces Educa Name Addre

Credit

Callen

If orde once.

SOLI 17 SW SOUT ESSE

WHICH SIDEWAYS RAM DO YOU NEED?

Solidisk Sideways RAM is available in 16k (SWR16), equivalent to 1 sideways ROM, 32k (SWR32), equivalent to 2 sideways ROMs, 128k (Solidisk), equivalent to 8 sideways ROMs and the 208k Solidisk equivalent to 12 Sideways ROMs. You can buy a small Sideways RAM now and upgrade it later. From the SWR16 to the SWR32 is by straight exchange, from the SWR32 to the Solidisk is by adding the 96k Solidisk Extension, from 128k to 208k is by exchange of the RAM card.

FREE SOLIDISK SOFTWARE:

WORD64:
WORD 64 is a Service RAM, it uses Solidisk as storage for WORDWISE, up to 64K free characters for any text.

SILEXICON:
SILEXICON is a Spelling Checker for Solidisk. SILEX scans texts at more than a 1,000 words a minute and compares each word against the dictionary, Silexicon marks the mis-spelt words for either addition to the dictionary or eventual correction.

PRINTER BUFFER:
PRINTER BUFFER is a Service RAM, it increases 500 times the normal 32 bytes printer queue to 15K bytes, completely transparent to the user. PRINTER BUFFER is as useful for printing a long document as for a short program listing.

STLEOO:
STLOO is a Service RAM, it is Disk Filing System that leaves PAGE at &EOO, has built-in disk formatter/verifier and automatic track stepping for 40/80 track disk drives.

STL150:
STL150 is a Service RAM to enhance Acorn's .90 DFS to offer up to 150 directory entries per side.

STL-RFS:
STL-RFS (RAM/ROM filing system) is a Service RAM and an innovation in portable applications. STL RFS saves any program in a Sideways ROM format, it can then be copied onto EPROM to give instant recall of your programs. Plug this EPROM into any sideways socket, type *RFS and it runs itself. Compatible with the ELECTRON and BBC, tape and disks, SWR16, SWR32 and Solidisk.

INDEX:
INDEX is a Service RAM, it stores all the entry points of one or several sequential data files such as mailing list, stock list, accounts etc, merges, sorts them in alphabetical order and gives instant access to any record. INDEX can handle 1,100 records of any size, any type, any number of fields.

MACRO-BASIC:
MACRO-BASIC is a program generator. You use a wordprocessor to create a command file which is then scanned by MACRO. MACRO uses other programs, subroutine libraries, text files (actually any or all files on your disks) as source to generate a bug free BASIC program which can be very large (Megabytes are not the limit).

VIRTUAL MEMORY PROCESSOR:
VIRTUAL MEMORY PROCESSOR (VMP) uses extensively overlay technique and Solidisk as back store for very large programs that cannot be run otherwise. VMP uses the 32k basic RAM as transient area: it operates on a Main Program as generated by MACRO-BASIC, taking different segments from the Solidisk Store, POOL, HOLD, FREE or CLEAR segments from the transient area. For example: VMP will accept 20 segments of 10k of Basic assembler and assembles it into 16k of machine code.

MENU:
MENU puts all computer's resources at your fingertips. MENU displays your Sideways Firmware, Disk Directories, Sideways RAM system, Solidisk System etc.

MORE FREE SIDEWAYS RAM SOFTWARE TO COME:
While others are making promises for software to be written, Solidisk Systems RAM comes with a complete, novel and powerful software package including compatibility with existing sideways software.

Each Sideways RAM is accompanied by the Sideways RAM User Manual, full 1 year warranty, 1 utility disc* and free mailing on all new publications from the Software Support Service.

*It should be understood that we cannot put as much free software on a 40 track single sided as on a 80 tracks. The present software package require 160 tracks of storage and can be accommodated on ONE 2 X 80 track double sided diskette, only the most useful programs are supplied on other formats (ie 40 track single sided, 2 X 40 track double sided, 80 track single sided). Should you require the whole collection of free software, please place an order for extra disks. For the technical minded: the Source Code and Technical Manual (3 floppies and a 300+ page book) price = £10, the SILEXICON EXTENSION PACKAGE (3 floppies and a 40 page manual, 30,000 word dictionary: English and French now, German and Spanish planned) price = £9.00. '45' also publishes regular updated SWR utility discs at £3.00. Every user can do contract work for the SUPPORT SERVICE and make a lot of money for him/herself!

HOW TO ORDER?

You can order any item using the coupon. Post and packing is only charged once. Access and Barclay card holders can place their order by phone. Educational authorities, Acorn dealers and OEMs can obtain quantity discounts.

Name:
Address:

Credit Card Account:

Callers are requested to ring first for appointment.

Total: £
If ordering more than one item, deduct £1 per item as post and packing cost is only charged once.

SOLIDISK TECHNOLOGY LIMITED
17 SWEYNE AVE
SOUTHEND-ON-SEA
ESSEX SS2 6JQ

SOLIDISK'S NEW TELEPHONE NUMBER:
SOUTHEND-ON-SEA (0702) 354674
(10 lines with automatic exchange)

HOW EASY TO INSTALL:



Push in the base unit

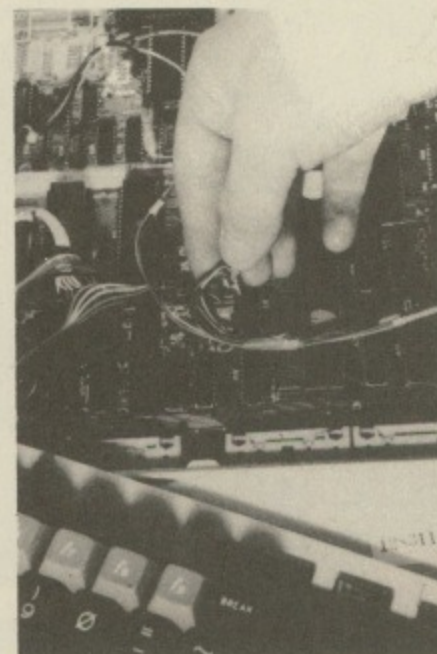

Connect the control wires

PRICE LIST (including VAT and post & packing)

SIDEWAYS RAM:	
SWR 16K	£43.65
SWR 32K	£59.95
128K SOLIDISK	£150.95
208K SOLIDISK	£243.00

The following are upgrade prices for existing Sideways Ram owners:
16 - 32 (please return complete item) £18.00
16 - SOLIDISK (please return complete item) £109.00
32 - SOLIDISK (no return necessary) £93.00
128K - 208K SOLIDISK £93.00

DISK DRIVES:	
STL55A (40 track, single sided, cased with cables, diskette, manual and 2 years warranty)	£142.95
STL55F (2 X 80 track, double sided, as above)	£232.95
STL320 (2 X 160 tracks, double sided, as above)	£499.00

FLOPPY DISKS (DATALIFE Verbatim):	
MD525 (SS/DD 40 or 80 track) box of 10	£16.00
MD550 (DS/DD 40 or 80 track) box of 10	£22.00
MD557 (DS/DD 98 TPI) box of 10	£27.00

CPU CASE	£13.00
DETACHABLE KEYBOARD CASE	£27.99

EPROM PROGRAMMER (used with Sideways Ram)	£16.00
UVIPAC EPROM ERASER (free standing unit)	£20.95
2764 PACK OF 5	£36.00

SOURCE CODE + TECHNICAL MANUAL	£10.00
SILEXICON EXTENSION PACKAGE	£9.00

WE STOCK A LARGE RANGE OF PRINTERS AND MONITORS. CALL OUR SALES OFFICE FOR IMMEDIATE QUOTATION.

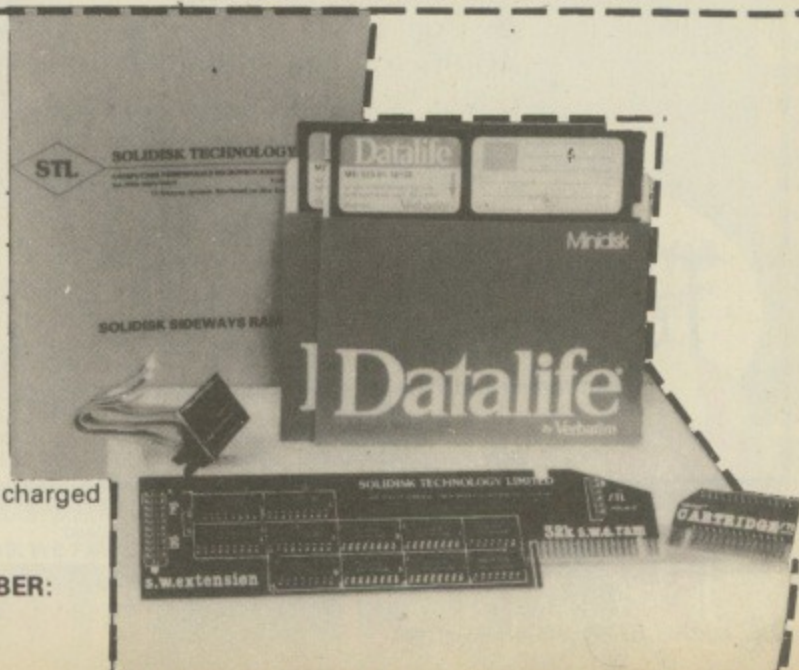

M I C R O P O W E R M I C R O P O W E R M I C R O P O W E R M I C R O P O W E R M

FROM THE AUTHOR OF THE TOP SELLING FELIX IN THE FACTORY

PLUTONIUM PLUNDER

Clear a path through the vault and shove the Radioactive Plutonium canisters behind the safety barrier before all hell breaks loose and the Megapods and oscillating Nuclids appear.
Cassette: £6.95. Disk: £9.95.



FOR THE
B.B.C. MICRO



M I C R O
P O W E R

MICRO POWER LTD.,
NORTHWOOD HOUSE, NORTH STREET,
LEEDS LS7 2AA TEL: (0532) 458800
MICRO POWER SOFTWARE IS AVAILABLE FROM
SELECTED BRANCHES OF WH SMITH, BOOTS, JOHN
MENZIES, CO-OP, WOOLWORTHS AND ALL GOOD
DEALERS.
AUTHORS! WE PAY 20% ROYALTIES!

"WATCH OUT
FOR THE FANTASTIC
NEW PACKAGING!!"



M I C R O P O W E R M I C R O P O W E R M I C R O P O W E R M I C R O P O W E R M

Beside the SEASIDE

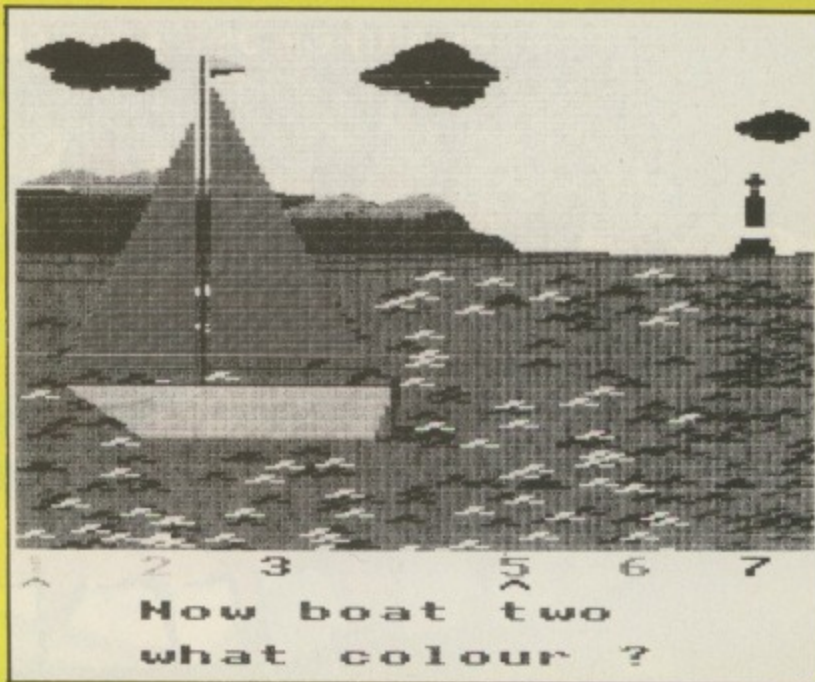

SEASIDE is an ideal introduction to using a computer for very small children.

Using a strictly controlled vocabulary, the child is encouraged to colour in a seascape featuring clouds, cliffs, boats and a lighthouse.

The idea is simple – but extremely effective. Try it, and you'll see why!

A similar program, called House, appears in our Micro User Educational Special. This contains 15 full length programs specially written for use by teachers and parents.

It is now on sale at newsagents, price £1.95. Or you can use the order form on Page 213.

VARIABLES

a% to g% Represent either a colour or number chosen.
 mx, my etc. x and y coordinates on graphics screen.
 r Radius
 c Colour of wave
 j Size of loop
 e,f,g,i Tab position on text screen.

PROCKEY

PROCpaint

PROCcloud (nx, ny)

PROCwave (c,d,mx,ny,r)

PROCTrees (qx,qy)

PROCFill (lj,wx)

PROCdraw

PROCpaint

PROCcircle (xc, yc, r)

PROCboy (xs, ys)

PROCBirds

PROCchara

PROCcharb

PROCstart.

PROCEDURES

Clears text screen and asks for any key to be pressed to go on.
 Sets up colours available with appropriate numbers.
 Draws and locates clouds.
 Draws, locates and sets up colour for waves.
 Draws and locates trees.
 Sets up with PLOT77 the loop to colour fill.
 Reads data in blocks of three for MOVE, DRAW or PLOT85 statements.
 Creates and positions pointers for preferred colours on text screen.
 Draws and fills a circle.
 Sets defined characters and locates boy in boat.
 Draws and locates birds.
 Defines character for tree and upper cloud.
 Defines character for lower cloud.
 Sets up graphics and text screens.

By **LEN SCOTT**

```
5 REM (C) The Micro User
10 MODE7
15 VDU23;B202;0;0;0;
20 PRINT TAB(5,2);CHR$(131);CHR$(1
41);"SHALL WE DRAW A PICTURE"
30PRINT TAB(5,3);CHR$(131);CHR$(14
1);"SHALL WE DRAW A PICTURE"
40 PRINT TAB(2,7);CHR$(131);CHR$(1
41);"A SERIES FOR CHILDREN AGE 4 TO 7
"
50 PRINT TAB(2,8);CHR$(131);CHR$(1
41);"A SERIES FOR CHILDREN AGE 4 TO 7
"
```

```
60 PRINT TAB(2,13);CHR$(131);CHR$(
141);" NUMBER TWO A SAILING BOAT"
70 PRINT TAB(2,14);CHR$(131);CHR$(
141);" NUMBER TWO A SAILING BOAT"
80 PRINT TAB(7,20)"written by Len
Scott"
90 PROCKEY
100 PRINTTAB(8,8)"NOTE TO TEACHER"
110 PRINTTAB(2,10)"When a selection
of colour is"
120 PRINTTAB(2,11)"asked for the ch
ildren can choose"
130 PRINTTAB(2,12)"any number from
```

```
1 to 9 .The"
140 PRINTTAB(2,13)"alternatives of
ferred are only in"
150 PRINTTAB(2,14)"my opinion the b
est combination"
160 PROCKEY
170 MODE 2
175 VDU23;B202;0;0;0;
180 PROCstart
190 PROCpaint
```

Turn to Page 169

**NEW!
FOR BBC
& ELECTRON**

**AVAILABLE
NOW!**

Super colour
graphics with six
skill levels & 48
screen
locations

1 WARP

COMING NOV 1st
BBC/ELECTRON/48K SPECTRUM



arcade fun as Santa delivers
the presents on Xmas eve...
overcome hostile snowmen,
flying snowballs, ice & icicles
etc. whilst consuming as much
cake & sherry as possible on the way.
Hi-res full colour graphics £7.95



BBC OR
ELECTRON

Zorakk the
Conqueror...
a strategical
fantasy
adventure
with full
colour
graphics.
£7.95

Space station
Alpha. A
full colour
space
battle with
3D graphics
£7.95

AVAILABLE
NOW

ORDER
BY POST

Access/Barclaycard
or send cheque/P.O.



Space...the final frontier...
as commander of a federation starship,
your mission is to seek out a fellow captain
who is lost in space. You must explore
strange new galaxies, fight and destroy
the enemy and boldly go where no man
has gone before.

BBC £7.95 ELECTRON £7.95

ICON

SOFTWARE

45 High Street, Gosforth, Tyne & Wear, Tel. (091) 2845966

Available from most major stockists, all good computer shops or direct from us.
Dealers contact Centresoft, Express.

OPENUP YOUR COMPUTERS POTENTIAL



WITH **BEL BASE** AND **MAILSHOT**
FROM **BEL TECH** FOR **BBC** AND **ELECTRON**

FLEXIBLE, POWERFUL, COMPREHENSIVE YET MENU DRIVEN AND EASY TO USE and INCREDIBLE VALUE FOR MONEY !!!

- * Up to 20 FIELDS and 480 CHARACTERS PER RECORD
- * 600 RECORDS or 90K Characters per File with truly RANDOM ACCESS Disc Version (10k/15K Characters per File on Tape)
- * DEFAULT Values can be set
- * SELECT Disc Drives (0 to 3)
- * CALCULATION Options. Calculate a Field from the value of others, enter Functions etc. — and change them!
- * SPECIFY number of decimal places on Calculated Fields
- * AMEND the Name, Type, Default Value of any Field
- * SEARCH and REPLACE on all Fields, all Records
- * SELECTIVE and GLOBAL EDITING of Records
- * INSERT Records, DELETE a Field or Record
- * BROWSE Option
- * FIND (Search on any Field) Print Screen if required
- * DISPLAY or PRINT Reports (max. 38/137 characters across)
- * PRINT all Records (2 Fields) or all Data
- * FORMAT OWN REPORTS (Heading, up to 20 Fields, select, sort etc.)
- * SORT on any Field (Ascending/Descending) whether Printed or not
- * SET CONDITIONS (<, >, <=>, =, >=, <=) on any Field, printed or not
- * SAVE Report Formats to a File
- * SUM Numeric Fields
- * SEND Printer Control Characters
- * COMPREHENSIVE INSTRUCTIONS SUPPLIED

NOW AVAILABLE ON ROM
MAILSHOT — £36
BEL BASE — £69



MAILSHOT IS INCLUDED IN PRICE OF BEL BASE AS A BARGAIN PACKAGE! !

PERSONAL USE, BUSINESS, ACCOUNTS, EDUCATION, CLUBS, SOCIETIES, FUNCTION, GENERATION — JUST KEEP THINKING OF NEW APPLICATIONS!



AND 'MAILSHOT' SEPARATELY:—

- * USE AS MINI DATA BASE
- * Field, Record Size, Amend, Edit, Search, Insert, Replace, Drive Selection, Browse, Find, Sort, Conditions, Printer Control as BEL BASE above.
- + * LABEL Printing (Std., non std, 1, 2, 3, across)
- + * PRINT any 8 Fields Across
- + * PRINT any 8 Fields Down

FILES ARE COMPATIBLE WITH BEL GRAPH ON DISC

Order Form	TAPE		DISC		TOTAL
	PRICE	QTY	PRICE	QTY	
BEL BASE	16.00		18.00		
BEL GRAPH	15.00		17.00		
BEL CHEM Chemistry 1	9.50		11.50		
Chemistry 2	9.50		11.50		
BEL GEN Geneology	15.00		17.00		
MAIL SHOT	9.50		11.50		
BEL PLOT	9.50		11.50		
BEL SUBS	10.50		12.50		

TOTAL inc. P. & P. £

NAME _____
 ADDRESS _____

 COMPUTER TYPE _____ MODEL _____
 DISC (if applic.) _____
 CREDIT CARD No. PAYMENT BY CHEQUE, P.O., VISA, ACCESS _____

Please Complete & Return to:-
 BEL TECH Limited, Stanmore Industrial Estate, Bridgnorth, Shropshire, WV15 5HP or
 Telephone: 07462 5420 (24 Hrs.)

DOUBLE MEASURE...

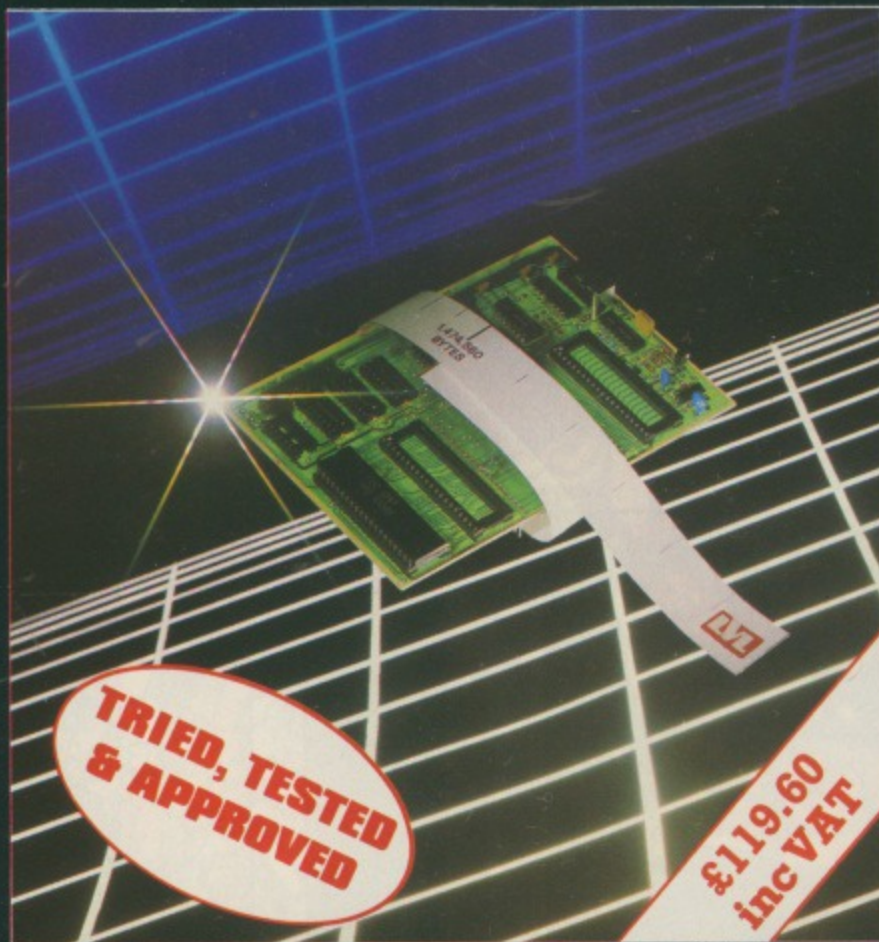

AVAILABLE FROM ALL LVL DEALERS. (FOR FURTHER INFORMATION TELEPHONE 0602 394000)

Twice as much storage capacity on your present or proposed discs.

The LVL *true double density* printed circuit board offers an amazing 1,474,560 Bytes of on-line storage, on a twin 80 track double density drive.

Removed is the 8271; (it is not capable of supporting double density). In it's place, a small printed circuit board with a new disc controller and support circuitry provides a much improved data retrieval.

This drastically reduces read errors by using a phased locked loop data separator, which is superior to the standard window circuit.

Your BBC micro will now recognise the media density in the drive, and inform you if it is correct. You may define what density you require, 40 or 80 track, and which sides of the disc to use.

The device gives complete flexibility and comes with an Eprom containing firmware; manual, and a 40/80 track utilities disc. On a dual drive it is simplicity itself to copy existing software from single density to double density.

- Double Density
- Automatically checks for correct density
- No 8271 (Rare & expensive)
- Utilities provided
- Defaults to single density on power up
- 40 or 80 track
- Own PCB with separate 8Mhz clock
- Simple to fit
- User definable density
- Phase lock loop data separator circuit.



Scientific House,
Bridge Street, Sandiacre
Nottingham. NG10 5BA
Telephone (0602) 394000

acters

CH
are

TOTAL

MODEL

ACCESS

Bridgnorth

s.)



THE LEADER

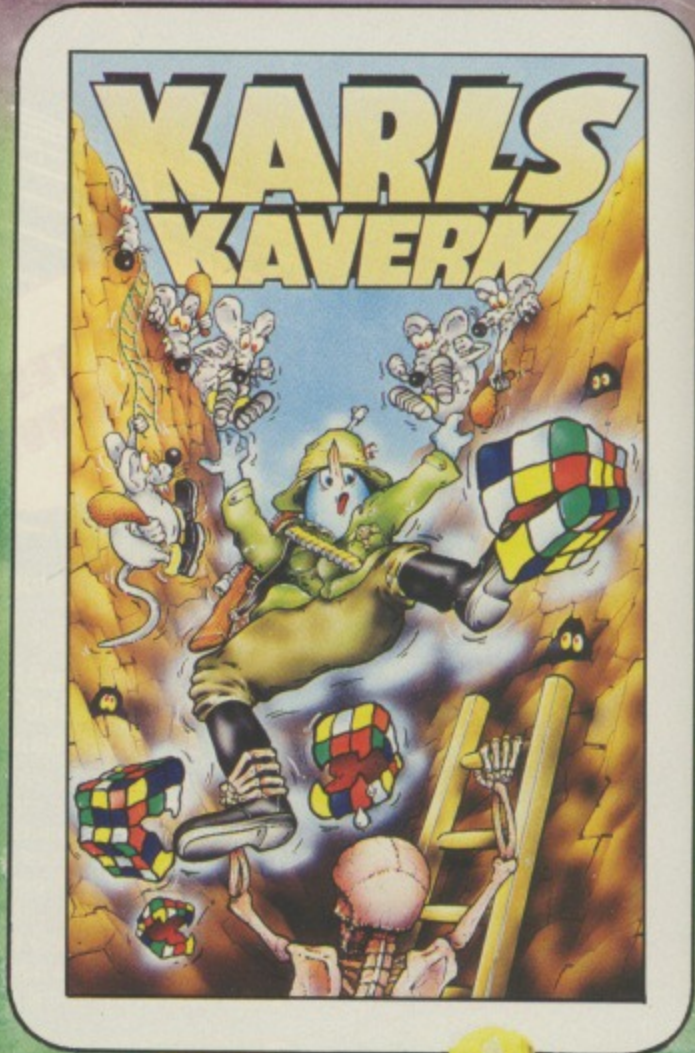

Miner Willy, while prospecting down Surbiton way, stumbles upon an ancient long forgotten mine-shaft. On further exploration, he finds evidence of a lost civilisation far superior to our own, which used automatons to dig deep into the earth's core to supply the essential raw materials for their advanced industry. After centuries of peace and prosperity, the civilisation was torn apart by war, and lapsed into a long dark age, abandoning their industry and machines. Nobody, however, thought to tell the mine robots to stop working, and through countless aeons they had steadily accumulated a huge stockpile of valuable metals and minerals, and Miner Willy realises that he now has the opportunity to make his fortune by finding the underground store.

In order to move to the next chamber, you must collect all the flashing keys in the room while avoiding nasties like poisonous pansies, spiders and slime and worst of all, manic mining robots. When you have all the keys, you can enter the portal which will now be flashing.

After being left a disused treasure mine by a long forgotten uncle, Karl decides to explore his new acquisition. As he nears the entrance to the mine the excitement builds up and once inside he shouts for joy, but alas the sudden noise after so many years of deadly silence starts a rock fall which blocks the entrance and seals Karl in the cave without any visible means of escape. By chance he discovers that if he collects all the boxes in each cavern he is automatically transported to the next one. In total he has to travel through thirty different caverns, can you help guide Karl to freedom.

Send a large stamped addressed envelope for more detailed information on our new releases, plus a free large poster.

**All sales enquiries to:
Colin Stokes, (Sales and Marketing).**

**For Mail Order only:
Software Projects, P.O. Box 12, L25 7AF.**

Selected titles available from: John Menzies, HMV, Boots, Woolworth, Spectrum and other large department stores and all good major software retailers.

One day wh
discover an
Once insid
several tre
not-as man
the pyrami
the doors.
Anyhow yo
to reach th
will find ol
items. Ren
destructabl
find for arc

All gar

Softwa
Allertoc
Telex:

OF THE PACK

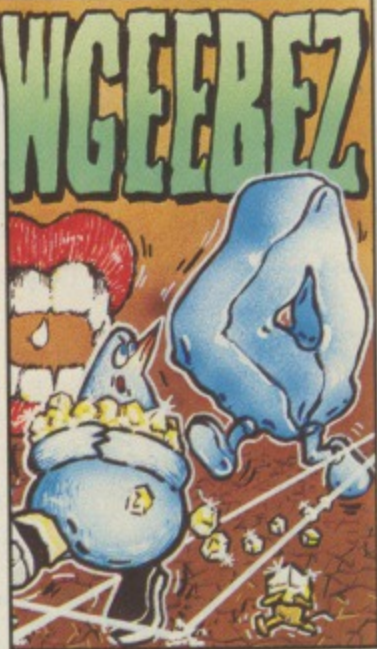
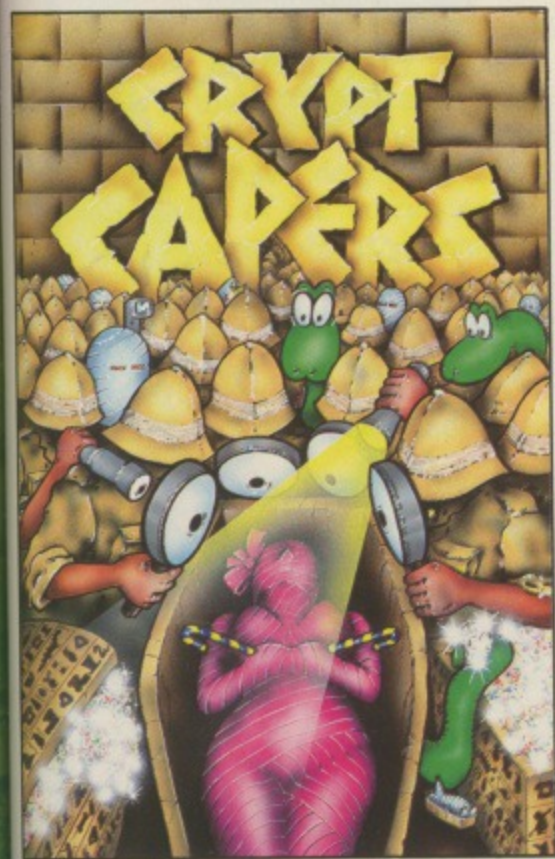

Today while you are studying Ancient Egyptian ruins you discover an unknown pyramid in the sands of the Sahara. Inside you are standing in a chamber containing several treasures, perhaps you would wish that there were no snakes and fireballs around. To get deeper into the pyramid you must collect the keys you find and unlock the doors. Beware of the Triads and shrinking ghosts. Now you have your gun and it should not be impossible to reach the Pharaohs chamber on level 12. On your way you will find old jars, statues, papyrus roots and other valuable items. Remember do not stand in the way of the magic non destructible rocks or you might end up being a surprise for archaeologists in a few thousand years from now.

11 games £7.95 each.

Penguin graphics is a logo type language for the BBC Micro. This language has been written to allow anybody, even newcomers to micro computing, to write logo or turtle graphics within a very short time of experimenting with the program. A large and comprehensive manual is provided with your purchase as are many working demonstrations of the capabilities of Penguin graphics. As well as being very educational, this program is also very entertaining and will provide endless hours of enjoyment.

Zelbob the Melkon has been marooned on the space station Ewgebez. To escape he must collect twelve power crystals to activate the main teleport which he must find in the mass of corridors which lie before him. Easy enough task you think to yourself but you haven't taken into account the alien creatures which regularly teleport in from a neighbouring foreign planet and of course the space stations own defence mechanisms, the patrolling robots with deadly laser beams.

After Ledgeman arrives home from the village auction with his bargain of the day, a Victorian bureau he decides to dust away the cobwebs and put all his important papers and documents into the top drawer. On opening the second drawer he is astonished to find a map. The map gives directions to a hidden cave where precious stones can be gathered in abundance, however the map also warns of the strange and perilous guardians of the cave, sentient barrels, meteor storms and a host of wandering nasties. The explorers blood in ledgies veins is stirred and armed with his trusty umbrella, he sets off.

SOFTWARE PROJECTS

Software Projects Limited, Bearbrand Complex,
Berton Road, Woolton, Liverpool L25 7SF.
Telex: 627520. Telephone: 051-428 9393 (4 lines).

Please send me a copy of

I enclose cheque/PO for
(please add £1.00 for orders outside UK)

Access Card No

Name.....

Address.....

.....

For Mail Order only: Software Projects Ltd. P.O. Box 12, L25 7AF



FOR THE BBC 32K O.S. 1.2

Castle of Gems

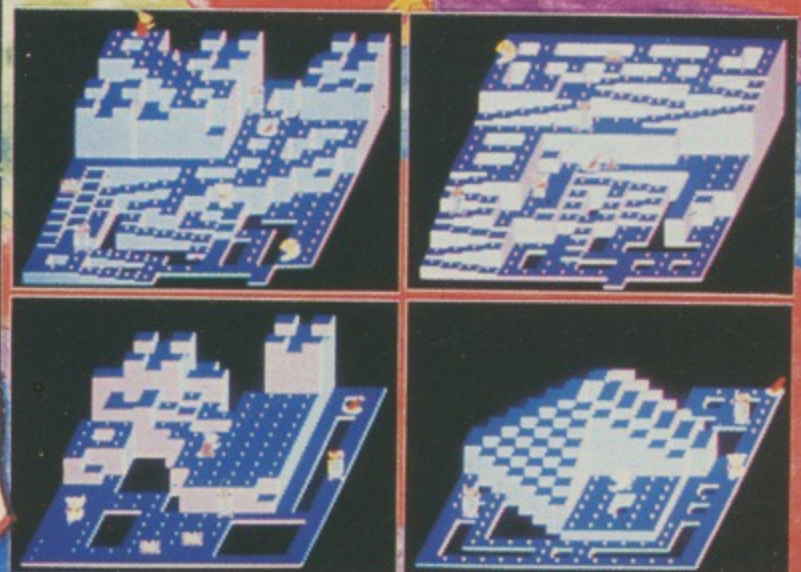
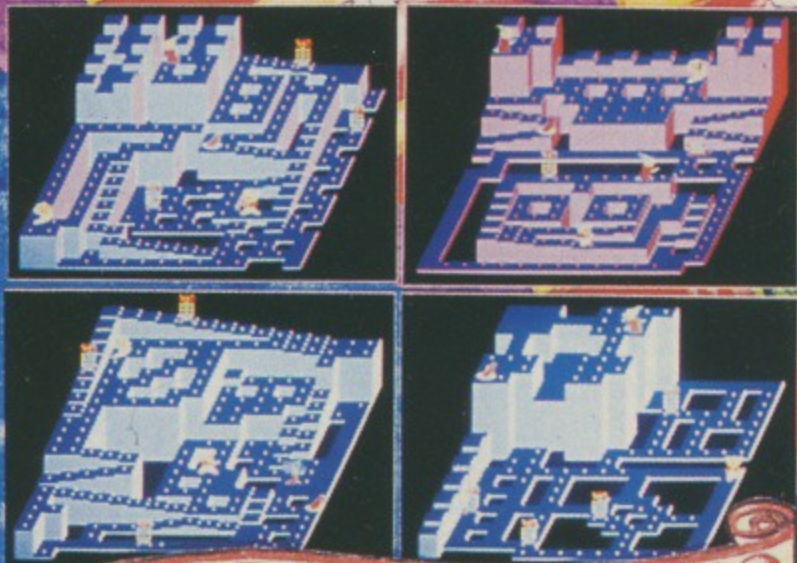

18 SCREENS

WORM
SOFTWARE

Castle of Gems
only £5.70 Fully
Inclusive

MRM SOFTWARE
17 Cross Coates Road
GRIMSBY
South Humberside
Telephone: 0472 44304

Part III of PETER JOHNSON's examination of the extra instruction set available on the second processor

THE HIBASIC that comes with the BBC Micro's second processor is a version of Basic specially written for machines being exported to the USA. It is assembled to run at &B800 and to list COLOR as COLOUR (try it!).

As it is intended for NMOS machines only – such as the second processor is – in order to use the enhanced 65C02 codes it is necessary to resort to poking them into the program with the EQUW and EQUW pseudo-operations.

Here I describe two ways of doing this, a simplistic one and a more sophisticated method which produces properly formatted listings.

The first method simply involves defining a lot of constants, which are the opcodes of the new instructions, and using EQUW to insert them into the program.

Operands may be inserted with EQUW or EQUW, depending on their length. Some of the operations don't have any operand bytes, so only need the initial EQUW.

Here is an example of the swap X and Y sequence given earlier. This is particularly straightforward as all the instructions are implied addressing mode ones:

```

100 phy=&5A : ply=&7A
110 phx=&DA : plx=&FA
120 FOR pass=0 TO 3 STEP 3
130 PX=&3000 : REM or whatever
140 [ OPT pass
150 .code \ lots of code
160 \ .....
170 .swapxy EQUW phy
180 EQUW phx
190 EQUW ply
200 EQUW plx
210 \ .....
220 ]
230 NEXT pass

```

A more meaty example would be to go through 16 bytes of memory, zeroing each byte if both bits 6 and 7 are set, while preserving the accumulator.

This would be written:

```

LDX #15 \ Do sixteen
          bytes
.loop BIT table,X \ Get state of N
              and V
          BVC miss \ V=0 so ignore
          BPL miss \ N=0 so ditto
          STZ table,X \ Zero the byte
.miss DEX \ next byte
          BPL loop
          .....
.table

```

To translate this into Basic we need the codes of BIT abs,X and STZ abs,X (we assume that the table is not in zero page). The program to assemble this code is:

```

100 bitax=&3C : stzax=&9E
110 FOR pass=0 TO 3 STEP 3
120 PX=&3000 : REM or whatever
130 [ OPT pass
140 LDX #15
150 .loop EQUW bitax : EQUW table
160 BVC miss
170 BPL miss
180 EQUW stzax : EQUW table
190 .miss DEX
200 BPL loop
210 \ .....
220 .table
230 ]
240 NEXT pass

```

As a final example of this technique the BRA instruction is illustrated. This

Let your macros do the talking

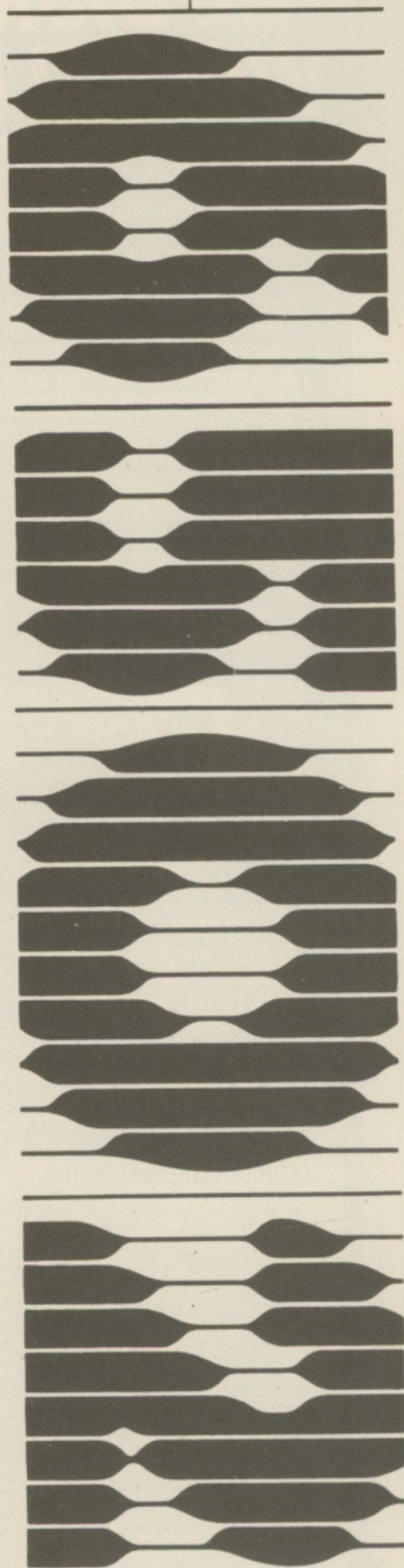

SECOND PROCESSOR

THE DISK DRIVE YOUR MICRO WOULD CHOOSE FOR ITSELF

THE TEAC 5¼" DISK DRIVE FOR THE BBC 'B' MICRO

Any self-respecting BBC 'B' Micro seeking a disk drive of high reliability and performance would immediately identify the TEAC 5¼" as the complete solution. A quality product, it is extensively industry-proven in major systems applications all over the world.

Now available for the home, educational or office user by mail order from Computamate, the TEAC 5¼" Disk Drive guarantees trouble-free high speed data access every time: and what more could a micro ask?

- Single and dual models available with capacities up to 800K. (All 80 track models are switchable 40/80).
- Supplied with leads, utility disk, instructions: ready for use with your BBC 'B' Micro DFS Disk Interface.
- Oatmeal moulded box to match your micro.
- Fully stackable, plus extending tilt-action "legs" to ease disk insertion.
- 12 months parts and labour warranty.
- Computamate is supported by the resources of a major multi-national public company.

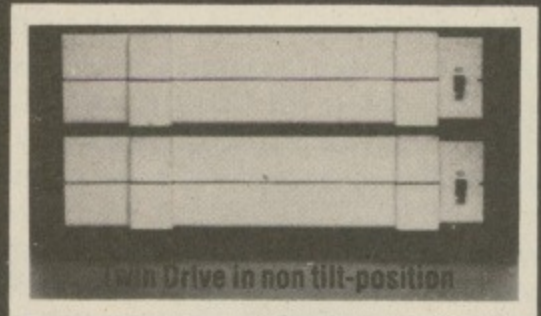

Twin Drive in non tilt-position

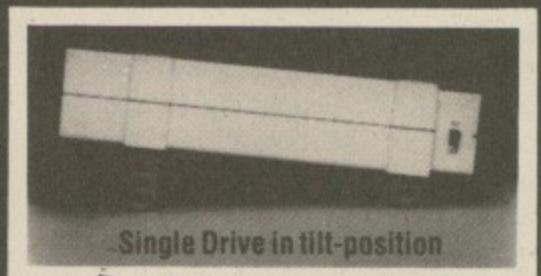

Single Drive in tilt-position



How to order:

By post – complete the coupon with your requirements and return to:
Dept. MU 11, Computamate Data Products, Scotia Road, Burslem, Stoke on Trent, ST6 4DX
 Enclose your cheque/P.O. (made payable to Computamate) or use your Access/Barclaycard number.

By telephone – ring 0782-811711 to purchase by phone (credit card holders only).

SATISFACTION GUARANTEED
 OR WE WILL REFUND
 YOUR MONEY.

computamate

(Computamate Data Products is a division of Thomas French and Sons PLC)

INTRODUCTORY PRICES ONLY

SINGLE DRIVES	COST (Incl. VAT)	QUANTITY	TOTAL (£)
FD-55A SS 40TK 100K	£108 10		
FD-55B DS 40TK 200K	£129 95		
FD-55E* SS80TK 200K	£135 70		
FD-55F* DS 80TK 400K	£164 45		
TWIN DRIVES			
FD-55A SS 40TK 100K	£212 75		
FD-55B DS 40TK 200K	£253 00		
FD-55E* SS80TK 200K	£253 00		
FD-55F* DS 80TK 400K	£309 35		
DUAL DRIVES (with integral power supply, available only in metal non-tilting box at present)			
FD-55A SS 40TK 100K	£301 30		
FD-55B DS 40TK 200K	£342 70		
FD-55E* SS80TK 200K	£343 85		
FD-55F* DS 80TK 400K	£399 05		
Post and Packing (First Unit)	£5 75		
Post and Packing (each additional unit)	£2 50		
*Price includes 40/80 switch			
MEDIA			
Box of 10 Diskettes 40TK SS	£18 50		
Box of 10 Diskettes 80TK SS	£21 25		
Box of 10 Diskettes 80TK DS	£27 00		
Postage & Packing per box of Diskettes	£1 00		

TOTAL £

Post to: Dept. MU11,
 Computamate Data Products, Scotia Road,
 Burslem, Stoke on Trent, ST6 4DX

Name _____

Address _____

Post Code _____ Telephone _____

*I enclose cheque/P.O. for £ _____

*Please debit my Access/Barclaycard Number _____

Signature _____

(Credit Card orders must be signed by the card holder. Address above must be the same as card holder)

*(Please delete as appropriate)

For further information on these products, or for details of other exciting products, including TEAC 3½" and 3" Disk Drives, telephone 0782 811711.

Enquiries from Dealers and Educational Authorities welcome.

From Page 135

is slightly different to the previous examples as the operand must be calculated from the destination label.

Consider the segment of code:

```
65C02
  BRA end
/.....
/.....
.end RTS
```

To translate this into a form the HiBasic assembler can use we first have to assign a constant *bra* with a value &80. (I use lower case for the opcode variables throughout this article, as mnemonics such as AND are illegal variable names.)

The code to perform the branch listed above is:

```
6502
  EQUB bra : EQUB end-(P%+1)
/.....
/.....
.end RTS
```

The expression *end-(P%+1)* is derived as follows: The operand of branch instructions is the displacement from the first byte of the instruction after the branch to the destination address.

When the expression after the second EQUB above is being calculated *P%* contains the address of this EQUB. Thus *P%+1* is the address of the instruction after the branch, and *end-(P%+1)* is the required difference. Simple, huh.

Note that the form *label-(P%+1)* is used even if "label" comes before the branch in the program. The expression will yield the necessary negative displacement.

A shortcoming of the current method is that "Out of range" errors are not detected. This is corrected in the longer version of BRA described below.

The techniques just described for implementing the 65C02 codes are serviceable but have a couple of shortcomings. One is that in assembly listings the new instruction is split over two lines if it has an operand.

The other problem is the lack of error detection in the BRA instruction, and in

instructions that need a single-byte operand.

A way of eliminating these shortcomings is to define the 65C02 instructions as short macros. A macro in assembler parlance is a pseudo-instruction which, when called, generates several real instructions.

In BBC assembler the OPT directive is used too in conjunction with user-defined functions to emulate a macro facility. (EQU can also be used, but is less convenient to use when trying to control the assembly listing).

To introduce the idea of macros a simple example will be presented, followed by details of the macros required to emulate 65C02 instructions.

It is quite common to find the sequence:

```
6502
  LDA code
  LDX address MOD &100
  LDY address DIV &100
```

in BBC assembler programs, for example, when calling the MOS routines OSFIND, OSFILE and OSWORD. Wouldn't it be convenient if we had an instruction to do this in one go? Like this:

LDREG code, address

This would save us the trouble of remembering the order of the MOD, DIV and so on. A macro may be written to do this for us:

```
6502
  OPT FNldreg(code, address)
/.....
/.....
]
NEXT
REM .....
END
DEF FNldreg(code, address)
[
  OPT pass
  LDA code
  LDX address MOD &100
  LDY address DIV &100
]
=pass
```

The OPT is used purely as a way to call FNldreg. It has the useful property that it generates no code, and so doesn't

interfere with the program. When the OPT is encountered Basic calls FNldreg in order to evaluate the operand. In FNldreg we have more assembly code, in fact the very same code that was given earlier.

So the net effect of all this mucking around with functions and OPTs is to generate the code we first thought of.

However the utility of having macros becomes apparent when they are called numerous times in the program. Each time this happens only the OPT line has to be typed. This saves time and reduces the possibility of typing errors.

Having followed this far you may have realised how macros can help in the implementation of 65C02 instructions. Here is the macro definition of the JMP (abs,X) instruction:

```
6502
DEF FNjmpax(addr)
[
  OPT pass
  EQUB &7C : EQUW addr
]
=pass
```

To do JMP (table,X), the instruction OPT FNjmpax(table) would be used.

The real power of macros isn't illustrated in the example above. Since the FN call has handed control temporarily back to Basic from the assembler, we can do useful things inside the function definition such as error checking and performing a "listing" of the instruction.

Look at the new version of FNjmpax:

```
1000 DEF FNjpinx(addr)
1010 [OPT pass AND 6
1020 EQUB &7C : EQUW addr
1030 ]
1040 IF (pass AND 1)=0 THEN =pass AND 6
1050 PRINT FNhex4(P%-3)FNhex2(&7C)FNhex2(addr);
1060 PRINT FNhex2(addr DIV &100)SPC(10)"JMP (&FNhex4(addr)",X)"
1070 =pass AND 6
```

The code is assembled in the same way as the last example, but the assembly listing is suppressed by

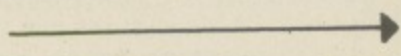



SATAN'S CHALLENGE

or (Nevil Rides Out) A Black Magic Adventure



Dare you take up the challenge laid down by the most evil and sinister of all beings . . . the devil himself.

If you do you will find yourself alone and at the mercy of the twisted fancies and whims of a cold and calculating mind.

Occult forces are threatening the lives of those near and dear to you. Their only salvation rests in your hands but in accepting the challenge your own existence is put in severe peril.

In taking up the challenge you have to find the TALISMAN and locate a pentagram which then has to be prepared for the final rite. In the mean time dark forces will be opposing you making a difficult task almost impossible.

Do not allow yourself to be lulled into a sense of security for it will be short lived.

Many have gone before only to swell the ranks of the damned. This is the latest adventure from the stables of Microtest and has been written with the acclaimed features of other adventures in mind eg save facility, quick response, simple but extensive commands, a mixture of logical and fiendish problems to solve.

Be warned this is an easy adventure to get into but devilishly difficult to end.

CASSETTE £7.95 inc VAT
DISC 40 or 80 tk £9.45 inc VAT (add 50p p&p)

DAIRYFILE FOR DAIRY FARMERS

Keep on that economic line between over and under feeding!
Save time recording milk yield and calculating feed amounts!
Quickly decide feeding policy with the 'Monthly Calving Group' Performance Graph!

Print out a recording sheet with cows in numerical order. Print out graphs or tables of individual cows or Monthly Groups showing serving and pregnancy details, illness record, Calving Index, weekly and running total Margin over Concentrate. See at a glance cows due for serving, pregnancy diagnosis and drying off. Keep track of

weekly total feed cost and milk sale price.

All this and more with DAIRYFILE.

Predict cow or Monthly Group total lactation yield. Compare with Standard Lactation Curves. All old data preserved - compare Monthly Groups over the years. Which is the most profitable month?

Find out with DAIRYFILE - for up to 200 lactating cows.

Available on dual 40 tk disc (For dual 40 tk drives only)

Dual or Single 80 tk drives **£69 inc VAT (add 50p p&p)**

Please state on ordering which disc format and printer model.

MICROTEST FONT ROM

This exciting new ROM from Microtest will enable you to get all sorts of new characters and fonts from your BBC Computer. Once you have produced your masterpiece on the screen, all you have to do is use the inbuilt screen-dump utility to produce a hard copy onto paper.

Typing '*HELP FONTS' gives a list of available fonts and the blocks of characters which they replace.

Available fonts are:

- *Accents Accents and miscellaneous.
- *Block Small capitals.
- *Data Like the bottoms of cheques.
- *Greek It's all Greek to me too!
- *Joined Standard capitals with joined up lower case.
- *Maths A mix of until now unobtainable Mathematical symbols.
- *Miscellaneous A few oddities which often are very necessary.
- *Thick Thick text (for MODEs 0&3) to enhance 80 column mode.

*Thin Thin text (for MODEs 2&5) which makes modes 2 & 5 much more readable or perhaps "READABLE".

*Vertical For labelling graphs.

*MODE 8 Ten column multicolour, memory-miserly mode.

*S DUMP A dump facility which will produce a screen dump of any MODE from 0 to 8 (including a text only dump in MODE 7) on an Epson, Star, CTI CP80 or MT80.

The ROM uses absolutely NO user memory and can be used with word processors etc. as well as normal BASIC programs. The DUMP utility will produce positive or negative graphics and will also rotate the picture produced through 90° as well as being able to position the picture anywhere laterally across the sheet of paper.

£17.50 inc VAT (add 50p p&p)

Microtest Starstick ROM & Joystick Package

Now available the Starstick ROM and Joystick. This comes in three forms:



Enables you to use our joysticks on most programs even those that do not offer joystick capability.

(A) The Starstick ROM and Quickshot I Joystick

Price 17.95 + VAT = 19.84

(B) The Starstick ROM and Quickshot II Joystick

Price 19.25 + VAT = 22.14

(C) The Starstick ROM and patch lead, choose your own Spectrum/Atari style joystick

Price 15.25 + VAT = 17.54

Post and Packing £1.00 inc. VAT per item

This enables you to plug the Rapid action self centring joysticks until now only available for the Spectrum/Atari/CBM machines into the user port of the BBC. Model A users please note NO ANALOGUE INTERFACE REQUIRED.

Disc Users Note - pressing BREAK, SHIFT-BREAK or CONTROL BREAK does not modify or destroy the STARSTICK software so Disc Users please feel free to Boot!

The software patch provided in the ROM is interrupt driven and adds the following commands to your computer.

The software patch provided in the ROM is interrupt driven and adds the following commands to your computer.

- * STICK turn on the STARSTICK ROM
- * NSTICK turn off the STARSTICK ROM
- * SETSTICK set up joystick to users spec
- * SAVE "NAME" 140 160 saves your user-key protocols
- * ADVAL emulate standard analogue joysticks
- * PAUSE define key to Freeze game
- * NPAUSE turn off ability to freeze game
- * "NAME" predefined key protocols set up for software houses programs
- * HELP KEYS displays currently selected key protocols
- * REPEAT enables auto-repeat fire
- * NREPEAT disables auto-repeat fire



available from

MICROTEST LTD

18 Normandy Way, Bodmin, Cornwall PL31 1EX

Telephone: 0208 3812

OR ANY GOOD DEALER

VISA



DEALER ENQUIRIES
and
EXPORT ORDERS
WELCOME

Large picture shows BBC Computer System and a Quickshot II Joystick. Small inset just a few of the joysticks that will work with the patch lead. Screenshot by kind permission of SUPERIOR SOFTWARE

All MICROTEST ROMs are fully TUBE® compatible. (TUBE® is a reg. trademark of Acorn Computers).

From Page 137

masking out the lowest bit of the pass number. The IF returns immediately if no listing is required.

If the lowest OPT bit is set the PRINT statements give a listing compatible with that produced by the assembler. The functions FNhex2 and FNhex4 are assumed to return strings of

their arguments in hex with leading zeroes and a trailing space.

To use the macro defined earlier, a sequence of the form:

```
6502
OPT FNjmpinx(&1234) : OPT pass
```

would be used. The second OPT is needed as FNjmpinx turns off the listing in order to suppress the first OPT.

If pass equalled 3, this listing would

be given:

```
3000 7C 34 12 JMP (&1234, X)
3003 OPT pass
```

Rather than bore the reader with more tedious examples, I present below the complete suite of macros implementing the 65C02 additional instructions. The techniques involved are identical to the one described above, and the macros are called in the same way.

```

10 REM Definitions of 65C02 opcodes, early in the program
20 bra=&80
30 oraInd=&12 : andInd=&32 : eorInd=&52 : adcInd=&72
40 staInd=&92 : ldaInd=&82 : cmpInd=&D2 : sbcInd=&F2
50 tsbZp=&04 : tsbAbs=&0C : trbZp=&14 : trbAbs=&1C
60 bitZpx=&34 : bitAx=&3C : bitImm=&89
70 stzZp=&64 : stzAbs=&9C : stzZpx=&74 : stzAx=&9E
80 jmpInx=&7C
90 incA=&1A : decA=&3A : phy=&5A : ply=&7A
100 phx=&DA : plx=&FA
110 FOR pass=0 TO 3 STEP 3
120 PZ=&3000
125 [OPT pass
126 \ For example
127 OPT FNjmpinx(table)
128 OPT FNdecA
129 OPT FNstaInd(&70) : OPT pass
130 RTS
131 .table
140 ]
150 NEXT
160 END
10000 DEF FNbra(addr)
10010 disp%=addr-(PZ+2)
10020 [ OPT pass AND 6
10030 EQUB bra : EQUB disp%
10040 ]
10050 IF pass AND 2 AND (disp%<-128 OR disp%>127) THEN PRINT"Out of range":STOP
10060 IF pass AND 1 THEN PRINT FNhex4(PZ-2) "FNhex2(bra)" FNhex2(disp%15) TRING$(14, " ") "BRA &FNhex4(addr)
10080 =pass AND 6
10090
10100 DEF FNoraInd(addr)=FNind(addr, oraInd, "ORA")
10110 DEF FNandInd(addr)=FNind(addr, andInd, "AND")
10120 DEF FNeorInd(addr)=FNind(addr, eorInd, "EOR")
10130 DEF FNadcInd(addr)=FNind(addr, adcInd, "ADC")
10140 DEF FNstaInd(addr)=FNind(addr, staInd, "STA")
10150 DEF FNldaInd(addr)=FNind(addr, ldaInd, "LDA")
10160 DEF FNcmpInd(addr)=FNind(addr, cmpInd, "CMP")
10170 DEF FNsbcInd(addr)=FNind(addr, sbcInd, "SBC")
10180
10200 DEF FNind(addr, opcode, mnen%)
10220 [ OPT pass AND 6
10230 EQUB opcode : EQUB addr
10240 ]
10250 IF pass AND 2 AND addr>&FF THEN PRINT"Byte":STOP
10260 IF pass AND 1 THEN PRINT FNlist1(PZ-2, opcode, addr, mnen%+" (")")
10270 =pass AND 6
10280
10290 DEF FNtsbZp(addr)=FNzpx(addr, tsbZp, "TSB")
10300 DEF FNtsbAbs(addr)=FNnabs(addr, tsbAbs, "TSB")
10310 DEF FNtrbZp(addr)=FNzpx(addr, trbZp, "TRB")
10320 DEF FNtrbAbs(addr)=FNnabs(addr, trbAbs, "TRB")
10330 DEF FNstzZp(addr)=FNzpx(addr, stzZp, "STZ")
10340 DEF FNstzAbs(addr)=FNnabs(addr, stzAbs, "STZ")
10350
10360 DEF FNzpx(addr, opcode, mnen%)
10380 [ OPT pass AND 6
10390 EQUB opcode : EQUB addr
10400 ]
10410 IF pass AND 2 AND addr>&FF THEN PRINT"Byte":STOP
10420 IF pass AND 1 THEN PRINT FNlist1(PZ-2, opcode, addr, mnen%+" ")
10430 =pass AND 6
10440
10450 DEF FNabs(addr, opcode, mnen%)
10470 [ OPT pass AND 6
10480 EQUB opcode : EQUW addr
10485 ]
10490 IF pass AND 1 THEN PRINT FNlist2(PZ-3, opcode, addr, mnen%+" ")
10500 =pass AND 6
10510
10520 DEF FNbitZpx(addr)=FNzpx(addr, bitZpx, "BIT")
10530 DEF FNbitAx(addr)=FNax(addr, bitAx, "BIT")
10540 DEF FNstzZpx(addr)=FNzpx(addr, stzZpx, "STX")
10550 DEF FNstzAx(addr)=FNax(addr, stzAx, "STX")
10551
10552 DEF FNbitImm(val)
10553 [ OPT pass AND 6
10554 EQUB bitImm : EQUB val
10555 ]
10556 IF pass AND 2 AND val>&FF THEN PRINT"Byte":STOP
10557 IF pass AND 1 THEN PRINT FNlist1(PZ-2, bitImm, val, "BIT #")
10558 =pass AND 6
10560
10570 DEF FNzpx(addr, opcode, mnen%)
10590 [ OPT pass AND 6
10600 EQUB opcode : EQUB addr
10610 ]

```

From Page 139

```

10620 IF pass AND 2 AND addr>&FF THEN
PRINT"Byte":STOP
10630 IF pass AND 1 THEN PRINT FNlist
1(P%-2,opcode,addr,mnem$+" "),"X"
10635 =pass AND 6
10640
10650 DEF FNax(addr,opcode,mnem$)
10670 [ OPT pass AND 6
10680 EQUB opcode : EQUW addr
10690 ]
10700 IF pass AND 1 THEN PRINT FNlist
2(P%-3,opcode,addr,mnem$+" "),"X"
10710 =pass AND 6
10720
10730 DEF FNjmpInx(addr)
10750 [ OPT pass AND 6
10760 EQUB jmpInx : EQUW addr
10770 ]
10780 IF pass AND 1 THEN PRINT FNlist
2(P%-3,jmpInx,addr,"JMP ("),"X")

```

```

10790 =pass AND 6
10800
10810 DEF FNincA=FNimp(incA,"INC A")
10820 DEF FNdecA=FNimp(decA,"DEC A")
10830 DEF FNphy=FNimp(phy,"PHY")
10840 DEF FNply=FNimp(ply,"PLY")
10880 DEF FNphx=FNimp(phx,"PHX")
10890 DEF FNplx=FNimp(plx,"PLX")
10900
10910 DEF FNimp(opcode,mnem$)
10930 [ OPT pass AND 6
10940 EQUB opcode
10950 ]
10960 IF pass AND 1 THEN PRINT FNlist
0(P%-1,opcode,mnem$)
10970 =pass AND 6
10980
10990 DEF FNlist0(p%,opcode,mnem$)
11000 =FNhex4(p%)+ " "+FNhex2(opcode)+
STRING$(17," ")+mnem$
11010
11020 DEF FNlist1(p%,opcode,addr%,mne
m$)

```

```

11030 =FNhex4(p%)+ " "+FNhex2(opcode)+
" "+FNhex2(addr%)+STRING$(14," ")+mne
m$+"&"+FNhex2(addr%)
11040
11050 DEF FNlist2(p%,opcode,addr%,mne
m$)
11060 =FNhex4(p%)+ " "+FNhex2(opcode)+
" "+FNhex2(addr%)+ " "+FNhex2(addr%)/DIV
&100)+STRING$(11," ")+mnem$+"&"+FNhex
4(addr%)
11070
11080 DEF FNhex2(h%)=RIGHT$("0"+STR$~
(h%),2)
11090 DEF FNhex4(h%)=RIGHT$("000"+STR
$(h%),4)
11100
11110 DEF PROCerrar(err$) PRINT'err$'
:END

```

This listing is included in this month's cassette tape offer. See order form on Page 213.

KAY-ESS

COMPUTER PRODUCTS

PROFESSIONAL PROGRAMS FOR THE MODEL B AND ELECTRON

EACH TAPE ONLY £5.95 (Except H.O.H.)

HOUSE OF HORRORS (B)(E) £6.95

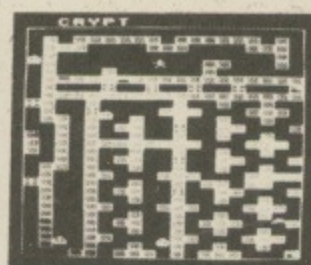
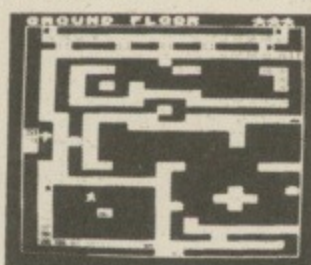
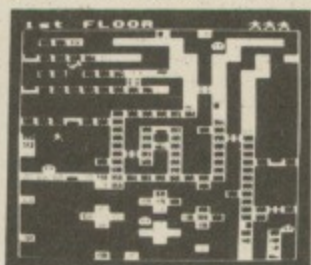
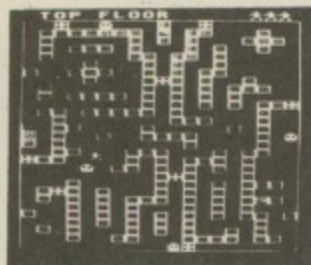
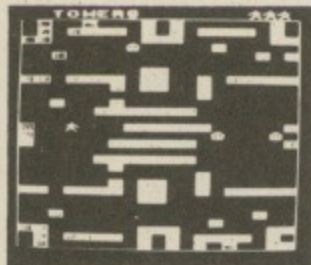

Turn off the lights and gather around for the most creepy game of the year. How you laughed at those superstitious fools in the village when they warned you not to go near the old house. The climb up the rocky path under the afternoon sun was swift and within an hour you had passed through the outer gates of this once great house. The dust and cobwebs hadn't bothered you as you climbed the old stairs to the towers on the top level. Did you notice how low the sun had fallen before the sounds of locks clicking reached your startled ears? How can the moon be out already and what's that moving towards you??? This all action game will have you ducking and diving from the GHOSTS and ZOMBIES, and matching wits with a MUMMY, WEREWOLF, and VAMPIRE. 5 floors full of odd CORRIDORS, BROKEN FLOORBOARDS, and riddled with SECRET PASSAGES await you. Superb sound effects and graphics. Can be played using either keyboard or joysticks. Top table. Pause option.

EARLY YEARS (B)(E) For children between 3-6 years of age. These two packages give an adult or older child a means to take a younger child through a series of simple game type tasks to enforce ideas. The emphasis is on learning through fun. Topics covered include subtraction, addition, recognition, colour, shapes, sizes, sounds/notes, co-ordination, distances, estimates, directions.

EARLY YEARS 1

- A) MICKEY THE MONKEY and his apple tree make subtraction fun.
- B) COLOUR BLOCKS bring sizes and colour into perspective.
- C) MERRY MUSIC turns the keyboard into a musical keyboard.
- D) FUNNY FACES presents a line up, which one is the suspect?
- E) FRED THE FROG needs co-ordinated help to get across the pond.

EARLY YEARS 2

- A) THE POND seems very active today
- B) SPEED is required to keep the cake on the conveyor belt.
- C) DIRECTIONS seem to be needed by everyone in Orion village.
- D) ORDER the blocks.
- E) SID THE SPIDER needs some help to get out of the maze.

Watch out for HOUSE OF HORRORS at local dealers.

Dealer enquiries welcome.
All prices are FULLY inclusive for UK orders.
Please add £1 per tape for non-UK addresses.
Cheques/P.O.'s should be made payable to
KAY-ESS Computer Products.
When ordering please state BBC or Electron.



Joystick Compatible

Available for:
(E) Electron (B) BBC Model B
FREE with all orders (Except H.O.H.)
our 3 level version of
NOUGHTS AND CROSSES!!!

ALSO AVAILABLE:

- STAR HAWKS (B) (E) - DESIGN (B) (E)
- HANGMAN (B) (E) - SPACE TRAFFIC CONTROLLER (B) (E) - HORSES (B) (E) - SPACE TANK (B)

KAY-ESS Computer Products,
11 Buttercup Close,
Romleighs Park,
Harold Wood,
Essex RM3 0XF.

ANSWER BACK SENIOR AND JUNIOR QUIZZES

GENERAL KNOWLEDGE

THE ULTIMATE CHALLENGE

BBC (32K)•ELECTRON



Juniors (Ages 6 to 11)

-defeat the mythical dragon and save the princess of KOSMOS Castle...

Seniors (Ages 12 and Over)

-pit your wits against the KOSMOS robot and destroy the Alien invaders...

But be warned, in your endeavours you will learn vast amounts of fascinating facts on an enormous variety of subjects. The ANSWER BACK quizzes provide an incredible adventure in education by allowing successful challengers to participate in the compelling games.

Each program comes complete with 15 enormous quizzes providing a total of 750 questions and 3000 optional answers. But that is only the start, you can also create and save an unlimited number of quizzes of your own design.

FEATURES INCLUDE

- Multiple choice answers
- True or False?
- Find the missing letters
- "Pass" facility
- Immediate correction of errors
- Timer option
- Performance summary
- Re-run of questions passed or incorrectly answered
- Full facilities for creating and saving an unlimited number of new quizzes

Available from your computer store or by mail order Price £10.95

Other educational titles include...
"The French Mistress"
"The German Master"
"The Spanish Tutor"

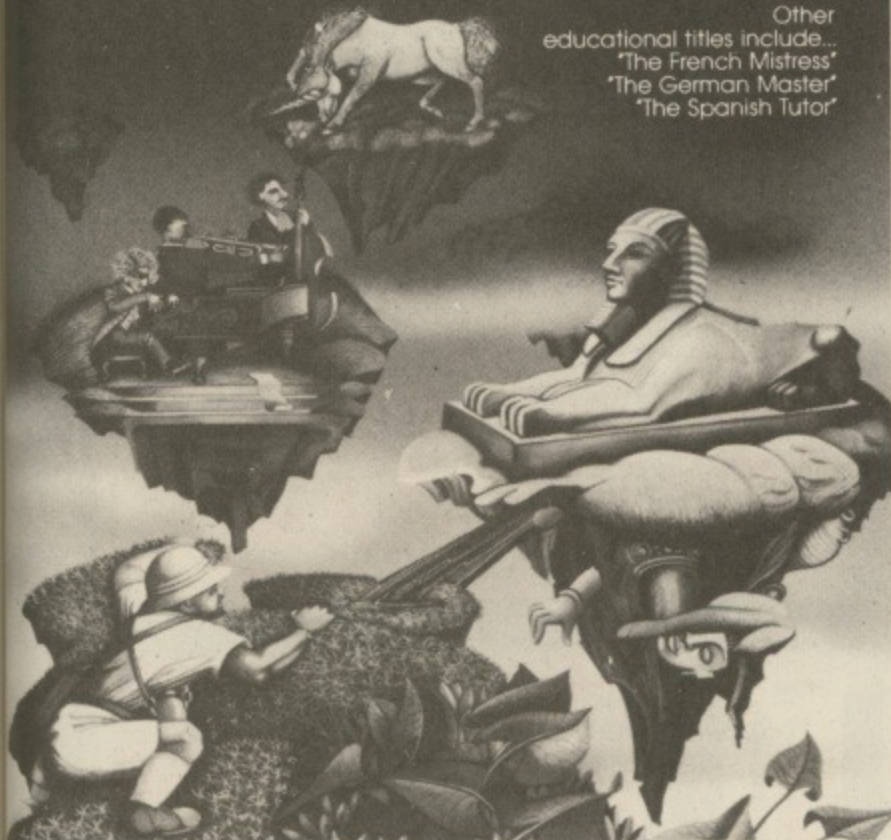

KOSMOS SOFTWARE LTD, 1 Pilgrim Close, Harlington, DUNSTABLE, Beds. LU5 6LX

Please supply the following programs for the BBC/ELECTRON computer
ANSWER BACK Junior Quiz @ £10.95
ANSWER BACK Senior Quiz @ £10.95

Mr/Mrs/Miss
Address
.....
..... Postcode

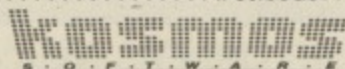

KOSMOS SOFTWARE LIMITED
1 Pilgrim Close, Harlington
DUNSTABLE, Beds. LU5 6LX
Tel. (05255) 3942

A selection of titles to ...

SOFTEN YOUR HARDWARE

MICRO ARTIST

(BBC B)

New Release

The best BBC program we have yet seen for versatile video artwork or screen design. 8 basic colours, 20 fixed commands including reflect, enlarge, rotate, letters, triangles, ellipses, fill, rubber bands, x & y coordinates, continuous or dotted lines etc. Plus 12 user defined characters instantly available for manipulation. The program requires a JOYSTICK which provides immediate on screen results using a unique expanding cursor to set size and position. Simple to use and capable of amazing results. Finished screens may be saved or printed. Straightforward instructions.

Remarkable value at

ONLY £7.50

MORSE TRANSLATOR

by G4MGD (BBC B)

New Release

Decoder/encoder; 6-22 wpm. Program requires an RTTY interface or a simple audio amplifier.

Translates morse signals received on a radio into plain language on the screen and allows messages typed in plain language on the screen to be transmitted in morse. (NOTE. It is an offence to transmit without the appropriate licence). RED keys

may be programmed for standard passages. £5.95

Also MORSE INSTRUCTOR by G4MGD (BBC B)

Teaches morse from single characters to 36 word passages. £5.95

SLIDER

(BBC B)

Synchronises a single slide film projector with a pre-recorded tape commentary or music background. A slide projector with remote control is required. Up to 999 slides may be controlled. Max clock time 99 hours, accurate to 1/10 second.

Applications for Lecturers, Photographers, Architects etc. Full instructions.

£8.50

SHIP LIGHTS GUIDE

(BBC B)

Teaches identification of sailing, powered and working vessels at night in conformity with the International Collision Regulations. £5.95

OTHER TITLES
Please send SAE for descriptions of our full list of current titles.

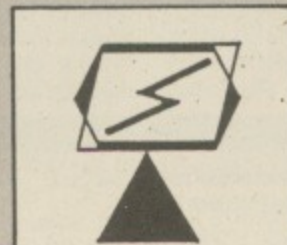

TO ORDER
Please send cheque/PO payable to PAEAN Systems. Orders are normally despatched within 24 hours of receipt by first class post. All prices are fully inclusive.

FOR **PAEAN** AND
BBC *systems* **ELK**

LITTLE BEALINGS, WOODBRIDGE,
SUFFOLK IP13 6LT
TEL: (0473) 623757

THE PRINTED WORD

LOW PRICES

TOP SERVICE

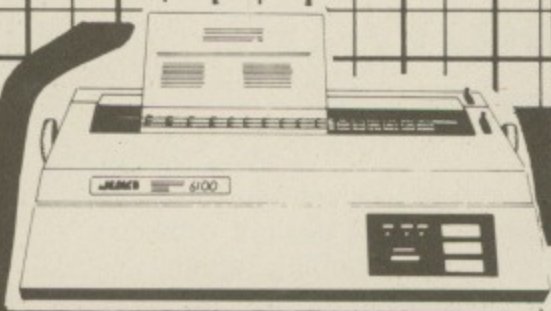

JUKI 6100

One Year Warranty
 20 CPS : BiDirectional & Logic Seeking
 10, 12, 15 & Proportional Spacing
 Wordstar Compatible
 2K Buffer : 13 Inch Platen
 Underline : Backspace + Lots more
 Centronics Interface Standard
 RS 232 Interface £54.00 + VAT Extra
 Tractor Feed £99.00 + VAT Extra
 Single Sheet Feeder £238.00 + VAT Extra

JUKI 6100 £330.43 + VAT = £380.00

BBC/ORIC or DRAGON Package
JUKI 6100 + CJE PRINTER PACKAGE
£400 Inc. VAT



CANON PW-1080A

Near letter Quality Printer

NLQ Mode 23 x 18 Matrix: 27 cps
 Draft Mode 11 x 9 Matrix : 160 cps
 Full range of Epson FX 80 Print Codes
 Friction & Tractor Feed
 Centronics Interface Standard
 CANON PW-1156A (Accepts 15" Paper) Available

CANON PW-1080A £278.26 + VAT = £320

CANON PW-1156A £360.00 + VAT = £414.00

PACKAGE PRICE for BBC MICRO/DRAGON/ORIC
CANON PW-1080A C.J.E. PRINTER PACKAGE £345 Inc. VAT
CANON PW-1156A C.J.E. PRINTER PACKAGE £439 Inc. VAT

Special RS 232 Printer Bargain

STAR DP8480 (8" Printing) £187.00 Inc VAT
 Ideal for BBC/Newbrain/HX20 & Spectrum Int. 1
 Phone for full specification

C.J.E. Micro's BBC Printer Packs
 For Star, Canon & Juki Printers include:

1. The Printer
2. Delivery by Securicor
3. Cable to the BBC 1.3 Metres
4. Screen Dump Program (M/C Source)
5. Text Dump Program
6. Function Key set up Program. For use with WORDWISE
7. Function Key Label Printing Program. For use with above.
8. VIEW Printer Driver
9. 100 Sheets of Paper
10. Mains Plug with 3 Amp Fuse
11. Booklet giving details of using the printer with a BBC.
12. Character Defining Program for Downloadable-character-set
 C.J.E. Printer Packs for other micro's include:-
 Printer, Cable, Paper, Mains Plug & Delivery

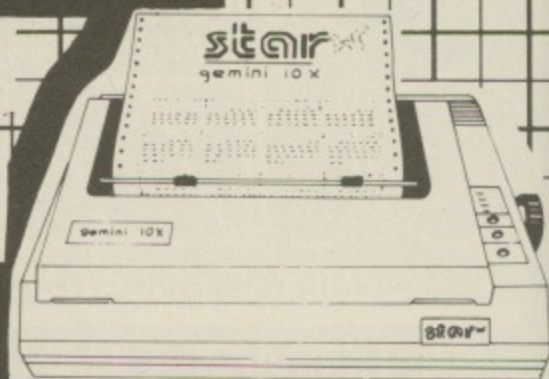

STAR GEMINI 10X

One Year Warranty
 True Descenders 9 x 9 Matrix
 120 CPS Bidirectional & Logic Seeking
 40, 48, 68, 80, 96, 136 cpl
 Italics, Emphasized, Double strike,
 Super & Sub Scripts
 Downloadable Character Set
 Hi-Resolution & Block Graphics
 Friction or Tractor Feed
 10 X 10" Carriage, 15 X 15" Carriage
 Centronics Interface Standard
 RS232 Int. £52.00 + VAT Extra

Gemini 10X £235.00 Inc VAT
Package for BBC/DRAGON/ORIC
GEMINI 10X + CJE Printer Pack £255 Inc. VAT
Star Gemini 15X £380 Inc. VAT

STAR DELTA 10
SPEC. AS FOR 10X PLUS:-
160CPS: 8K BUFFER
CENTRONICS + RS232 INT'S STD
£311.30 + VAT = £358.00

BBC MICROMODEL B £399.00 Electron £199.00

BBC Micro Model B with Disc Int. £469.00

Large Range of Accessories including Disc
 Drives, Printers, Monitors always in stock.

Printer Cables

BBC to 36 Way Centronics Type Connector £15.00
 Dragon to 36 Way Centronics Type Connector £15.00
 Oric to 36 Way Centronics Type Connector £15.00
 Torch to 36 Way Centronics Type Connector £20.00

Serial Printer Cables

BBC to 25 way D type £9.50
 EPSON HX20 to 25 way D type £9.50
 NEWBRAIN to 25 Way D Type £12.00
 25 way D type to 25 way D type £15.00

Blank C15/C30 Cassettes Ten for £4.50 ANY MIX
 Send SAE for Full Price List

VAT INCLUDED WHERE APPLICABLE PHONE/CREDIT CARD ORDERS WELCOME

Postage 50p per order or as stated
 24 Hr Securicor Delivery
 for Printers/Disk Drives £8.00
 (SHOP/WORKSHOP CLOSED MONDAYS)

C.J.E. Microcomputers

Dept (MU), 78 Brighton Road, Worthing
 W. Sussex BN11 2EN (0903) 213900

EXPORT ORDERS WELCOME

RING FOR SAMPLE PRINTOUT, FULL SPECIFICATIONS & LATEST PRICES
BEST PRICES & BACKUP ON THE STAR JUKI & CANON PRINTERS

L You really can't go wrong with any Level 9 game as they are really brilliant



CRASH MICRO SEPT '84.

✓ Whichever machine you own, if you have the vaguest tendency towards adventure playing then you must try one of these games (unfortunately you'll probably end up wanting to buy the lot!).
Computing Today, August 84

✓ To me, all Level 9 adventures create a remarkable atmosphere because the descriptions sound so life-like. This is where so many other adventures fail.
Crash, July 84

✓ But it's not just the size of the game it's the quality as well that is astonishing ... scenes to fire the imagination.
PCG, April 84

✓ As in all Level 9's adventures, the real pleasure comes not from scoring points but in exploring the world in which the game is set and learning about its denizens.
Which Micro?, February 84

✓ (LORDS OF TIME). As we have come to expect from Level 9, the program is executed with wonderful style ... Highly recommended.
PCW, 1 February 84

✓ I thoroughly recommend these Adventures they are excellent value for money. No self-respecting Adventure-addict should be without them. I believe Level 9 are producing a series of Adventures which should be regarded as classics.
Atari User,

✓ These programs run very fast and there are no frustrating pauses. Level 9 Adventures are superbly designed and programmed, the contents first rate. The implementation of Colossal Adventure is nothing short of brilliance; rush out and buy it. While you're at it, buy their others too. Simply smashing!
Your 64, June 84

✓ Level 9 - arguably the producer of the best adventure games in the UK - has done it again. LORDS OF TIME is a sparkling addition to its stable of winners.
Acorn User, July 84

✓ (SNOWBALL). This is another imaginative, massive-scaled immensely enjoyable adventure from those experts down at Level 9
Your Computer, March 84

Owners of cassette games can upgrade to disk. Send your cassette to us with £2.50 to cover costs.

Return to Eden



Level 9 Computing

Level 9's epic adventures are now here for the AMSTRAD. Disk versions are available for the BBC (40/80 track) and Commodore 64. And, best of all, RETURN TO EDEN is ready. It's been a busy month!

RETURN TO EDEN is the long-awaited sequel to

NEW

Level 9's top-selling Snowball adventure. Now it's here with 220

locations, masses of puzzles, and with pictures on the CBM and Spectrum versions.



Cassette £9.95 Disk £11.95

I ENCLOSE A CHEQUE/PO FOR £9.95 EACH (CASSETTE) OR £11.95 EACH (DISK) FOR BBC OR CBM 64

- 1. **COLOSSAL ADVENTURE.** The classic mainframe game with 70 bonus rooms.
- 2. **ADVENTURE QUEST.** An epic journey through Middle Earth.
- 3. **DUNGEON ADVENTURE.** A massive game which completes the Middle Earth Trilogy.
- 4. **SNOWBALL.** Save the interstar freezer, Snowball 9, in a huge space adventure with over 7000 locations.
- 5. **RETURN TO EDEN.** SF adventure on the weirdest planet ever. The sequel to Snowball, though you don't need to have played this.
- 6. **LORDS OF TIME.** A humorous romp through World History.

My name:

My address:

My micro is a:

(one of those listed below, with at least 32K of memory).

Contact:

LEVEL 9 COMPUTING

Dept. U, 229, Hughenden Road, High Wycombe, Bucks. HP13 5PG.

Available from W H Smith and good computer shops everywhere. If your local dealer doesn't stock Level 9 adventures yet, get him to contact us or: Centresoft, Microdealer UK, Ferranti & Craig, Leisuresoft, Lime Tree, LVL, PCS, R & R or Wonderbridge.

AMSTRAD BBC CBM64 SPECTRUM MTX ORIC 1 LYNX NASCOM ATARI

M I C R O P O W E R M I C R O P O W E R M

ANOTHER INCREDIBLE CHALLENGE FROM BRITAIN'S LEADING SOFTWARE HOUSE

FELIX

Meets
The

EVIL WEEVILS



Clamber up the pipes, dodging the cascading ball bearings to despatch the Weevils and Superweevils using your spray can. Features oxygen cylinders, bonus letters, belt lever and panic button.

NEW PRICE! B.B.C. and Electron cassette: £6.95.
B.B.C. disk version: £9.95.

(Also Micro Version)

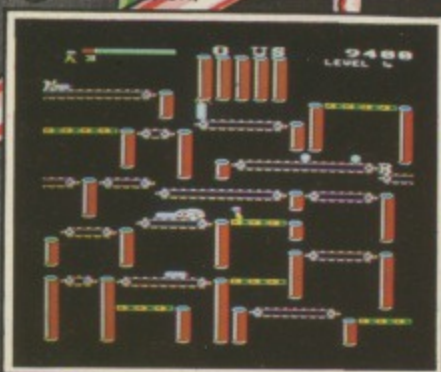

electron
B.B.C. MICRO

M I C R O
P O W E R

"WATCH OUT FOR THE FANTASTIC NEW PACKAGING!!"

MICRO POWER LTD.,
NORTHWOOD HOUSE, NORTH STREET,
LEEDS LS7 2AA TEL: (0532) 458800
MICRO POWER SOFTWARE IS AVAILABLE FROM
SELECTED BRANCHES OF WH SMITH, BOOTS, JOHN
MENZIES, CO-OP, WOOLWORTHS AND ALL GOOD
DEALERS.
AUTHORS! WE PAY 20% ROYALTIES!



M I C R O P O W E R M I C R O P O W E R M

Do you want to expand your mind

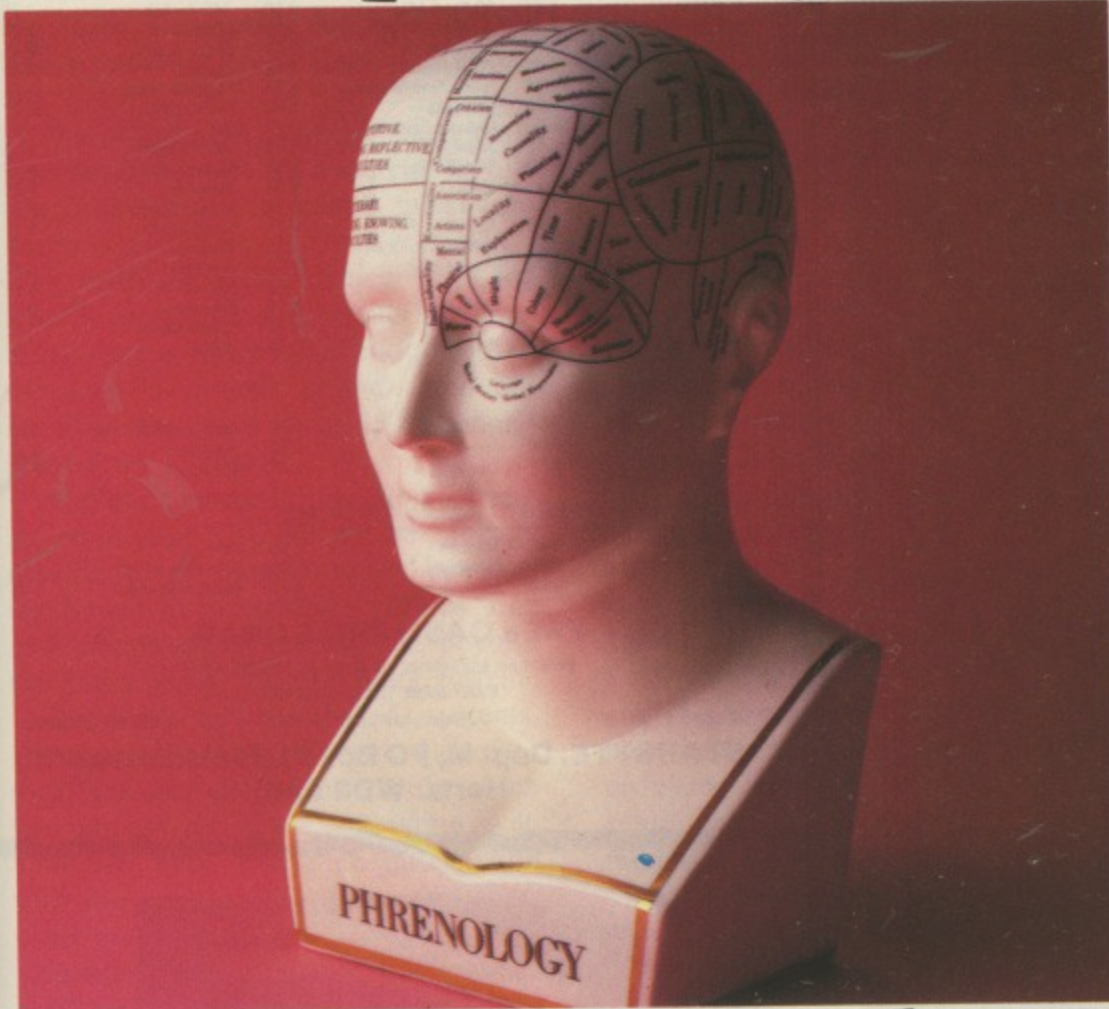

or lose weight?



Home computing isn't all fun and games. The Mirrorsoft Home Discovery series of software programs can help broaden your knowledge and experience or even assist you to lose weight.

KNOW YOUR OWN PSI-Q

How strong are your Psi powers? This intriguing and comprehensive package, by Prof Hans Eysenck and Carl Sargent is based on their book published by Michael Joseph. It checks for and helps develop latent Psi ability in individuals or groups of individuals – notably clairvoyance, recognition of hidden objects or symbols, and precognition, foretelling future events.

On cassette for the CBM64, Spectrum 48K, BBC B, Electron. **£9.95**

KNOW YOUR OWN PERSONALITY

A fascinating way to get through to the 'real' you. Devised by Prof Hans Eysenck and Dr. Glenn Wilson from their Pelican book of the same name. You'll get a clearer insight into yourself, and others too.

On cassette for the Spectrum 48K, BBC B, Electron. **£9.95**

STAR SEEKER

Published in association with the London Planetarium. This pair of programs, written by Dr. Paul Phillips FRAS, brings the magic of the heavens into your home.

Star Seeker accurately plots the most prominent stars from any position on Earth; at any time in this or the next century. You can obtain information on individual stars, and draw constellations. Solar System plots Planets and Halley's Comet, with us next year!

On cassette for the BBC B (Spectrum 48K and CBM64 versions coming soon). **£9.95**



MASTERMIND

Adapted from the well known BBC TV quiz game, this program lets you take the chair for general knowledge and special subject questions. It comes with two sets of each. Up to four players. Further low-cost packs of questions coming soon.

On cassette for the Spectrum 48K, BBC B, Electron. **£9.95**

THE JOFFE PLAN

A 'no-diet' personal weight control program. Prof. Joffe's Plan awards credits or penalties based on progress to a target weight agreed between the user and the computer. Food is the best reward for an over-eater. So credits earned allow you to indulge a favourite dish. Penalties mean less food, more exercise.

On cassette for the CBM64, Spectrum 48K, BBC B, Electron. **£9.95**

Also available: Mastermind QUIZMASTER – Set your own questions to run on the Mastermind program. On cassette for the Spectrum 48K, BBC B, Electron. **£5.95**



MIRRORSOFT
SOFTWARE FOR ALL THE FAMILY

Available from Boots, W. H. Smith, Spectrum and all good software stockists. Write for free catalogue to: Mirrorsoft, Holborn Circus, London, EC1P 1DQ.

**AT
PL****TURN
YOU****INSIDE****WITH THEIR
SIDEWAYS ROM
EXTENSION
SOCKET**

INSIDEOUT is designed to make a sideways ROM socket available outside the BBC computer, to allow for easy exchange of sideways ROM's.

CAN BE USED FROM BBC MODEL B OR EXPANSION BOARD SOCKETS

SUPPLIED WITH LOW INSERTION FORCE SOCKET FOR EASE OF USE

NO COSTLY CARTRIDGE PACKING

EPROM PLUG IN AND GO

NOT LIMITED TO ONE DEVICE

SOCKET RATED AT 100'S OF INSERTIONS

MOUNTED OUTSIDE THE BBC, EASILY REMOVED AND REFITTED

CAN BE MOUNTED IN USER DEFINED LOCATION — NOT FITTING IN AN ILLEGAL POSITION

ONLY**£13.00**

+ VAT

p+p 50p

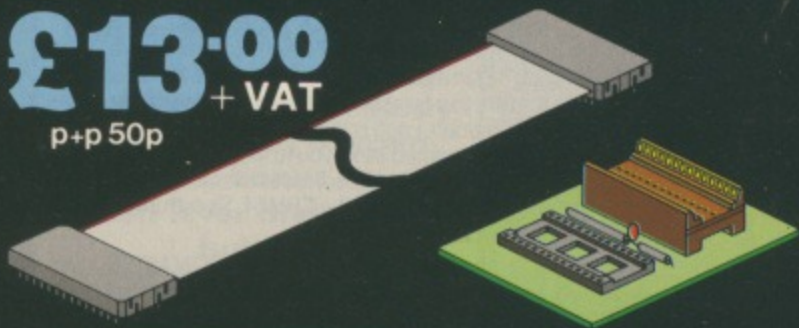
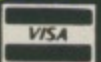
**AT
PL****Advanced
Technology
Products
Limited**Station Road, Clowne,
Chesterfield,
Derbyshire S43 4AB
Telephone:**(0246) 811585 (4 lines)**ACCESS AND BARCLAYCARD accepted.
50p Carriage to be added to advertised price, then add VAT**CONDITIONS OF SALE & DELIVERY**

Cheques made payable to Advanced Technology Products Ltd., please allow 28 days for delivery. Quantity orders and overseas carriage charged at cost. Conditions of sale available on request.

DEALER ENQUIRIES WELCOME**STARBYTE**

These Special Introductory prices are available only to readers of The Micro User.

BBC 'B' TOP 20

Frak	7.80	Mr. Wiz	6.85	Twin Kingdom Valley	7.98
Overdrive	6.60	The Mine	6.60	Mined Out	6.10
Fortress	7.49	Dune Rider	6.60	Spooks & Spiders	6.60
Stock Car	6.60	Hobbit	11.89	Eagles wing	6.60
Aviator	11.89	JCB Digger	8.41	Star Striker	6.80
Hulk	8.20	Dare Devil Dennis	6.50	Snowball	6.70
Blogger	7.10	Cylon Attack	6.60		

QUICK FIND ALPHABETICAL LIST

1984	5.90	3D Bomb Alley	6.50	747-Dr. Soft	7.75
Adventure Quest	8.70	Arcadians	8.30	Beebtrek	3.97
Castle of Riddles	8.30	Centipede	6.90	Chess (Acorn)	8.45
Chuckie Egg	6.60	Classic Advent	6.25	Drogna	8.30
Felix in Factly	6.60	Felix & Fruit Monsters	6.60	Franklins Tomb	8.05
Freefall	8.30	Galaxians	6.60	Gate Crasher	5.90
Ghouls	6.60	Gisburns Castle	7.29	Gorf	6.89
Hell Driver	6.60	Jetpac	6.90	Jnr Wordsplits	8.30
Johnny Reb	6.20	Killer Gorilla	6.60	Lords of Time	8.70
Lost in Space	8.40	Meteors	8.20	Monsters	8.30
Mr T. Series	11.75	Mr Wimpey	5.99	Music Processr	12.25
No. Skills 5-7	8.75	No. Skills 7-8	8.75	Number Rally	8.75
Owzat	6.99	Philosophers Quest	8.30	Pimania	8.70
Planetoids	8.30	Pole Position	13.75	Pyramid of Doom	6.90
Rocket Raid	8.30	Snooker	7.35	Spitfire	6.90
System 15000	10.25	Tanks	6.90	The Count	6.90
Time Traveller	8.39	Tool Box	16.75	Voodoo Castle	6.90
White Knight 2	9.35	Wordpower	8.39	Zalaga	7.50

ELECTRON

Killer Gorilla	6.60	Hunchback	5.75	Twin Kingdom Valley	7.97
Cylon Attack	6.60	Blogger	6.80	Meteors	8.35
Dare Devil Dennis	6.55	Snooker	7.70	The Hulk	6.90

*****SPECIAL OFFERS*** - while stocks last**

Laser Command	2.89	Timetrek	2.89	Zarm	2.89
Asteroid Storm	2.89	Hell Driver	2.89	Alien Swarm	2.40
Demon Dec'tor	2.40	Space Jailer	2.40	Caveman Advent	2.40

FREE CASH PRIZE DRAW

Order now and receive our fantastic savings offer

MANY MORE TITLES AVAILABLE

Cheque/P.O. to:

Please state which micro.

SAE for full details.

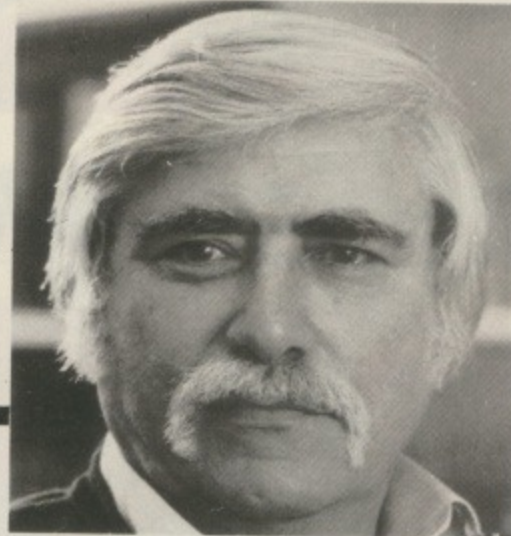
**STARBYTE, Dept M, PO Box 91, Rickmansworth,
Herts. WD3 6JB.****Harold Rules..OK?**

When you call please don't disturb Harold — he broke 1000 on Snapper last week and hopes to crack 2000 soon. Mind you, there are other machines in the store that you can use to try out the software from our extensive range. Printers, disc drives and monitors too.

6 Chatterton Road, Bromley, Kent.
460 8991**Data Store**

WIN

this ROM based database from Gemini

Great FREE contest!

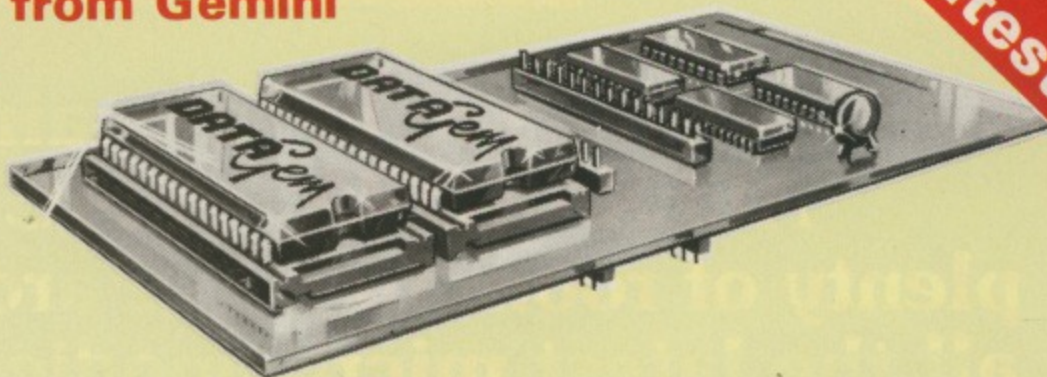

PRIZES for this month's competition are three Datagems, the new ROM-based database from Gemini Marketing.

The 24k random access management system is housed in a carrier board which is simple to install inside the micro – switch on and you're away!

A database is a technical term for what is essentially a computerised card index system. Any application suitable for such a system – and there are literally thousands – could be implemented on Datagem.

And because the information is being stored in your BBC Micro, the package uses its tremendous speed and computing power to incorporate various time and labour-saving facilities far beyond the limits of any manual filing system.

Designed for disc-based systems, Datagem allows you to create files of up to 5,100 user definable records which you can extend, delete, and edit at will. You can even exchange information with the popular Wordwise and View word processors.

In addition, Datagem can be used to produce standard but personalised letters to large groups of people meeting specific requirements. Further options are contained within the software for

searching, sorting and printing.

As you can see the potential is quite enormous. So why not try and win one for yourself?

The competition is not difficult – all you need is a sense of humour – and we know from experience that our readers have plenty of that!

The photograph you see below was taken from a local news item at the time of the Manchester Electron and BBC Micro User Show in September.

The story accompanying the photograph told of the Bibby twins, Mike and Pete, features editors of *The Micro User* and *Electron User* respectively, and how their identical appearances caused problems for everyone they met. (The real cause of these problems must remain a closely guarded secret.)

To celebrate the arrival of the show it was decided that one of them must remove his hirsute appendage. Mike, as courageous as ever, did what you would expect any man to do in his position: he chickened out at the last minute.

It took four of us to hold him down

while Barry Wood did the dirty deed. He was then, and is now, as clean shaven as the day he was born.

He certainly looks happy enough in the photograph, and we're sure that at the time he was telling Pete how much he enjoyed his new looks.

Perhaps you know better? All you have to do is supply the conversation by inserting the missing words in the bubbles – the most amusing and imaginative entries win.

No more than 20 words from each twin please, and keep them printable – the lads are renowned for their delicacy...

WINNERS of the competition in the August *Micro User* were R. Hersee, Tallington, Lincs; P. Geertsen, Horsholm, Denmark; and R.L. Godfrey, Godalming, Surrey. Their Ultra-drives are on the way to them.

Your FREE entry form

How to enter:

Fill in the speech bubbles (not more than 20 words in each) Then send your completed entry form to:

**Speech Bubble Competition,
The Micro User, Europa House,
68 Chester Road, Hazel Grove,
Stockport SK7 5NY.**

Name _____

Address _____

Entries must reach us no later than
November 30, 1984.



Organised by
The Micro User
and Electron User

Come to our great prCh

Yes, we're back again at the spacious
ALEXANDRA PALACE - where there's
plenty of room to move around and inspect
all the latest micro goodies at your leisure!

**Look what
you can
see . . .
try . . .
and buy!**

BBC Micros Electrons

Teletext adapters
Torch disc packs
BBC Buggies
Second
Processors
Mouses
ROM Expansion
Boards
Grafpads
Books
Joysticks
Interfaces
Disc drives
Data recorders
Lightpens
Modems
Speech
Synthesisers
Carrying Cases
Cables
Digitizers
VDU stands
Graphics tablets
ROM chips
Monitors
Printers

Everyone who is anyone in the exciting world of the BBC Micro and Electron will be at our greatest ever autumn show. And that includes all the big names you see advertising in the pages of our magazines.

Waiting for you will be more than 150 stands, packed with hardware, software and peripherals - some on show for the first time.

And everything will be for sale - much at really low, show prices!

Once again our team of writers will be there to give you free advice - an ideal opportunity to find out all the facts on the latest computing techniques. Don't miss this chance to meet in person the names you see in these pages every month!

Free buses!

To get you to the show as easily as possible we are running free Show Buses from Alexandra Palace station, leaving every 10 minutes.

Free parking!

There's plenty of free parking, too. All part of the service to make this an enjoyable and relaxing computer day out!

OPENING HOURS

10am-5pm	Thursday, 25 October
10am-5pm	Friday, 26 October
10am-5pm	Saturday, 27 October
10am-4pm	Sunday, 28 October



Christmas bonanza!

Thursday to Sunday
October 25 to 28

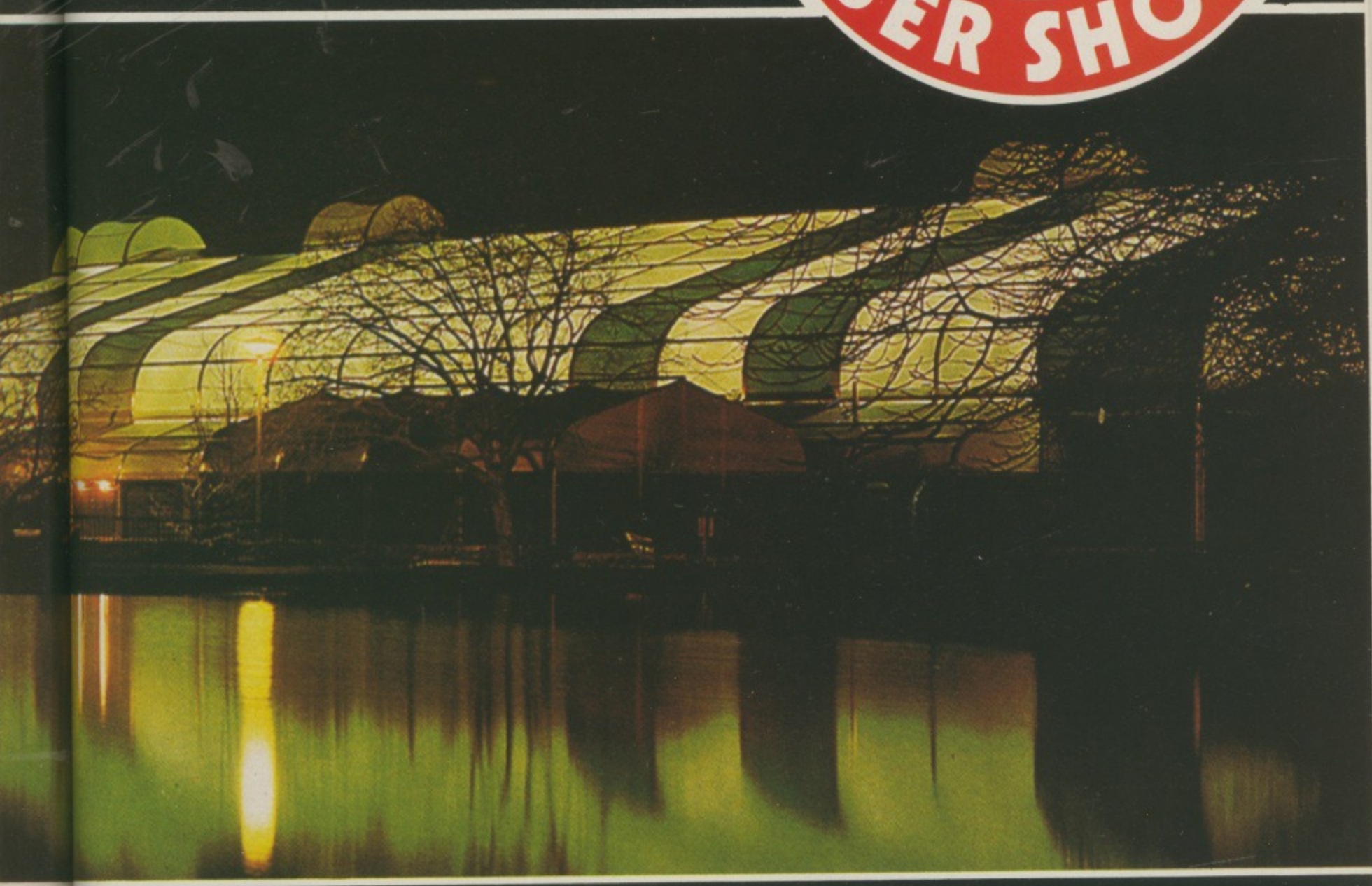

This voucher is worth £1 per head

Reduced prices for School/College Groups

Entry only £1 per student if bookings are made in advance. Send your cheque (made payable to Database Publications) and SAE to:

Electron & BBC Micro User Show
68 Chester Road, Hazel Grove,
Stockport SK7 5NY
Tel: 061-456 8383
Valid for a minimum of 10 people

SAVE MONEY with our Special Travel and Hotel Offer

Visitors to the Show can obtain cut-price rail tickets from ANY station in the United Kingdom - plus special reduced prices at London hotels. Write to:

Travel Offer, P.O. Box 1, St. Albans AL1 4ED with SAE or Telephone: St Albans 34475 quoting: The Electron & BBC Micro User Show.



By handing in this voucher at the door you save £1 off the normal admission price of £3 (adults) and £2 (children).

(Valid for a maximum of 4 people)

- 10am-5pm, Thursday, 25 October
- 10am-5pm, Friday, 26 October
- 10am-5pm, Saturday, 27 October
- 10am-4pm, Sunday, 28 October

**Alexandra Palace
Wood Green, London N22.**

Number attending: 1 2 3 4

SERIOUS SOFTWARE

FOR THE B.B.C. MICRO AND ELECTRON

From BEEBUGSOFT

MASTERFILE

MASTERFILE is a general purpose data base, written especially for the BBC Micro. It is extremely useful, allowing vast amounts of information to be quickly stored.

Once set up, the information may be retrieved or sorted at any time, in a number of different ways, using any of the fields as keys.

Records may be instantly displayed or printed, using any printer suitable for the BBC Micro, also a label printing facility is included.

Separate versions of the program are available for cassette and disc based systems. The disc version uses random access files to maximise record storage.

One extra feature of the disc version is that it provides limited spreadsheet facilities.

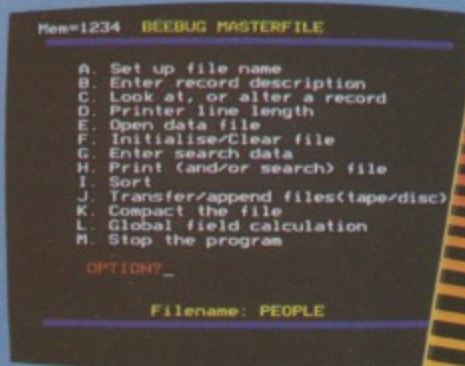

"... Works well and offers an efficient data base..."

PCN NOVEMBER 1984

SPELLCHECK

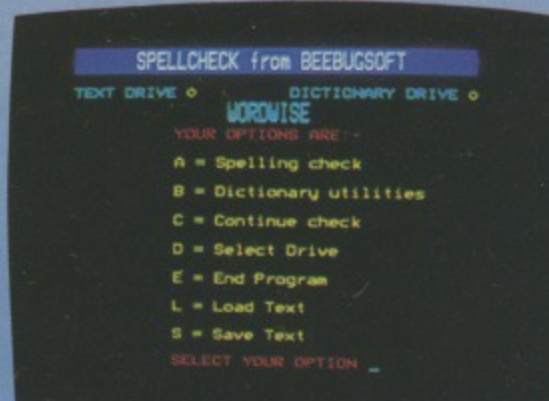

SPELLCHECK is menu driven, and is the ideal companion for WORDWISE or VIEW. It provides an automatic spelling check for letters or documents.

It is supplied with a dictionary disc already containing 6000 words, which may be increased to a maximum of about

17,000 words on a 100K disc.

Random access files ensure very fast word retrieval from the dictionary disc.

SPELLCHECK is menu driven, and is very simple to use, allowing unknown words to be added to the dictionary, ignored or re-spelt.

Incorrectly spelt words may be instantly respelt and a correct version of the document filed away, ready for printing or later use.

Dictionary discs for foreign languages may easily be created to help check letters sent abroad.

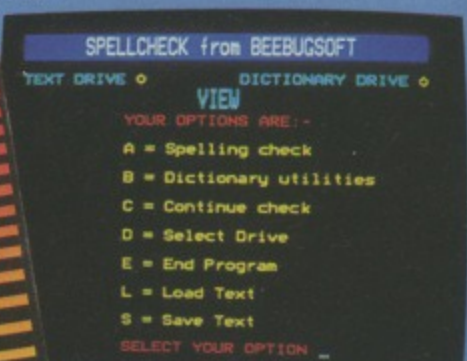

"... I found the program to be invaluable... fast and reliable... a worthwhile investment."

PCN FEBRUARY 1984

BEEBUG SOFT

MASTERFILE £19 (DISC) £10 (CASSETTE)

SPELLCHECK £19 (DISC)

AVAILABLE FROM YOUR LOCAL DEALER & SELECTED BRANCHES OF W.H. SMITH  Prices include VAT



ACCESS ORDERS & ENQUIRIES: TEL ST. ALBANS (0727) 60263

MAIL ORDER (POST FREE) TO: BEEBUGSOFT, Mailing Dept 16 P.O. Box 109 High Wycombe Bucks

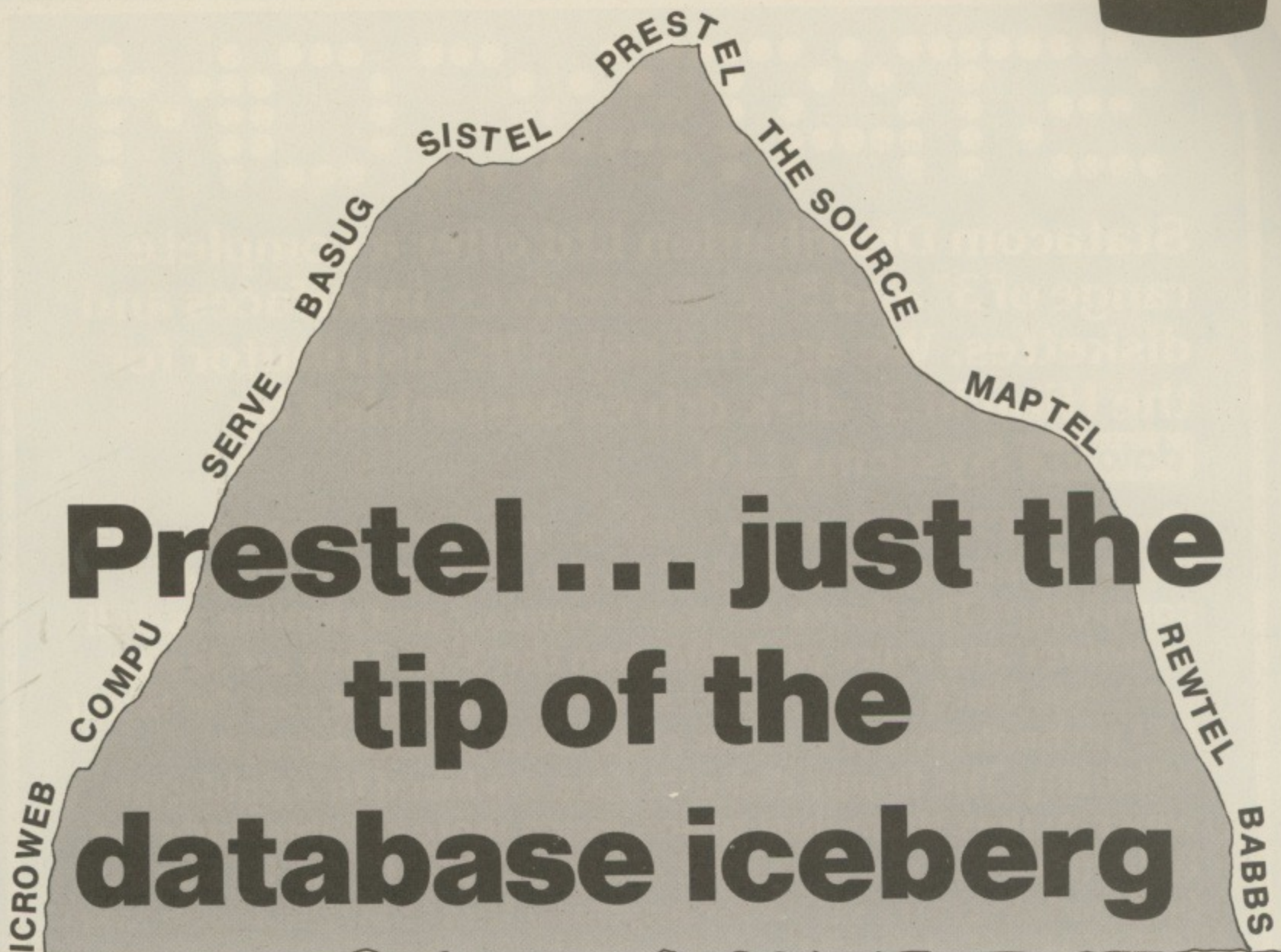

Prestel... just the tip of the database iceberg

IN my last article I looked at the development and future of Prestel. Now we'll take a look at what else is available to computer users who have access to a phone and a modem.

In order to understand how databases work, it is helpful to understand a bit about how the data is transmitted down the phone lines, possibly from a distant computer to your own, or vice versa.

Basically each character is allocated a number, usually the Ascii code, which I'm sure most readers will be familiar with. This number is then transmitted as a series of pulses of different frequencies down the phone line, the resultant string of pulses then being reconstructed at the other end into a screen or teletype display.

The variable factors in such transmissions are the speed of the pulses and the actual frequencies used. The speed is measured in the number of characters per second – baud rate – and the frequencies used to conform to international guidelines.

In the UK most bulletin boards operate at the almost universal transmission frequencies of CCITT. In normal usage such nuances of the system need not bother the reader. The more crucial factor is the speed of

By STEVE GOLD

transmission, which for bulletin boards is usually 300 baud send and receive – roughly 30 characters per second.

However, mainly due to the widespread use of Prestel, the rate of 1200 baud receive (at your terminal) and 75 baud transmit is gaining acceptance.

If the reader's modem and computer can receive Prestel then it's a safe bet that it is operating at 1200/75 baud. However all is not lost, for many modems are capable of dual or more frequencies, like the Nightingale modem being offered by *The Micro User*.

A bulletin board is simply what it says – a board where people can dial in and read or write notes to each other. It acts as a central point where networkers can "chat" to each other via their keyboards.

In the past few years there has been a profusion of bulletin boards in the UK including, of course, the introduction of Microweb. At the end of this article there is a list of boards available to UK modem owners. Please note, however, that some boards operate only restricted hours, so read the notes carefully.

If one looks at the USA, where, for various reasons, the idea of bulletin boards started, you can see the evolution of networking several years ahead of the UK.

Most boards within the UK involve people in a long distance call costing between £3 and £4 an hour. Call charges in the States, because of the vast distances involved, are proportionally greater.

In the early 1970s, certain US networkers were forced to look at the alternatives to that provided by Ma Bell, the US equivalent of British Telecom.

There exists in this country, as well as most others, including the US, an overlay network which serves exclusively to shift data between computers. Such systems are called packet switch networks, because they packet data up and whiz it between exchanges, or nodes as they are called.

Since the data is packeted, it can share the same lines as other data packets, with resultant savings in line costs. These reductions result in substantial economies to end users when compared to the public telephone networks.

Most large users of packet switch

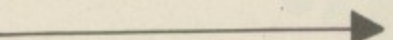

Statacom Distribution Ltd offer a complete range of 3" and 5 1/4" disk drives, interfaces and diskettes. We are the sole UK distributor for the Hitachi 3" disk drives assembled by **datafax Systems Ltd.**

The HITACHI 3" disk drive unit is now firmly established and is fast displacing the old 5 1/4" as the standard for home computers. The drives are more compact and slimline as well as lighter and more portable than the 5 1/4". They are faster (average track to track access time: 3ms.) and use the latest LSI technology, for a lower chip count and improved reliability. The floppy diskettes are enclosed in a rigid case which makes them dust proof, much more reliable and easy to handle. The diskettes are also flippable, ie can be used on both sides! Don't settle for anything less than the legendary HITACHI reliability.

All drives supplied cased in a sleek metal casing, and complete with leads, cables and a utility disk. Each drive is tested and is covered by a full one year warranty.

PRICES INCLUDE VAT.

ONE SINGLE SIDED 100K	£167
ONE DOUBLE SIDED 200K	£199
DUAL SINGLE SIDED 200K	£334
DUAL DOUBLE SIDED 400K	£437

NB: Optional internal power supply unit available for £35 extra

GENEROUS DEALER DISCOUNTS:

For full price list please contact:

**STATACOM
DISTRIBUTION LTD.**

18 GROVE ROAD
SUTTON, SURREY
Telephone 01-661 2266

Name

Address

Tel.

(For dealer enquiries information please attach letterhead)

- Please tick requirements:
- Full Brochure Pack
 - Dealer Information
 - 3" Tech Details
 - Interface Details

From Page 151

networks are hooked directly in via datalines, but smaller users can dial in to nodes – usually at local call rates – and transmit via their modems to these distant mainframes.

In this way a user in New York can make a local phone call to his local packet switch node and contact a computer in California at a cost of only pence per minute.

It doesn't stop there. A call via Packet Switch Stream – the UK's packet switch network – costs as little as 13p a minute to link with a mainframe in the States. This compares favourably with a charge of about £1 a minute direct dialled transatlantic phone call.

Back to the States. In the early 1970s, certain large companies realised the potential of PSS. If they reduced the network costs to end users they could add on a service charge and provide a sophisticated service in addition to a basic bulletin board.

Such a service would be many times the size of a normal bulletin board and

'A user in New York can contact California at a cost of only pence per minute'

contain megabytes of information on most imaginable (and unimaginable) networking and associated subjects.

So it was that the concepts behind The Source and Compuserve were born.

The Source provides, in essence, an American parallel of the UK's Prestel

database, but on a much larger scale, both in services provided and the numbers catered for. Since it is much older than its UK cousin network, its services are some three to four years ahead of the UK's in evolutionary terms.

Notable facilities include interactive noticeboards, electronic mail (with links to other services), teleconferencing, telemessaging and participative file areas for all users.

Compuserve is younger than The Source and this is reflected in its service, which is comparatively more user friendly and more fun to use. I suppose one could say that Compuserve's general policy is much looser than that of The Source, which is owned by the Readers Digest.

Its services, not surprisingly, are the mirror image of those on The Source, with one of two enhancements. For example the interactivity between members is enhanced by the use of the Citizens Band simulator which, as the name implies, is a realtime interactive CB allowing chatting via the keyboards of the various computers online at any given time.

Both The Source and Compuserve can be accessed via direct dial as well as PSS from this country, and while being more expensive than Prestel – which is, after all, a cousin of these US based systems – are great fun to use as well as being very informative.

The average reader of this article will, by now, have deduced that there is a whole lot more to networking than Prestel alone. Indeed, Prestel is but the tip of the iceberg as databases go. There are many other services and databases available via PSS to end users, but, sadly due to their business orientation, their charges are correspondingly higher.

The author produces a monthly cassette-based magazine which takes up the networking story where this article leaves off. It costs £2, which includes a C90, and is currently available for BBC and Sinclair Spectrum owners.*

Other points of contact:

Compuserve Information Services, 5000 Arlington Centre Blvd, Columbus, Ohio 43220.

Tel: 01 01 614 457 8650.

Source Teleputing Facility, 1616 Anderson Road, McLean, Virginia, 22102.

Tel: 01 01 703 821 6666 734 7500.

Packet Switch Stream (National Networks), London.

Tel: 01-920 0661 or Freefone 2170.

*Further details from Steve Gold, 9 Watt Lane, Sheffield 10 or Prestel Mailbox 019995800.

UK BULLETIN BOARDS

Name	Tel. No.	Baud Rate	Hours of operation
Basug	0268 778953	300+ 1200/75	24 hours
BABBS	0742 667983	300	24 hours
Birmingham	0827 288810	300	24 hours
Blandford	0258 54494	300	24 hours
CBBS NE	07073 28723	300	6.30-10.30pm
Computer Answers	01-631 3076	300+ 1200/75	24 hours
Distel	01-679 1888	300	24 hours
Hull Forum 80	0482 859169	300	5.30-11.30pm (M-F). Noon-11.30pm (Sa and Su)
Liverpool	051-428 8984	300	24 hours
London CBBS	01-399 2136	300	5-10pm (Sun)
London TBBS	01-348 9400	300	10pm-1am (M-F). 2pm-1am (Sa and Su)
Manchester	061-427 3711	300	10.30-12 midnight (Sun-Thurs). 10.30-2am (F and Sa)
Maptel	0702 552941	300	24 hours
Microweb	061-456 4157	300	24 hours
Nottingham	0602 289783	1200/75	24 hours
Rewtel	0227 232628	300	24 hours
Southern BBS	0243 511 077	300	24 hours
Stoke Itec	0728 265078	300	24 hours
Surrey BBS	04862 25174	300	24 hours
South West	0626 890014	300+ 1200/75	24 hours
TBBS Southern	0703 437200	300	Evenings (ring back)
Wembley Forum 80	01-902 2546	300	Evenings and weekends
West Midlands	0384 635336	300	5.30-8.30am

Several of these have up-to-date listings of currently active boards.

All aboard for the data package tour

By MIKE COOK

WHENEVER information is moved from one place to another over channels that can carry more than just one voice, it travels in packets. Just like the low cost package tours that pack many holiday makers onto one aeroplane for economy, data is bundled into many packages and sent along one channel.

A voice signal is packaged in the same way for long distance and overseas phone calls and at the other end it is unwrapped and given its own channel.

All this is done to utilise the capacity of a channel economically. This capacity is known as its bandwidth and it is a measure of how many signal transitions can be transmitted in a second. For a 1200 baud data line this is about 2.4KHz.

As a rule of thumb the bandwidth of a channel must be at least twice the highest frequency you want to transmit. This is because the transition of a signal from one level to another, if done quickly – as it is if digital signals are being used – contains a very large number of harmonics.

If the bandwidth of the channel is insufficient to allow some of these through you will have great difficulty in detecting the transition at the other end.

So the greater the bandwidth of a channel the faster you can send transitions down it, and the more information can be passed.

Now some transmission media such as microwave links, fibre optics and satellites have very wide bandwidth channels. It is very rare that one device will want to communicate with another at such a speed that it needs to use all the capacity of the channel.

So unless something is done a lot of this capacity will go to waste. The answer is to share the channel with others.

However this must be done in such a way as to look as if you had a channel of your own. This can be done in a way known as multiplexing.

There are two types of multiplexing – frequency division and time division. Frequency division multiplexing is mainly used for audio telephone lines. It involves modulating the audio signal at some higher frequency.

Modulation is the process of putting

information onto another waveform. In mathematical terms the information is known as the modulating waveform and is multiplied by the carrier waveform.

This changes the size or amplitude of the carrier waveform at the same rate as the modulating waveform. It is therefore known as amplitude modulation or AM for short and is the way most long and medium wave radio transmissions take place.

In order for it to work properly the carrier wave has to be many times higher in frequency than the modulating wave.

Each telephone call is modulated at a different frequency and the whole lot is sent down the long distance telephone lines. At the other end a demultiplexer filters out each channel and transfers it to its own local line. This is just like having a number of different radio sets all tuned to a separate station.

The cause of some crossed lines is the mistuning of these “radio sets”. Nevertheless it allows many calls to be made simultaneously on one channel.

In practice it is a little more complex, with several telephone calls being multiplexed together into a group and several groups are further modulated into a super group.

One of the reasons why British Telecom wants to approve even acoustic-coupled modems is that if a

signal which is too loud is sent down the line it would interfere with adjacent channels in these groups, due to overmodulation of the signals.

Most digital signals such as those from a computer or from digitised telephone conversations use time division multiplexing. Here you have exclusive use of the channel for a very short time but you can pass so much data over in that short time that you do not notice the difference.

At the multiplexing end a buffer gathers your data until it is your time to use the channel. When that time comes it is squirted at high speed down the channel and a buffer at the other end catches it, stores it and slowly releases it to the receiving equipment.

Providing you have a “turn” often enough you do not notice you are sharing a line. This technique is used when you want a private line between two devices.

Very often in computing we wish to communicate with more than one device and so we can use a variant on time division multiplexing known as packet switching.

This is how computer networks work. All the communicating devices are connected together by a common channel. This is usually some form of co-axial cable, but could be anything – even a radio link. The points that con-

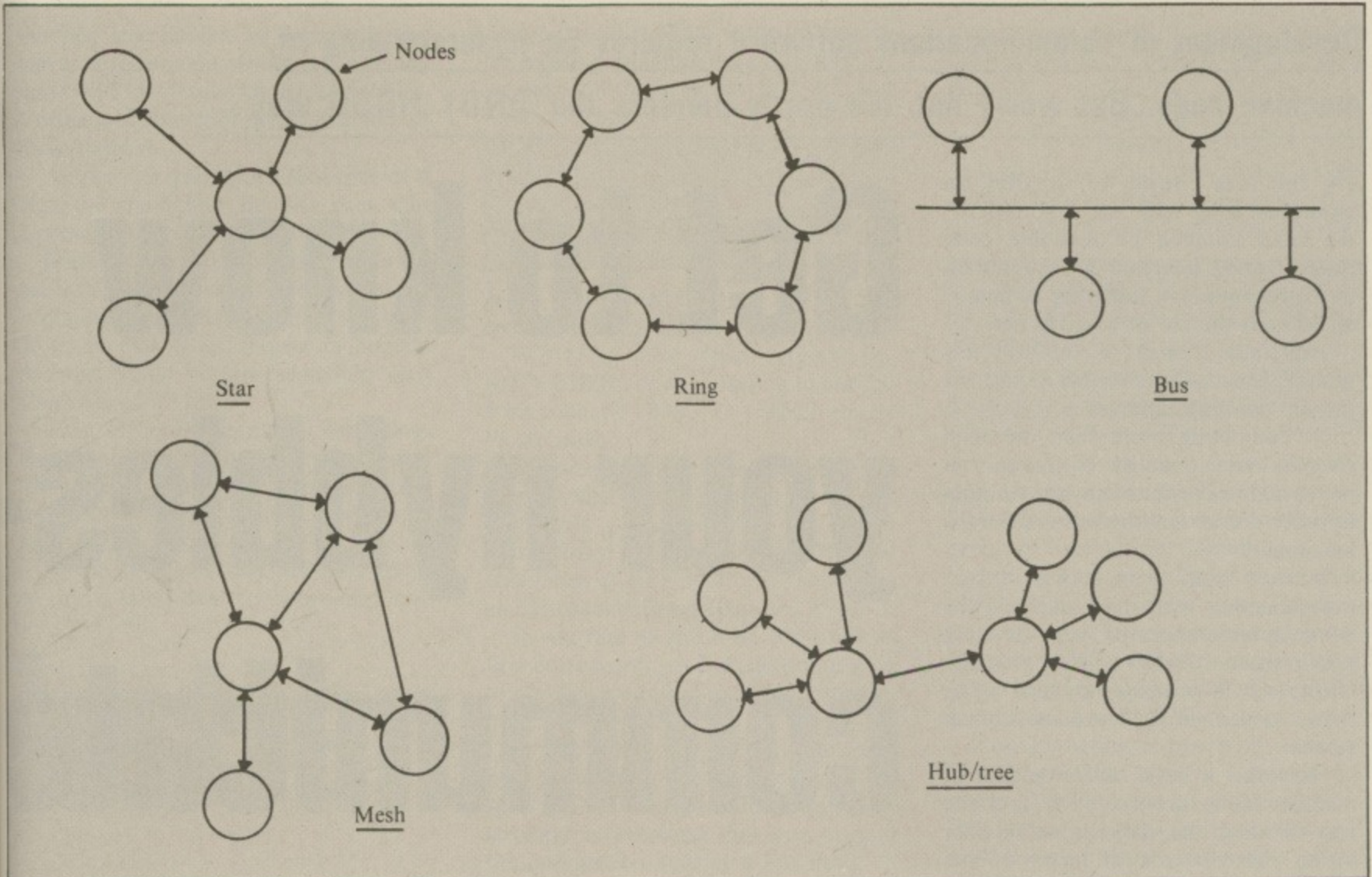

Figure 1: Network topologies

nect to the line are known as nodes and there are several ways these can be connected (see Figure 1).

As this channel has a high capacity all the nodes work at the maximum baud rate.

When one node wants to communicate with another it sends its message in a series of bursts or packages. The packages contain not only the message but also information about who sent it and who it is for. Thus it is possible to send a message to more than one node simultaneously.

A message, by the way, is usually some data or program you want to pass, although it could be a request for information such as: "What's the weather like where you are?"

This is all well and good, but what happens when two nodes want to use the channel at the same time? If this happens it is known, appropriately, as a collision and is where a number of different schemes can come into play making one computer network incompatible with another.

In one scheme called collision avoidance, the node waits until the line is free and then waits a random length of time. If the line is still free it then sends a message to the other node saying: "Are

you free?"

If it receives an answer within a certain time it knows that nobody else is using the line and carries on sending packages to the node. It then has full access to the line until it finishes.

The only time a collision can occur is during the initial call, and if an answer is not received after a set time it knows a collision must have occurred and so backs off and tries again later.

As there is a random delay the odds are that one device will get in before any other and establish a link. This is the basis behind the networking system used on Lisa and Macintosh. They call it Applebus, but the same type of scheme is used with many networks.

The network most readers will have heard about is Econet, as it is the one that can be used with the BBC Micro. This uses a different scheme - collision detection. With this system a clock signal is distributed to all the nodes which divides the time up into packets so each node knows when each packet time starts.

When a node wants to send it waits until it sees a free package and then sends its message in the next one.

But as well as transmitting it also listens to its own transmission. If it does

not hear exactly what it has transmitted it backs off and waits a random time before trying again.

Thus with several nodes trying to access simultaneously one will eventually get in first.

With all these schemes a point is reached when traffic along the channels is so great that the system breaks down or runs very slowly. It is then that the large network is split into smaller ones that are networked together. Then a packet finds its destination by being switched from one network to another.

On the Econet system this linking of networks is known as a bridge, and packets can be switched by network controllers and sent over the appropriate bridge. Exactly what happens depends on the type of interconnecting network you have.

If you think this is all too remote to ever concern you there are groups of radio amateurs who are planning a packet switched radio link for their computers. And one of the nodes proposed is an amateur radio communications satellite!

There are exciting moves afoot in this area of communications so it's time to start thinking about what you are going to say!

Development of communications software requires an understanding of machine code. But worry not, it's pretty painless the ANDY HOOD way . . .

IN the last couple of articles on communicating with the BBC Micro* we have touched on machine code programming, interrupt driven routines, and streaming and buffering of data – all without the aid of a safety net!

Hopefully though, in the last few months some of the mystery behind the jargon has been removed.

In computing more than anything else the very quantity of jargon can prove quite a barrier to anyone wanting to probe deeper into the workings of the machine.

I know that when I first started experimenting with machine code the whole subject appeared very daunting and it seemed highly unlikely that my efforts would produce anything other than a locked out keyboard and a blank screen.

However, a basic understanding of machine code programming and the way in which the micro stores its data yields rich rewards in terms of the additional speed and power obtained by talking to the BBC in its natural language – even if the process of learning can be a bit heavy on the Ctrl + Break keys!

To progress further with the development of our communications software this basic understanding becomes necessary.

While it would be impossible to fully cover machine code programming in this short article, I would like to describe some of the fundamental building blocks so that you can have as much fun experimenting and learning as I have had.

The first and most obvious question is why is machine code so much faster and powerful than the Basic interpreter supplied with your micro? The answer really is in that word interpreter.

Imagine being in a non-English speaking country and having to quickly convey a message to someone. You have two ways of doing it.

One method is, of course, to speak to the person in their native language. But this requires you to have already learned that language.

The second method is to find yourself an interpreter who will listen to what you say in English, make sure that he

* *The Micro User*, July (Page 127) and September (Page 116).

Get to know your nybbles - communicate

understands it, and then convert it to its nearest equivalent in the native language.

You can readily see which will be the quicker and give more freedom of expression.

This is a pretty fair analogy to the relationship between machine code and interpreted languages such as Basic.

At this point you may be wondering where that thing called an assembler fits in between Basic and machine code. To understand this we first need to look at the way machine code, and indeed any data, is stored in the micro.

The BBC Micro is an electrical piece of equipment and as such really only has two conditions: it is either on or it is off. Likewise all of the circuits within it have the same two basic conditions.

To represent these two states we use a numbering system known as binary, where a 0 indicates the off condition and a 1 the on condition.

Great stuff so far. But being limited to counting up to 1 could be a bit of a handicap and this is where the code comes in.

In order to represent a number greater than one we have to group together a sequence of *ons* and *offs*, each of which forms a bit of the code.

The 6502 processor, the thing that does the de-coding in the BBC, looks at eight of these bits at a time. We

arbitrarily call these 8 bit chunks a 'byte'.

So if there are 8 bits in this byte and each bit has two states – on or off – we can represent in one byte numbers up to $2^8 - 1$, that is:

$$2 * 2 * 2 * 2 * 2 * 2 * 2 * 2 - 1$$

which equals the very familiar total of 255.

Numbering the bits from 0 to 7, each bit represents the number of units as shown below:

one byte									
bit	7	6	5	4	3	2	1	0	
value if on	128	64	32	16	8	4	2	1	total 255
value if off	0	0	0	0	0	0	0	0	0

So if we wished to pass the value of 65 to the processor we would need to send a byte with bits 0 and 6 on to give $1 + 64 = 65$.

Having got bits and bytes sorted out we can now see a reason for the apparently unnecessary additional complication of hexadecimal notation, which is defined by preceding the number with &.

As writing 8 bits down every time we wish to think of a number can be a bit –

(no pun intended!) – of a strain, some clever devil thought of splitting the 8 bits into two 4 bit chunks known as nybbles. I often wonder who on earth thinks of these names!

Anyway, if you take a sequence of 4 bits, the maximum number they can represent is $2^4 - 1$ which equals 15.

Looking at the bit pattern above we see that if all of these bits were set – that is, the number equalled 255 – writing it down in two 4 bit chunks in normal decimal would be represented by two 15s, that is, 1515.

This, of course, is totally confusing. Being very logical computer programmers, we would use a numbering system where one character could represent 0 to 15 units.

As single digits in decimal only go up to nine we have to represent the

e better

numbers 10 to 15 with the letters A to F, where A=10, B=11 and so on up to F=15.

You can now see that all bits set (255 decimal) can be represented by &FF instead of 1515. The 4 bits in the high nybble – the highest numbered section of the byte – being the first F and the bits in the low nybble being the second F and the decimal equivalent being $(15 \times 16) + 15$ or 255.

Phew! Told you it was easy, didn't I?

This numbering system is called hexadecimal after the Greek for 16, as a total of 16 different numbers – 0 to 15 – can be represented by each hex digit.

“Why not just use decimal?” I hear you ask.

Well, decimal is fine for most operations and there is certainly no reason not to use it. However, in our field of communications, where data is sent in certain bit formats, an understanding of binary and the way in which hex can easily represent binary patterns is very useful – as you will see later.

Just to recap. A byte is made up of 8 bits and can represent any number between 0 and 255.

The hexadecimal (base 16) numbering system provides an easy way of deducing which bits are set in a byte by breaking up the 8 bit pattern into two 4 bit patterns.

For example: What is the bit pattern for a byte containing the value &4F? If we take the high nybble first &4 and remembering:

bit	3	2	1	0
value if set	8	4	2	1

&4 is represented by 0100 and the low nybble &F (15 dec) is 1111.

Writing the two together, &4F=01001111 or, referring to our full 8 bit code, $64 + 8 + 4 + 2 + 1$ which equals 79 decimal.

Of course using a base 16 numbering system where each position to the left represents a multiplication by 16 we could have arrived at the decimal equivalent of &4F by $4 \times 16 + 15 = 79$ just as 23 in decimal base 10 means $2 \times 10 + 3$.

If you find all this a bit confusing at first don't worry – it does take quite a bit of practice to think in a different number base.

Trying out a few conversions from hex to 8 bit binary code and decimal will soon get you familiar with it though. I strongly recommend that you re-read the last section and try a few out.

Right, back to the assembler.

The 6502 processor expects to receive all its instructions in this 8 bit code and in order to help us program it without having to write down a string of fairly unintelligible numbers the assembler converts more meaningful mnemonics, or labels, directly into this machine code.

This has the added advantage that by writing the code with an assembler other programmers can read and hopefully understand your programs.

So, now we understand the system of bits and bytes, how do we apply our knowledge?

As you would expect the BBC, in common with most other micros, has a set of commands in both Basic and assembler to alter directly the state of any or all bits within a byte.

These are known as logical or bitwise operators. The three that are common to both Basic and assembler are AND, OR and EOR.

AND is primarily used to zero or reset selective bits and works, like the other two instructions, by the use of mask byte.

Any reset bits – zeros – in the mask byte will cause the corresponding bits in the target byte to become zero. It is probably easier to understand if we take an example.

Say we have a Basic program where

the user is asked to enter a letter corresponding to options on a menu, such as:

A – Alter Record.

D – Delete Record.

If we have a normal routine which checks for the Ascii equivalents of A and D it might look something like this:

```

100 character = GET
110 IF ASC(character) = 65 THEN
PROCalter : REM ASC("A") = 65
120 IF ASC(character) = 68 THEN
PROCdelete : REM ASC("D") = 68

```

However if the user enters a lower case *a* or *d* our routine will not recognise it and this obviously does not make the program terribly user friendly.

A close look at the list of Ascii codes – see Page 486 of the User Guide – shows us that the upper case alphabet starts at code 65 and the corresponding lower case alphabet is shifted up by 32 and starts at code 97.

Looking again at our 8 bit code we can see that the bit five indicates the value 32 and so this bit is always set – that is, has value 1 – in the lower case alphabet and clear – value 0 – in the upper case codes.

A simple way round our input problem would then be to reset the fifth bit of any lower case character input to convert it to upper case.

To do this we must provide a mask byte with all bits set except for bit 5. This is where hex representation can make life a little easier for us.

As in the earlier example we take the high and low 4 bit nybbles separately.

The high nybble will have all bits set except number 5 and so will look like this:

bit	7	6	5	4
value	1	1	0	1

which, using our 4 bit system, gives 13 decimal or &D.

The low nybble will have all bits set and so will give 15 decimal or &F.

The mask byte we want is then &DF or 11011111.

If we then add a line 105 into our routine:

```

105 character = character AND &DF

```

we will automatically convert all lower case input into upper case before carrying out our checks.

The rule for AND is then:

To clear bits to 0, place 0s in the

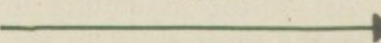

From Page 157

mask to ensure that corresponding bits are at 0.

Place 1s in the mask to leave existing bits unchanged.

The next logical operator is OR and, as a complement to AND, its rule is:

To set bits to 1, place 1s in the mask to ensure corresponding bits are at 1.

Place 0s in the mask to leave existing bits unchanged.

So to convert from upper case to lower case we could use a mask with only bit 5 set or:

0010	0000	
^	^	
2	0	=&20

So our program line would read:

```
105 character = character OR &20
```

The final operator is EOR whose function is to change selected bits and its rule is:

To change bits place 1s in the mask to ensure that the corresponding bits are changed.

Place 0s in the mask to leave bits undisturbed.

Well, that's about it on bytes, nybbles and bit manipulation and with hardly a pause for breath we'll move on to registers.

The 6502 has three registers known as the A, X and Y registers. Each can be likened to a memory location that can hold a single 8 bit byte.

The A or accumulator register is the main workhorse of the system and is the only register with arithmetic capabilities, these being limited to straight addition and subtraction.

The X and Y registers are similar but have no arithmetic capability other than by being incremented or decremented by 1.

All three registers can be loaded with data or the contents of a memory location and can store data in memory or transfer it between each other.

The other main device in the 6502 is something called the stack, which is used for temporarily holding a copy of data pushed onto it from the A register.

The word stack accurately describes the way in which it operates, as to get at the first byte in a series of, say, five transferred to it you must first take off the last four. This system is known as LIFO for Last In First Out.

All of the assembler instructions affecting these registers are, as I have

mentioned before, known as mnemonics.

This means that the name of each instruction gives an indication of its function.

For instance:

STA - *STore Accumulator*
STX - *STore X register*
LDA - *LoaD Accumulator*
JMP - *JuMP to memory location*
JSR - *Jump to SubRoutine*
RTS - *ReTURN from Subroutine*
PHA - *Push Accumulator (onto the stack)*

and so on.

You can see from these examples that the very nature of mnemonics helps us to decipher just what type of operation the assembler is asking the processor to carry out.

Coupled with an understanding of the way in which data that the operation refers to is stored, programs like the Micro-Term listing given in the September 1984 issue of *The Micro User* can be more easily read and understood.

Finally, let's apply some of the concepts we've looked at this month to extend the capabilities of Micro-Term.

During previous articles I have mentioned how data is sent via the RS423 is transmitted in a particular bit format.

All of these formats are slight variations on the internal 8 bit code that we have been looking at. In order for two systems to communicate properly they must, of course, be exactly matched.

All data sent via the RS423 is preceded by one start bit to synchronise the transmitter and receiver. The actual character code is then sent in either 7 bits - if no code outside the normal Ascii range of 0 to 127 is required - or a full 8 bits.

Following these character bits is an optional parity bit which, if selected, is an additional bit sent to either:

If parity is even - make the total number of set bits an even number.

or

If parity is odd - make the total number of set bits an odd number.

Finally an optional stop bit or bits may be sent to signal the end of that particular character code.

On the BBC Micro the current setting of these options is held in the RS423 control register located in one 8 bit byte at memory address &FE08.

Bits 2, 3 and 4 of this memory location are dedicated to the control of these options giving a possible 2^3 or 8

different settings and these are listed below:

bit4	bit3	bit2	bits in word	parity	stop bits
0	0	0	7	even	2
0	0	1	7	odd	2
0	1	0	7	even	1
0	1	1	7	odd	1
1	0	0	8	none	2
1	0	1	8	none	1
1	1	0	8	even	1
1	1	1	8	odd	1

Direct poking of this memory address is definitely not advised as the other bits in the 8 bit word control important functions and so must be left unaltered when changing the word format.

The MOS command that accesses this location is OSBYTE 156 and in common with all other MOS calls above &A6 (166) it works like this:

new contents = (old contents AND Y) EOR X.

It is important then to establish the correct mask for the Y register that will zero bits 2 and 4 and leave all others unchanged.

So we're back to our 4 bit nybbles!

The upper nybble is then 1110 =&E and the lower nybble is then 0011 =&3 giving us a mask byte of &E3 or decimal 227.

Remembering that EOR changes selected bits we can now load the X register with one of the bit patterns in the table above.

To change to a 7 bit word, odd parity, 1 stop bit setting we need then to set bit 2 in the X register so we would load X with 0000 0100 which is, of course, &04.

Our program to execute the change would then be *FX 156,227,4 in Basic.

In assembler this would be:

```
OSBYTE=&FFF4
LDA &90 : REM = 156 decimal
LDX &04 : REM = 4
LDY &E3 : REM = 227
JSR OSBYTE : REM do the FX call
```

With one additional routine we can configure the RS423 to any of the standard settings used by the many different bulletin board and mainframe systems.

This month we have covered an enormous amount of ground. All those bytes, bits and assembler mnemonics were not so difficult, were they?

Next time we'll see how to put them to good use...

A user's guide to



presented with a second menu, quite similar to the Quick-scan one, but with two additional options:

```

(F)orward or (R)everse Multiple
(N)ew Messages
(M)arked Messages
(S)elective Retrieval
(I)ndividual Message(s)
(A)abort Retrieve
Which One?
    
```

Here you can read all public messages from first to last or vice-versa, read only messages new to you since your last log-on, or select messages between certain numbers or by subject material.

The additional Marked messages allows you to read only messages which you have previously marked for retrieval during your quick scan, and the Individual messages permits you to select any particular message by number. After keying in your selection the final prompt before you read the messages is:

```
Pause after each message(Y/N)?
```

If you answer Y to this each message will pause at its conclusion with:

```
<N>ext msg, <R>eply or <S>top?
```

One final point worthy of note. Anybody can reply to a public message. Any message with such a reply will be followed by:

```
Msg has replies. Read now(Y/N)?
```

If your answer is Y Microweb will jump to the replies. Once you have finished reading them you are presented with the following options:

```
<N>ext msg, <R>eply, or <S>top?
```

If the reply is to a message originated by yourself, you are provided with an additional option of Deleting the reply once you have read it.

Well that's all for this session. I hope it's encouraged you to log-on to Microweb soon.

When you do you will join a user log in excess of 1,600 names already, originating from places as far afield as Switzerland, Norway, Germany, France and even Australia.

Alan McLachlan

IN September's *Micro User* we briefly led you through the procedures for logging on to Microweb, our own bulletin board. We finished with a quick look at the top level menu and the options for leaving messages for other people, whether for public or private reading.

This brings us to the other reason for using a bulletin board - reading messages, either your own personal mail or general messages.

```

MICROWEB Top Level Menu
=====
<R>ead.....Microweb messages
<Q>uick-scan..Microweb messages
<L>eave.....Microweb messages
<M>ail.....Electronic mail section
<T>ime.....Elapsed time
<P>roblem.....Page
<G>oodbye.....Terminate session
<D>ownload....,Programs
<F>ormat.....Reconfigure terminal
<X>pert.....Change user level
<C>hat.....Talk to Sysop
<N>ews.....Latest happenings
    
```

There are two selections on the top level menu that permit you to read messages - R and Q.

The Quick-scan option allows you to skip through all the public message boards marking any message that you want to look at in detail later. At this level you're presented with only the headers and subject headings of each message.

A typical scanned message will appear like this:

```

Msg#: 927 *MICROWEB*
Subj: COLOUR SCREEN DUMP
07/07/84 03:07:59 (Read 318 Times)
From: TANDY COMPUTER CTR
To: ALL BBC OWNERS
    
```

After selecting Q a description of the control options P, S and N appears. These can be used at any time while reading messages, as shown in the following prompt:

```
Type P to pause, S to stop, N to skip to next msg
```

P will enable you to pause as the scan progresses. S will stop it immediately and return you to the current menu while N moves you onto the next message.

As I've already implied, these prompts are not peculiar to the

● The number to ring for Microweb is 061-456 4157. We're a 24 hour service operating at 300 baud full duplex.
If you haven't got a modem or communications software yet, now's the time to take advantage of our special offer on Page 210.

Quick-scan menu but are standard throughout Microweb for all message reading menus.

The Quick-scan menu is then displayed:

```

<F>orward Scan
<R>everse Scan
<N>ew Message Scan
<S>elective Scan
<A>abort Scan
Which One?
    
```

In this menu F and R will take you forwards or backwards through the messages. That is F displays messages in numerical order whereas R displays them in reverse order. The latter may seem odd, but sometimes you may just want to scan through the latest additions to the board.

N will show only messages new to you since your last log-on. S allows you to select a scan either from a number to a number or by subject material. Finally A aborts the scan and returns you to the current menu.

Any selection from the menu results in the following prompt for "marking":

```
Mark for Later Retrieval?
```

Answering this with a Y will ensure that after each message is displayed you are given the options of "tagging" it to inspect in detail later. It looks like this:

```

Msg#: 1199 *MICROWEB*
Subj: MAG
07/17/84 06:01:05 (Read 240 Times)
From: MIKE HOUGHTON
To: MICRO USER STAFF
Mark? (Y/N)
    
```

This facility allows you to recall and read any complete message once you have returned to the current menu.

Having made your decision about the marking prompt, you will then be presented with the following information (with of course varying numbers):

```
The System has Msg's 909 to 3461 Starting Number, <CR>=First:
```

You can now select which message you wish your scan to start at.

If you enter Return and the first message you are shown is several numbers later, don't assume there is something amiss. It just means that the missing messages are either private ones, on another message board or awaiting purging by the Sysop (System Operator), having been marked for deletion.

When your scan is complete you will return once again to the current level menu where you can select the option to Read Microweb messages. In fact you have to do this to read the messages you have marked. You will again be

NOW GRAPHS AND CHARTS ARE EASY!

WITH **BEL GRAPH** FROM **BEL TECH** FOR **BBC, ELECTRON** AND **SPECTRUM**

POWERFUL, SOPHISTICATED YET MENU DRIVEN AND EASY TO USE and INCREDIBLE VALUE FOR MONEY !!!

- ** AUTOMATIC SCALING and DRAWING OF AXES **
- * DATA ENTRY FROM KEYBOARD OR FILE (4 FIELDS X, Y, Z, T)
- * SELECT DISC DRIVE (where applicable)
- * SORT on 'T' or Θ FIELD
- * ACCEPT/REJECT RECORDS and FIELDS on DATA ENTRY
- * EDIT
- * SAVE FILE
- * SCREEN DUMP FACILITY (or combine your own)
- * RENAME FIELDS
- * DEFAULT VALUES for WEEKS/MONTHS
- * LINE GRAPHS
- * BAR CHARTS/HISTOGRAMS
- * PIE CHARTS
- * VERTICAL BAR CHART
- * COMBINED BAR/PIE CHART
- * ENTER EQUATIONS IN X, Y or PARAMETRICS X, Y, Θ
- * ANGLES IN RADIANS or DEGREES
- * PLOT $X\Theta$, $Y\Theta$, YX , $Z\Theta$, XZ , YZ etc.

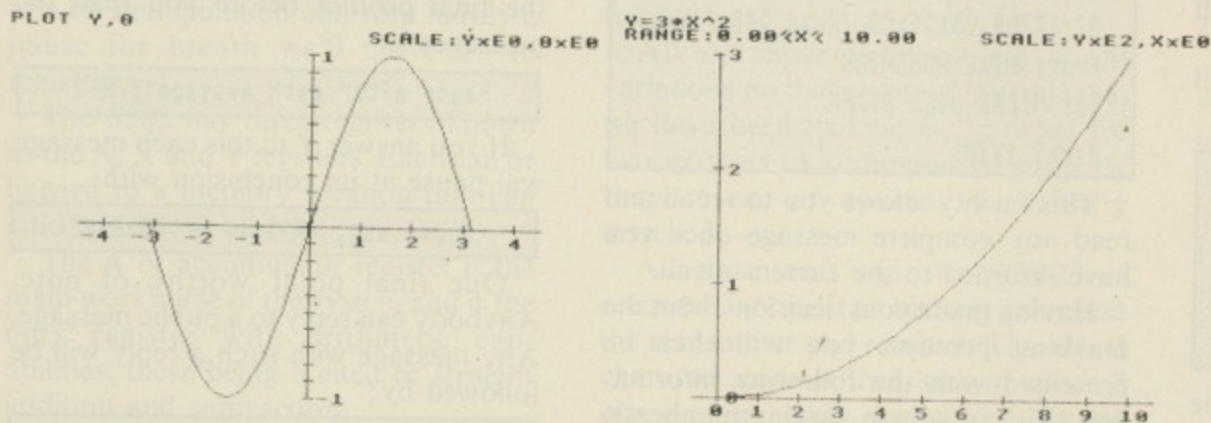
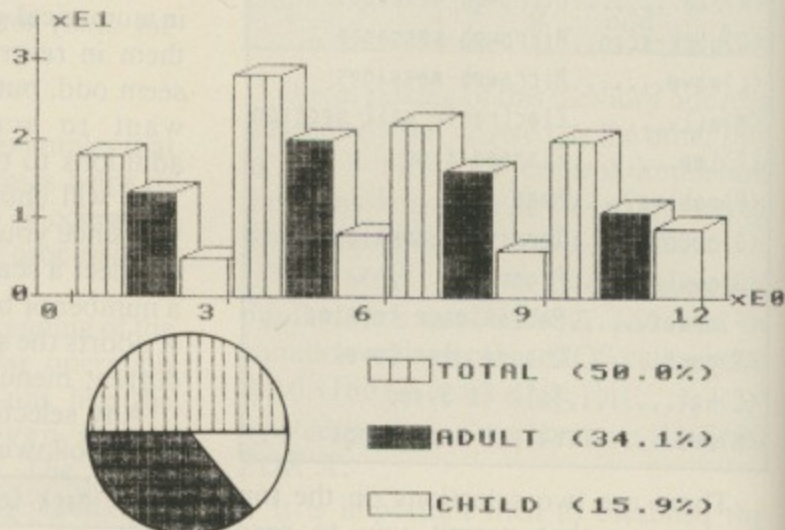

COMPATIBLE WITH BEL BASE and MAILSHOT (Disc) and capable of READING DATA from ANY FILE in stated FORMAT.

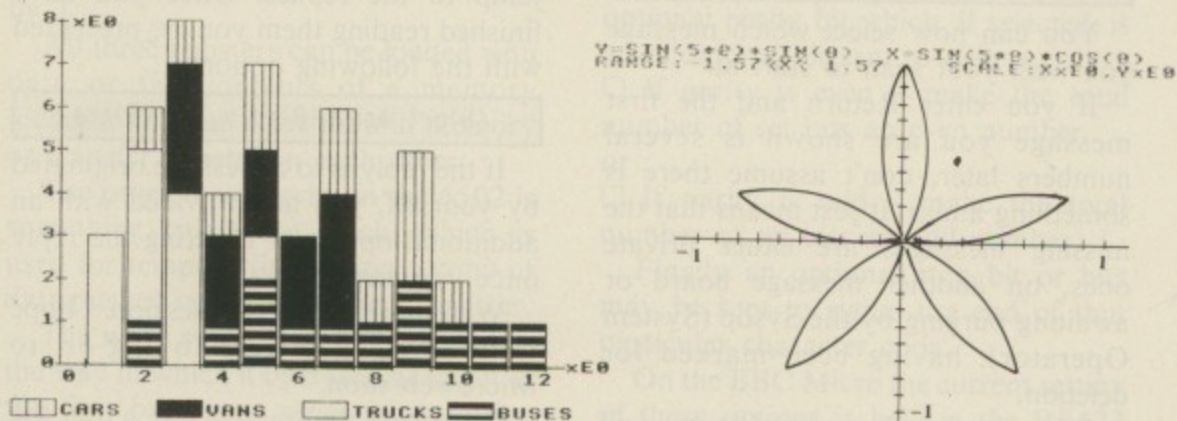

BEL BASE, MAILSHOT and BEL GRAPH
form a superb integrated package for Business, Reports, Clubs, Accounts, Education etc.



Order Form	TAPE	DISC	TOTAL
	QTY	QTY	
BEL BASE	16.00	18.00	
BEL GRAPH	15.00	17.00	
BEL CHEM Chemistry 1	9.50	11.50	
Chemistry 2	9.50	11.50	
BEL GEN Genealogy	15.00	17.00	
MAIL SHOT	9.50	11.50	
BEL PLOT	9.50	11.50	
BEL SUBS	10.50	12.50	

TOTAL inc. P. & P. £

NAME _____

ADDRESS _____

COMPUTER TYPE _____ MODEL _____

DISC (if applic.) _____

CREDIT CARD No. PAYMENT BY CHEQUE, P.O., VISA, ACCESS

Please Complete & Return to:-

BEL TECH Limited, Stanmore Industrial Estate, Bridgnorth, Shropshire, WV15 5HP or

Telephone: 07462 5420 (24 Hrs.)

NOW ON ROM £49 (State Tape/Disc Data Files)
YOU CAN UPGRADE CHEAPLY LATER!

Start with EPSON's best...

... add a sturdy, power-supply upgradeable case, test it thoroughly, package it with all necessary leads and manuals, and add a full year's warranty:

The UDM Disk Drive!

Available through UDM dealers, in single & dual, 40 & 80 track single & double sided, 5¼ & 3½ inch versions with or without power supply for less than you think.

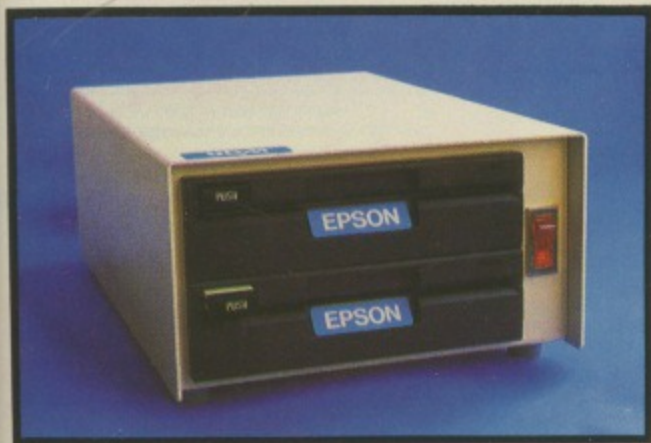

Please forward me details on the Epson/UDM range.
I am interested in becoming a UDM Authorised Dealer.

Name _____

Address _____

UDM Authorized Dealers

Microware	North London	01-281 2431
Microware	Croydon	01-771 6373
Microware	City	01-247 8577
Microware	Stoke	(0782) 269 883
UCC	Bradford	(0274) 390 114
Everyman Computers	N. Ireland	(02656) 62658
Home Technology Centre	Chelmsford	(0245) 359944
Carson Developments	Romford	(0708) 27043

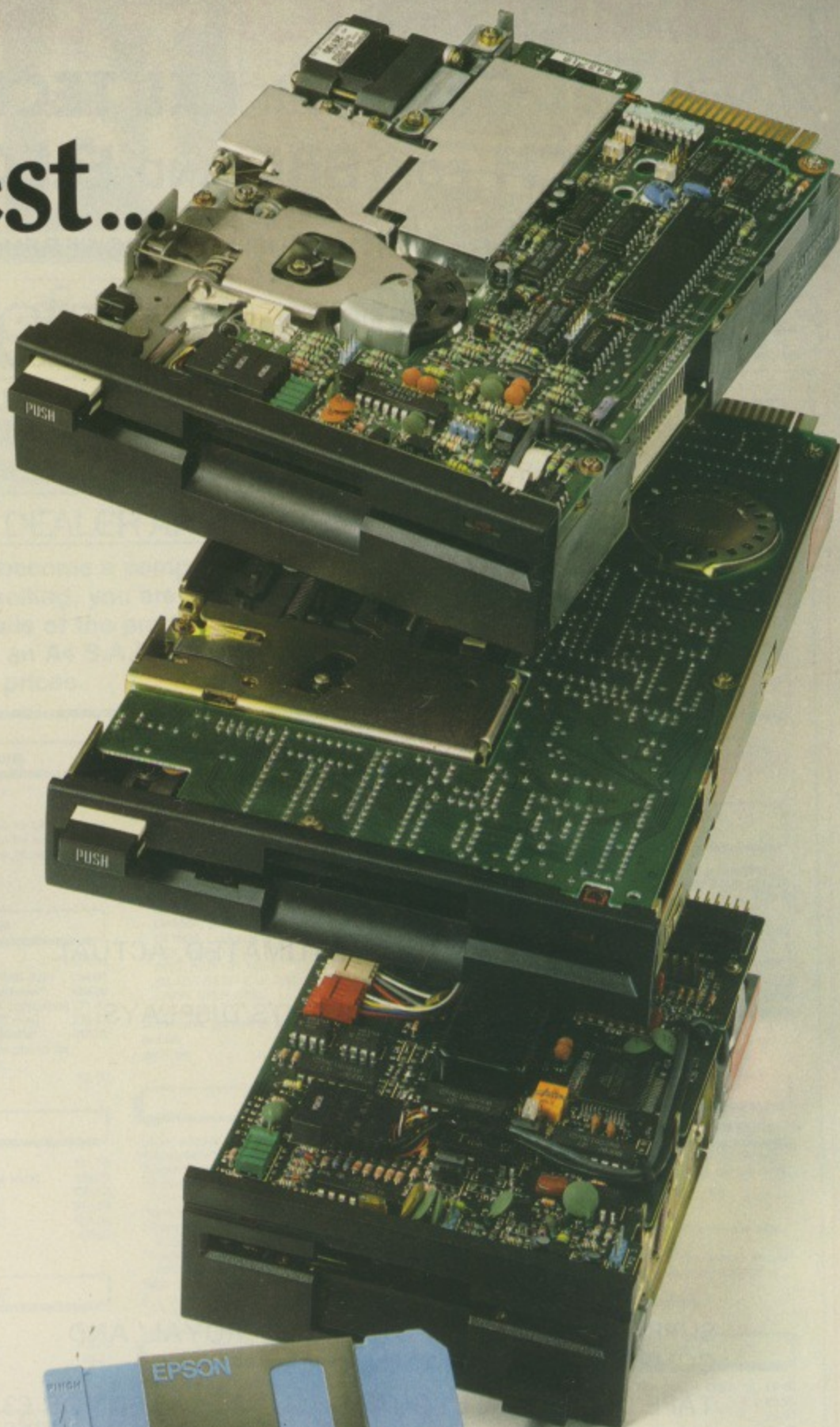

UNITED DISK MEMORIES

STANHOPE HOUSE FAIRBRIDGE ROAD LONDON N19 3HP 01-263 5026

DESIGNS THAT DELIVER
UDM

FAMILY HISTORY COMES ALIVE!

with **BEL GEN** from **BEL TECH**
BEL TECH FOR **BBC** AND **ELECTRON**

DEDICATED DATA BASE WITH ADDITIONAL POWERFUL OPTIONS FOR STUDY AND PLEASURE

- * MENU DRIVEN, SOPHISTICATED but EASY TO USE
- * 360 PEOPLE/FILE on truly RANDOM ACCESS DISC VERSION (720 on 80 TRACK, 75 on TAPE)
- * ADD, BROWSE, SORT (Any Field), CONDITIONAL PRINTS/DISPLAY OWN FORMAT, EDIT, FIND, SAVE, SEND PRINTER CONTROL CHARACTERS, SELECT DISC DRIVES.
- * ALL OPTIONS can be DISPLAYED OR PRINTED
- * FIELDS (TOTAL OF 20) ARE:

FAMILY NAME
 GIVEN NAMES
 GENDER
 OCCUPATION
 PLACE
 DATE of BIRTH/BAPTISM
 DATE of DEATH/BURIAL
 No. of CHILDREN
 SPOUSES (Up to 3)
 DATES OF MARRIAGE
 REMARKS/NOTES

- * ALL DATES can be CIRCA, ESTIMATED, ACTUAL
- ** SPECIAL SEARCHES AND PRINTS/DISPLAYS additional to OWN REPORTS

- * ANY NAME or PLACE
- * No. of CHILDREN
- * GENDER of CHILDREN
- * PERIOD of YEARS
- * ANY FOUR GENERATIONS
- * LONGEVITY

- * SUPPLIED WITH TEST DATA FILE 'ROYAL' AND COMPREHENSIVE MANUAL
- * TAPE USERS CAN UPGRADE TO DISC LATER FOR £3.00

MALE PARENTAL LINE

KEY PERSON: GEORGE WINDSOR

SAXE-COBURG = HANOVER
 ALBERT VICTORIA
 1819-1861 1819-1901
 GERMANY OSBORNE

!
 !
 !

SAXE-COBURG = SAXE-COBURG
 EDWARD ALEXANDRA
 1841-1910 1845-1925
 LONDON DENMARK

!
 !
 !

+

MALE/FEMALE LINE

FAMILY TREE

for any person

on file

+



Order Form	TAPE		DISC		TOTAL
	QTY		QTY		
BEL BASE	16.00		18.00		
BEL GRAPH	15.00		17.00		
BEL CHEM Chemistry 1	9.50		11.50		
Chemistry 2	9.50		11.50		
BEL GEN Geneology	15.00		17.00		
MAIL SHOT	9.50		11.50		
BEL PLOT	9.50		11.50		
BEL SUBS	10.50		12.50		
TOTAL inc. P. & P. £					

NAME _____

ADDRESS _____

COMPUTER TYPE _____ MODEL _____

DISC (if applic.) _____

CREDIT CARD No. PAYMENT BY CHEQUE, P.O. VISA, ACCESS

Please Complete & Return to:-
 BEL TECH Limited, Stanmore Industrial Estate, Bridgnorth,
 Shropshire. WV15 5HP. or
 Telephone: 07462 5420 (24 Hrs.)

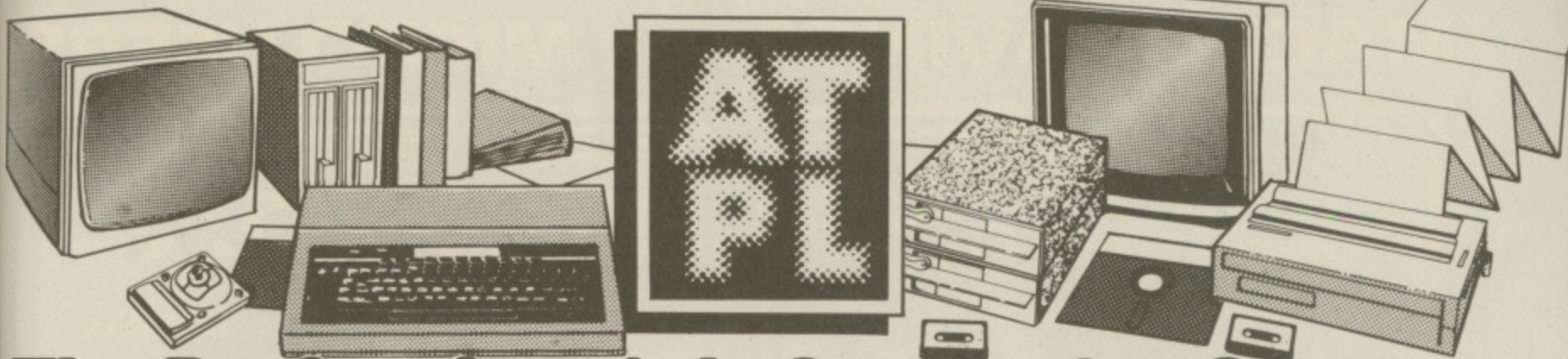

The Professionals in Computing Systems

We offer a design development and manufacturing service for companies wishing to improve their products using Microprocessor Technology.

COMPUTER DEALER ANNOUNCEMENT

ATPL have now become a computer dealer, by mail order, or direct selling, you are welcome to call and discuss any details of the products listed below, or alternately send an A4 S.A.E. to us for full Technical Data, and latest prices.

ATPL PRODUCTS

BREAK-FAST Prevents accidental use of the BREAK key and unauthorized use of the computer.	£8.60
SIDEWISE BBC ROM expansion board.	£38.00
Battery back-up kit for CMOS RAM'S.	£17.00
CMOS RAM 8K x 8bits, (6264LP5565PL).	£45.00
Free printer buffer software (spoolit) with every 2 CMOS RAM Sold.	
AUTOPROM EPROM programmer for the BBC.	£120.00
OCTOPROM EPROM programmer blow 8 EPROM'S at once (BBC).	£297.00
INSIDEOUT extends one SW ROM socket out of the BBC.	£13.00
p + p	£1.00

ATPL DISC BASED SOFTWARE

SPOOLIT printer buffer on ATPL'S sidewise RAM. (disc)	£12.50
TURBOPROM 1 fast programming Algorithm for AUTOPROM. (disc)	£12.50
TURBOPROM 2 Sideways ROM version of above. (ROM)	£15.00
DFS SHIFT moves DFS workspace to CMOS RAM on sidewise. (disc)	£12.50
SIDEWIPE put sideways ROMS onto disc direct from the BBC.	£12.50
p + p	£1.00

OTHER PRODUCTS ON THE WAY

ATPL SYMPHONY. A very reasonably priced four octave electronic keyboard which allows you to fully exploit the music capabilities of the BBC micro. Price and full details on application.

CIS a range of input/output modules and software for the BBC micro designed specifically as a teaching tool for application of microcomputers in industrial control. Emphasis is placed on the role of programmable controllers in industry. Price on application.

Other products are being developed all the time, an extension ROM to BASIC, a network system, extension switched mode power supply, and many more, please phone if you have a specific requirement.

ROBOGRAPHICS SYSTEM—COMPUTER AIDED DESIGN

ATPL are accredited dealers for the ROBOGRAPHICS CAD system. The most widely used system in the UK provides an ideal entry to computer aided design. A precision scale drawing general purpose 2-D draughting tool. Ideal for architecture, electrical and mechanical engineering, PCB design, control panels etc.

An APPLE based system:

ROBO500 general software/control pack.	£295.00
ROBO1000 scale drawing software/control pack.	£595.00
ROBO1500 precision drawing software/control pack.	£1095.00

Supports most plotters.

Fully integrated system including computer, disc drives and A3 plotter from £3,603

Please call for details, demonstrations can be arranged.

carriage from	£9.00
---------------	-------

COMPUTERS

BBC Model B	£339.15
BBC Model B + disc interface	£398.65
BBC Model B + econet interface	£379.10
BBC Model B + disc + econet	£438.60
ACORN ELECTRON	£169.15
COMMODORE 64	£194.85
SINCLAIR SPECTRUM 48k carriage	£110.00
	£9.00

SECOND PROCESSORS

ACORN 6502	£169.15
ACORN Z80 + FREE SOFTWARE (phone for latest prices)	
TORCH Z80 BOARD (phone for latest prices)	
TORCH DISC PACK (phone for latest prices)	
ACORN BIT STIK	£318.75
Carriage	£9.00

COMMUNICATIONS

ACORN Teletext adaptor	£191.25
PRISM Modem VTX5000 (SPECTRUM 48k)	£84.58
PRISM Modem VTX1000 (Basic hardwired)	£59.08
PRISM Modem VTX2000 (Software controlled)	£71.40
PRISM Communications pack (BBC rom)	£16.57
PRISM Communications pack (Cassette)	£12.33
Other modems are available, please phone for details.	
p + p	£2.50

JOYSTICKS

ACORN/BBC Joysticks	£11.48
SURE SHOT Centre loaded (Single stick)	£15.73
SURE SHOT Centre loaded (Twin)	£29.33
QUICK SHOT II (Atari type)	£10.63
WIZARD Interface (uses Atari stick)	£12.33
p + p	£2.50

CASSETTE UNITS

ACORN/BBC Data recorder	£25.07
COMMODORE C2N Cassette unit	£37.83
ACORN/BBC Cassette leads	£3.23
p + p	£2.50

DISC DRIVES PACE OR CUMANA

CSX100 100K 40T Single sided, double density	£145.64
CSX200 200K 80T Single sided, double density	£187.85
CSX400 400K 80T Double sided, double density	£210.16
CS 100 100K 40T S.S. D.D. + P.S.U.	£165.20
CS 200 200K 80T S.S. D.D. + P.S.U.	£204.30
CS 400 400K 80T D.S. D.D. + P.S.U.	£227.78

TWIN DISC DRIVES

CD 200 2x100K 40T S.S. D.D. + P.S.U.	£298.14
CD 400 2x200K 80T S.S. D.D. + P.S.U.	£377.32
CD 800 2x400K 80T D.S. D.D. + P.S.U.	£421.30
CD 400S 2x200K 80/40T DS DD PSU switch	£458.48
CD 800S 2x400K 80/40T DS DD PSU switch	£487.77
Other disc drives are available, please phone for details.	
carriage	£9.00

PRINTERS

EPSON	
RX80 100cps tractor only.	£272.72
RX80 FT 100cps tractor & friction.	£311.82
FX80 160cps tractor & friction.	£428.15
FX100 160cps 132 characters wide.	£556.20
SEIKOSHA	
5" 40cps dot matrix.	£117.30
GP100AS GP100A serial.	£182.75
GP500A 50cps 10" update of GP100A.	£211.65
GP550A 50cps friction & tractor.	£254.15
GP700A 7 colours 30 shade dot matrix.	£415.65
DAISY WHEELS	
BROTHER HR 13cps.	£430.10
SILVER REED EXP 500.	£292.27
DAISY STEP 2000.	£270.00
JUKI 6100.	£381.65
Many other printers in stock, please phone for latest prices.	
carriage	£9.00

ACCESSORIES

Serial adaptor for EPSON printer.	£60.00
Automatic sheet feeders. From	£215.05
Tractor feeders. From	£78.20
All kinds of cables, for disc drive & printers. From	£8.00
Fanfold paper 2,000 sheets.	£11.90
Floppy disc's double density, single sided 48tpi.	£1.55
Floppy disc's double density, double sided 96tpi.	£2.43
Tape cassettes computer grade C10 or C12.	£0.40
p + p From	£1.00

COMPUTER UPGRADE KITS

Telephone for latest prices.

COVERS & CASES

PVC & Polyester covers for BBC, ELECTRON, COMMODORE etc.	From £3.00 to £36.00.
Soft computer carry case.	£21.21
Hard computer carry case.	£42.26
p + p	£2.50

SOFTWARE & FIRMWARE

System of Sheffield ROMS + Programmes. (phone for latest price)

We carry full stocks of the following products; BEEBLOG (allows authorised users only ROM). £12.75

COMPUTER CONCEPTS ROM'S

BEEBUGSOFT ROM'S + programs

ACORN/ROF ROM'S + programs

RH ELECTRONICS programs

Buy any two products and get 10% off the retail price.

p + p £1.00

MICROVITEC COLOUR MONITORS for BBC, ORIC, QL, 480Z, NASCOM

14" & 20" screens 452 to 895 pixels in plastic or metal cases. From £199.00 carriage. £10.00

MICROVITEC COLOUR MONITORS for IBM, COMMODORE, SPECTRUM, APPLE, DRAGON

14" & 20" screens 452 to 940 pixels in plastic or metal cases. From £210.00 carriage. £10.00

DECCA COLOUR MONITORS PLASTIC CASE

14" standard & medium resolution, all with audio output, RGB/TTL or composite inputs. From £240.00 carriage. £10.00

MONO MONITORS

BBC 12" green screen. £88.83

PHOENIX 12" hi-res green screen. £97.75

Many other monitors in stock, please phone for latest details.

carriage. £10.00

SPECIAL PACKAGES

Buy a total computer package costing over £1,000 from ATPL and choose a free gift from the following:

1. Any computer concepts ROM under £40.00 retail.
2. An ATPL sidewise ROM board, plus battery back-up kit.
3. 2 disc's of ATPL software.
4. 1 8K x 8bits CMOS RAM.
5. Take 2.5% discount from the VAT exclusive total retail price.

Other special packages are available, please phone we will quote you. We offer professional support to all our customer's.

p + p see under respective sections.

CABLE SERVICE

CENTRONICS parallel printer cables BBC	£9.90
DRAGON	£9.90
ORIC	£9.90
CBM64 (including software on cassette)	£19.90
SANYO	£14.90
IBM PC	£19.90
TRS 80	£14.90
SIRIUS VICTOR 2000	£14.90
DISC DRIVE & POWER CABLE FOR THE BBC.	
Signal cable single	£7.10
double	£10.74
Power cable single	£4.10
double	£7.20
dealer enquiries welcome very good discounts available.	
p + p	£0.50

I.C.'s FOR SALE TRY OUR PRICES

Example; 74LS244 £1.00

74LS245 £1.20

these are small quantity prices. Please phone your requirement for instant quotation on IC or MEMORIES.



Station Road, Clowne,
Chesterfield, S43 4AB.
Telephone: (0246)
811585 (4 lines)

CONDITIONS OF SALE & DELIVERY

Cheques made payable to Advanced Technology Products Ltd. please allow 28 days for delivery. Cost of carriage or postage refer to each section. Quantity orders and oversea's carriage charged at cost. Condition of sales available on request.

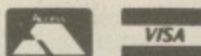

ACCESS AND BARCLAYCARD accepted. Carriage to be added to advertised price, then add VAT to the total.

THE NUMBER ONE ADVENTURE SERIES

Triffid Software Research

Triffid Software Research

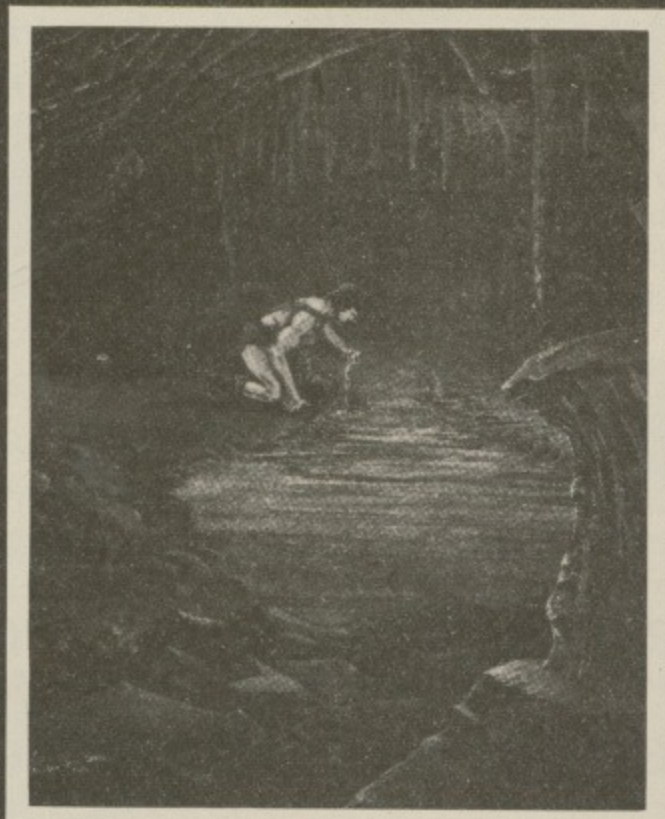

BBC-B
versions
£6-95
each

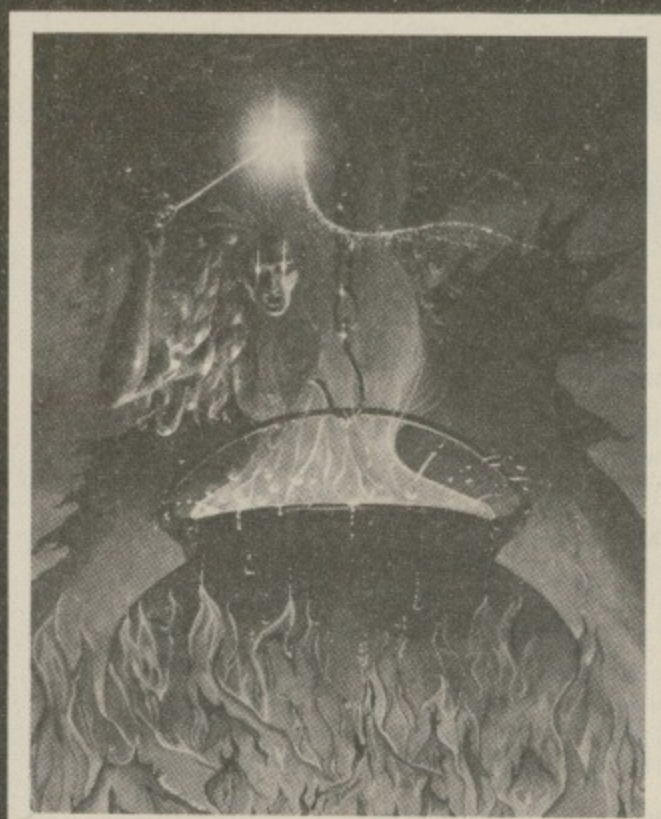

BBC-B RUNEMAGIC SERIES
ADVENTURE ONE
THE SECRET RIVER

BBC-B RUNEMAGIC SERIES
ADVENTURE TWO
THE WIZARD'S CITADEL

1. Load Character Generator (on side one of Adventure One).
2. Dice Character; buy weapon and armour and choose spells.
3. Load Character into Adventure One.
4. If you complete Adventure, then your character will progress in experience, so:
5. Load Character into Generator, rest up, relearn spells and buy better armour (only if you have found enough money on your travels); Save Character.
6. Buy next Adventure in series and load Character in.
7. Go to step 4. Until You have finished Adventure Eight then put your feet up for a well deserved rest.

Available by M/Order (p+p free)
Send cheques or Postal Orders to:

Triffid Software Research
12 Cullwood Lane
Ashley
New Milton
Hampshire
BH25 5QJ



**SPECTRUM 48K,
ELECTRON and
COMMODORE 64**
versions coming soon

Available from good computer
software stores nationwide

Send your software to us.
If accepted,
generous royalties offered.

MAIL ORDER DIVISION

Phone your order on **061-429 8080**

24 hours answering service outside office hours. Or use the order form below
You can also order via Prestel. Mailbox number 614298080 on Enterprise

Personal shoppers can obtain the products advertised on these pages from our retail stores:
Stockport Micro Centre, 36-38 St. Petersgate, Stockport SK1 1HL. (Tel: 061-429 8074)
Wilmslow Micro Centre, 62 Grove Street, Wilmslow, Cheshire. (Tel: 0625 530891)

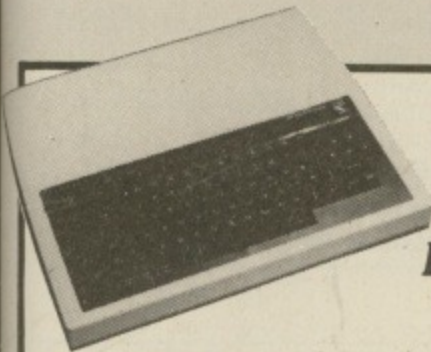

**Buy your
BBC Micro
NOW!**

BBC Model B latest specification OS 1.2 **£328.70**

BBC Model B includes Acorn DFS..... **£387.43**

**At last!
Now available for the
Acorn Z80 Second Processor.**

Wordstar Professional

The last word in word processing systems. Package includes:

Wordstar	MailMerge
Spellstar	Starindex

Only £346.00

We offer the very latest in computer data recorders



Only £26.00
Including Mains Supply Unit

The Morwood Slimline Computer Datacoder, designed specifically with the BBC Computer in mind. As well as offering all the facilities for computer programs and Data loading and Saving, it will also blend in with the colours and design of your BBC Micro.

We bring you the best of both worlds...

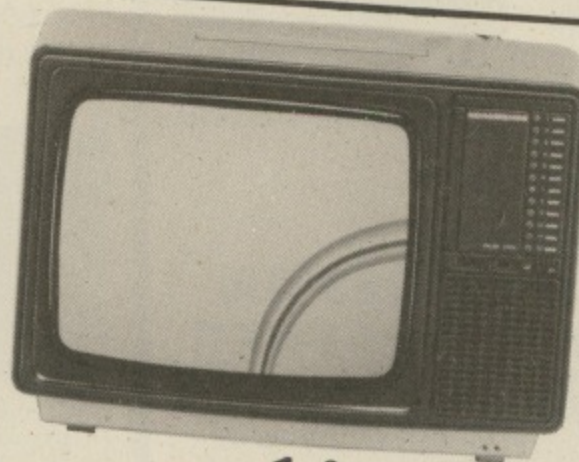

**for only
£206.96**

...a combined portable TV and RGB colour monitor

Here's an ideal answer to arguments about who should use the home TV set. The superbly engineered 14 inch Nordmende has been specially designed for use both as a monitor and a domestic television. Linked to your BBC Micro it gives the crispest possible reproduction of the BBC's colourful graphics, making it ideal for playing arcade games. And you can also use it as a portable TV giving you maximum mobility. Yet the price is less than for many comparable colour monitors - and you get an RGB connecting lead for your BBC Micro as well.

Other Monitors available include:

Zenith 12" Green Screen	£68.00
Microvitec 14" Colour low-res	£189.00
Microvitec 14" Colour med-res	£285.00
Microvitec 14" Colour hi-res	£419.00

The Monitor you've been waiting for

**ONLY
£65.00**

The Philips V7001 12" green screen high resolution computer monitor.



star⁺ ATTRACTIONS

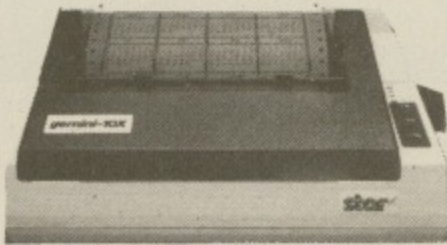

£189.95

+VAT=£218.44
120CPS · Bi-directional
· Logic seeking · Friction
tractor and roll holder
standard · Downloadable
characters · Ultra high
resolution · 80 cols.
· IBM PC version now
available.

GEMINI 10X



12mHZ Video Bandwidth RGB
and Composite Video. Medium Res.

£169.95 + VAT
=£195.44

Also available TV/Monitor
version

@**£195.95 + VAT = £225.34.** 14 INCH COLOUR MONITOR



LOOK!

NEW LOWER PRICES ON EPSON STAR & BROTHER

DAISYWHEEL PRINTERS

BROTHER HR 15	CALL FOR BEST PRICE
EPSON DX 100	£369.95 + VAT=£425.44
JUKI 6100	£325 + VAT=£373.75
DAISYSTEP 2000	£225 + VAT=£258.75

DOT MATRIX PRINTERS

COSMOS JP80	£169.95 + VAT=£195.44
EPSON RX 80	£198.95 + VAT=£228.79
EPSON RX 80F/T	£228.95 + VAT=£263.29
EPSON RX 100	£384.95 + VAT=£442.69
EPSON FX 80	£319.95 + VAT=£367.94
EPSON FX 100	£498.95 + VAT=£573.79
STAR GEMINI-10X	£189.95 + VAT=£218.44
STAR DELTA 10	£319.95 + VAT=£367.94
STAR RADIX 10	£498.95 + VAT=£573.79

THERMAL MATRIX PRINTERS

STAR STX 80	£129.95 + VAT=£149.44
BROTHER HR 5	CALL FOR BEST PRICE
BROTHER EP 44	CALL FOR BEST PRICE

Cables - Paper - Ribbons - Sheet Feeders - Tractor
Feeds - Interfaces - Call for Best Prices



**Credit Card
HOT LINE**



01-482 1711

Please Add £10 + VAT for Delivery
Post your cheques/P.O.'s to:

DATASTAR SYSTEMS UK
UNICOM HOUSE, 182 ROYAL COLLEGE STREET,
LONDON NW1 9NN
Telex: 295931 UNICOM G

Personal callers welcome. We are situated by the junction of
Camden Road, near the railway bridge.

Mon-Fri 9am-6pm. Sat-Sun 10am-1pm.

TAX-FREE EXPORT & DEALER ENQUIRIES WELCOME

NEW HORIZON COMPUTER CENTRES

BBC
CBM 64
SPECTRUM

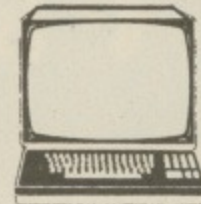

ELECTRON
VIC 20
DRAGON

FOR
EDUCATIONAL
SOFTWARE

FAST MAIL ORDER SERVICE
FREE P&P FOR ORDERS £25 OR MORE
SEND FOOLSCAP S.A.E. FOR CATALOGUE

To: **New Horizon Computer Centres**
1 Goodall Street Walsall WS1 1QU

NEW Adventure for **BBC 32k**

COTTAGE SOFTWARE

Telephone 01-330-1554

You'll score but can you find

The LOST CROWN

£ 5.95

send cheque/P.O.
3, CONRAD DRIVE, WORCESTER PARK, SURREY

The start of a full range of products for the serious BBC Micro user

CROSS ASSEMBLY WITH THE BBC MICRO

CROSSWARE 6801X now provides the professional programmer with the ultimate low cost software development tool. CROSSWARE 6801X combines cross assembler facilities with BBC Basic to allow the full preparation of machine code for the 6801 and 6301 series of single chip microcomputers (including the latest 6303X chip from Hitachi). The full range of facilities of BBC Basic:

- two part assembly, evaluation, procedures, local variables, string handling, arithmetic, logical and bit-wise operators, etc, etc.

The enhanced assembler options available in Basic II:

- assemble for specified origin, equates.

Additional features provided by CROSSWARE:

- Binary number entry, intelligent selection on assembly of short and long jumps, help facility giving opcode syntax and other guidance. Brings together a package to compete with many of the most expensive micro processor development systems . . . and it could not be easier to use.

CROSSWARE 6801X is provided on disc for **£39.95** fully inclusive. Please state whether Basic I, Basic II or HiBasic and specify 40 or 80 track disc.

ENHANCED 65SC02 ASSEMBLER

CROSSWARE 65SC02 adds the missing instructions to the BBC Basic Assembler to allow you to utilise the full the enhanced instruction set of the GTE 65SC02 Second Processor. Once loaded CROSSWARE recognises and assembles all of the additional instructions provided by the 65SC02 just as though they were already included in Basic. A Help facility describes the new operations possible with 65SC02 and also the additional facilities, eg. binary number entry, provided by CROSSWARE.

CROSSWARE 65SC02 is provided on disc for use with HiBasic for **£14.95** fully inclusive.

Please specify 40 or 80 track disc.

CROSSWARE PRODUCTS

Melbourn,
Royston,
Herts. SG8 6BA
Tel: 0763 60838

Seaside listing

From Page 128

```

200 COLOUR8:PRINTTAB(6,6)"2":COLOUR
7:PRINTTAB(9,6)"or":COLOUR15:PRINTTAB
(13,6)"3"
210 COLOUR3:PRINTTAB(1,3)"How many
clouds ?"
220 GCOL0,132
230 CLG
240 VDU5
250 c%=GET-48
260 IFc%=2THEN GOTO310 ELSE GOTO270
270 PROCcloud(15,1000)
280 PROCcloud(50,975)
290 PROCcloud(100,1000)
300 PROCcloud(125,975)
310 PROCcloud(600,1000)
320 PROCcloud(625,950)
330 PROCcloud(550,975)
340 PROCcloud(650,975)
350 PROCcloud(1150,900)
360 PROCcloud(550,975)
370 PROCcloud(650,975)
380 PROCcloud(1150,900)
390 PROCpoint(9,1,15,1)
400 COLOUR3:PRINTTAB(0,3)" What co
lour sea ?"
410 a%=GET
420 GCOL0,a%+48
430 VDU5
440 PROCdraw
450 PROCwave(7,1,1300,685,300)
460 *FX9,100
470 *FX10,100
480 PROCwave(4,1,1050,685,150)
490 PROCwave(11,1050,250,685,75)
500 REM=LIGHTHOUSE
510 GCOL0,7
520 PROCdraw
530 GCOL0,0
540 VDU23,241,60,60,60,60,0,0,0,0
550 VDU23,242,0,0,0,0,60,60,60,60
560 VDU23,243,36,36,36,36,0,0,0,0
570 VDU23,244,0,0,0,0,24,24,60,60
580 VDU23,245,24,24,24,24,0,0,0,0
590 VDU23,246,15,62,252,255,252,255
,62,15
600 VDU23,247,240,124,63,255,63,255
,124,240
610 VDU5
620 GCOL0,0
630 MOVE1155,725
640 VDU241
650 GCOL0,7
660 VDU11,8,242
670 MOVE1155,755
680 VDU241
690 GCOL0,7

```

```

700 VDU11,8,242
710 GCOL0,0
720 MOVE1155,785
730 VDU243
740 GCOL0,7
750 VDU11,8,244
760 GCOL0,11
770 MOVE1155,785
780 VDU245
790 GCOL0,12
800 MOVE1200,793
810 VDU246
820 MOVE1105,793
830 VDU247,4
840 PROCpoint(6,1,18,1)
850 COLOUR3:PRINTTAB(0,3)"What colo
ur cliffs ?"
860 b%=GET
870 GCOL0,b%+48
880 VDU5
890 GCOL0,3
900 PROCdraw
910 GCOL0,b%
920 PROCfill(640,689,150)
930 GCOL0,b%
940 PROCdraw
950 PROCfill(666,779,125)
960 PROCtrees(0,812)
970 PROCtrees(25,812)
980 PROCtrees(75,806)
990 PROCtrees(100,803)
1000 PROCtrees(450,780)
1010 PROCtrees(400,768)
1020 PROCtrees(425,777)
1030 PROCpoint(0,1,3,1)
1040 COLOUR3:PRINTTAB(0,2)"Now the f
irst boat"
1050 PRINTTAB(0,4)"lets paint the hu
ll"
1060 PRINTTAB(0,6)"colour 1 or 2 ?"
1070 c%=GET
1080 GCOL0,c%+48
1090 VDU5
1100 PROCdraw
1110 PROCpoint(12,1,18,1)
1120 COLOUR3:PRINTTAB(0,2)"What colo
ur sails ?"
1130 PRINTTAB(6,4)"5 or 7"
1140 d%=GET
1150 GCOL0,d%-48
1160 GCOL0,3
1170 VDU5
1180 PROCdraw
1190 GCOL0,3
1200 MOVE300,500
1210 DRAW300,970
1220 MOVE300,525
1230 DRAW575,525

```

```

1240 GCOL0,d%
1250 PROCdraw
1260 GCOL0,1
1270 MOVE315,970
1280 MOVE315,955
1290 PLOT 85,365,955
1300 GCOL0,7
1310 MOVE 315,950
1320 MOVE 315,940
1330 PLOT 85,365,950
1340 PROCpoint(0,1,12,1)
1350 COLOUR3:PRINTTAB(3,2)"Now boat
two"
1360 PRINT TAB(3,4)"what colour ?"
1370 e%=GET
1380 VDU5
1390 GCOL0,e%-48
1400 PROCdraw
1410 GCOL0,3
1420 MOVE862,650
1430 DRAW862,800
1440 PROCpoint(0,1,18,1)
1450 COLOUR3:PRINTTAB(0,2)"What colo
ur sails ?"
1460 PRINTTAB(6,4)"1 or 7"
1470 f%=GET
1480 VDU 5
1490 GCOL0,f%-48
1500 MOVE867,660
1510 MOVE960,660
1520 PLOT85,867,792
1530 PROCpoint(0,1,6,1)
1540 COLOUR3:PRINTTAB(0,3)" What co
lour sun"
1550 PRINTTAB(6,5)"1 or 3 ?"
1560 g%=GET
1570 VDU5
1580 GCOL0,g%-48
1590 PROCcircle(1100,950,35)
1600 PROCboy(525,543)
1610 MOVE850,950
1620 VDU 4
1630 CLS
1640 PROCpaint
1650 COLOUR8:PRINTTAB(6,6)"2":COLOUR
7:PRINTTAB(9,6)"or":COLOUR15:PRINTTAB
(13,6)"4"
1660 COLOUR 3:PRINTTAB(3,3)"How many
birds ?"
1670 VDU 5
1680 f%=GET-48
1690 IF f%=2 THEN GOTO 1720 ELSE GOT
O 1700
1700 MOVE900,850
1710 PROCbirds
1720 MOVE50,875

```



CHADDINGTON software for students

BINARY NUMBERS

The program demonstrates and offers practice in the formation of binary numbers, conversion to denary, together with addition, subtraction multiplication and division. Notes included. £10

MATRICES

The formation of matrices from given data, together with their addition, subtraction and multiplication. The use of matrices in transformations and solution of simultaneous linear equations. (O level) Notes included. £10

MULTIPLE CHOICE O LEVEL Mathematics (set 1)

A standard O level syllabus has been split into 10 sections, with 3 random tests of 10 questions on each section. A second disc contains a summary of the syllabus used. £12

MULTIPLE CHOICE O LEVEL mathematics (set 2)

A second set of 300 questions on the same syllabus sections as Set 1. £10

STATISTICS(1) - CHARTS

A set of programs including pie charts, simple bar charts, dual, sectional and monthly bar charts. (O level) Notes included. £10

STATISTICS(2) - FREQUENCY DIAGRAMS

The programs include the production of frequency graphs, histograms and cumulative frequency curves. (O level) Notes included. £10

A CLUSTER OF CURVES (A LEVEL interest)

A set of programs to draw 20 different curves, using polar coordinates, parameters and envelopes of lines and circles. Also sets of confocal conics. Notes included. £10

All notes are provided on strong A4 paper ready for filing. Postage and packing on 1 or more programs 75p

BBC 32K - 40 track discs (or cassette if required)

Electron - cassette

14 SELKIRK CLOSE,
WORTHING BN13 1PR

COMPACT TWIN DISC DRIVES

Cased and uncased 5 1/4" Double Density drives, 40/80 switchable.

Capable of 1.6M (D/Sided) with Double Density DFS, 800K with standard Acorn/Watford/Amcom DFS, including both second processors.

Single sided drives connectable with any other make of single sided drive. (Daisy chain).

Group purchasing of fully guaranteed Data Track Technology Disk units.

Boxed units (matching BBC colour)

Single sided £286.65 Double Sided £351.05

Single Sided with integral power £315.05

Double Sided with integral power £379.80

Unboxed units, Single Sided £262.50

Double Sided £320.00

All prices include VAT and carriage. All boxed units include cables, utility disk and manual. (the BBC Microcomputer Disk Companion)

For details ring:

BALDOCK (0462) 895 405 anytime

SCREEN HANDLER ROM

BBC MICRO MODEL B

(OS 1.0 and later)

- * No more tiresome bottom line entry
- * Create/amend screen formats on screen
- * Full screen data entry in fields
- * Full edit facilities
- * Error highlighting
- * Greatly increases program efficiency
- * Uses no RAM - dramatically reduces program size
- * User program calls ROM based machine code routine to display screen and handle data entry
- * Easy to fit and use - full instructions supplied

£29.95 inc. only from:

MICROSOLVE (BOLTON) LTD.

60 Birches Road, Turton, Bolton BL7 0DX

Tel: 0204 852922

Cash with order or send SAE for full description.

LARGEST COMPUTER CENTRE

in

MANCHESTER

BBC, COMMODORE, MEMOTECH, SINCLAIR,
SHARP, SANYO DEALERS

AMSTRAD IN STOCK

BBC MICRO

BBC B (Free Recorder & Games) £399

Electron £199

6502 Second Processor £199

Z80 Second Processor P.O.A.

Bitstick System £374

DISK DRIVES

Opus, Pace, Cumana

MONITORS

Sanyo 12N £89

Philips £89

Microvitec £229

Microvitec Medium £275

Sanyo Medium £227

Fidelity £217

JVC Medium £199

JVC High £272

PRINTERS

Shinwa CP80 CTI £219

Olivetti JP101 £155

Star Gemini 10X £229

Juki 6100 £388

Epson RX80 FT £289

Cannon 1080 £352

Cosmos 80 £199

Cosmos CP80 £199

National Panasonic £352

Brother HR15 £366

ACCESSORIES

Wordwise £39.95

VIEW £59.95

Grafpad £143.75

Sideways ROM £45

Graphics ROM £33

Disc Doctor £33

Datagen £129.95

COMPUTER STATIONERY, DISKS, PLUGS, SOCKETS, CABLES, ETC.

TELEPHONE ANSWERING MACHINES/CORDLESS PHONES: NOW IN STOCK

Wide range of books, software (educational software specialist).

Showroom, demonstration facility. Prices include VAT, all items

available mail order. Personal Export scheme.

Suppliers to Universities and all leading Schools



MIGHTY MICRO



SHERWOOD CENTRE
268 WILMSLOW ROAD
FALLOWFIELD, MANCHESTER
TEL: 061-224 8117

THE NEXT TRAIN CALLS AT ...

Fulfill a childhood ambition and climb aboard a powerful locomotive as the driver. Your train has a schedule to keep to also as the driver you will have to obey all signals and line speeds. Your performance will be monitored throughout and an end of game score will be displayed provided that you have not been relieved of the controls for endangering passengers lives. Three games to choose from all with a variety of locomotives.

Flying Scotsman - Kings Cross to Doncaster with emphasis on high speed running.

Cornish Riviera - Paddington to Exeter with a stop at Reading.

Master Cutler - The latest in our famous trains series travelling from St. Pancras to Leicester with a fast non stop or semi fast with several stops.

for Commodore 64, BBC 'B' and Spectrum 48K

£7.50 for each game. Available from:

DEE-KAY SYSTEMS. Dept (MU)

18 Salford Close, Woodrow South, Redditch Worcs. B98 7UN.

B J SOFTWARE FOR THE BBC MICRO

HOME ACCOUNTS. Multi-Account System to record & control income & spending of a household, Club or Catalogue Club, with upto 150 2-way accounts, 25 Standing Orders & 15 Special Controlled Accounts. The 11 Page menu includes Calculator, Transaction List, Monthly Profit & Loss Report, etc. etc. Security Coded, well checked & very easy to use. Hard copy available from all 4 Report Pages.

Cassette £6

Disc £8

PROCESS CAPABILITY STUDY. For use by Engineers & Technical Colleges. Based on the Std. Deviation formula, it will take upto 250 readings & report the likely spread of variations of the machine or process against your tolerances. The 12 choice menu allows you to Add, Change readings, Change Tolerances etc. etc. The reports include a Data List, 3 graphs inc. a Frequency Chart. All reports printable.

Cassette £8

Disc £10

Both programs on one Disc £13 (p&p included on all prices)

Cheques to: **B.R.A. Joynes,**

26 Fore Hill Ave. Bessacarr, Doncaster, DN4 7EU.

Seaside listing

From Page 169

```

1730 PROCbirds
1740 VDU4
1750 CLS
1760 CLS
1770 PROCKEY
1780 CLS
1790 VDU23,225,12,12,0,0,12,12,0,0
1800 VDU23,226,12,30,51,97,127,255,2
04,204
1810 VDU23,227,0,0,0,128,128,192,192
,192
1820 VDU23,228,2,3,15,15,2,0,12,12
1830 VDU23,229,0,128,192,128,0,0,0,0
1840 VDU23,230,0,0,12,30,0,0,51,51
1850 VDU5
1860 GCOLOR,0
1870 MOVE850,450
1880 VDU225,8,10,226,227
1890 GCOLOR,3
1900 VDU8,8,11,228,229,10,8,8,230
1910 ENVELOPE1,7,0,0,0,6,3,4,13,-2,0
,-2,75,77
1920 X=TIME+3000
1930 REPEAT
1940 SOUND0,1,RND(3)+3,20
1950 SOUND&1000,0,0,RND(22)+36
1960 UNTIL TIME>=X
1970 VDU4
1980 PROCKEY
1990 MODE 7
2000 PRINT TAB(7,2);CHR$(131);CHR$(1
41);"thank you children"
2010 PRINT TAB(7,3);CHR$(129);CHR$(1
41);"thank you children"
2020 PRINT TAB(8,9);CHR$(131);CHR$(1
41);"for painting me"
2030 PRINT TAB(8,10);CHR$(129);CHR$(
141);"for painting me"
2040 PRINT TAB(7,17);CHR$(131);CHR$(
141);"such a jolly boat"
2050 PRINT TAB(7,18);CHR$(129);CHR$(
141);"such a jolly boat"
2060 PRINT TAB(4,24)"Do you want ano
ther go Y/N "
2070 RESTORE
2080 IF GET$="Y"THEN GOTO 170 ELSE E
ND
2090 DATA4,0,685,4,1300,685,85,0,0,8
5,1300,0,0,0,0,4,1200,685,5,1200,710,
85,1160,685,85,1160,710,85,1145,685,4
,1200,685,4,1200,710,85,1215,685,0,0,
0
2100 DATA4,0,650,5,200,650,5,300,660
,5,500,665,5,700,670,5,950,680,5,1100
,682,5,1300,690,4,0,675,5,300,675,5,9
50,690,0,0,0
2110 DATA4,0,779,5,400,775,5,700,750
,5,705,745,5,711,743,5,715,740,5,720,
725,5,735,723,5,740,719,5,765,713,5,7
80,709,5,802,695,0,0,0
2120 DATA4,200,500,4,575,501,85,200,
425,85,575,425,4,575,425,4,575,500,85
,600,500,4,72,500,4,200,500,85,200,42
5,0,0,0,4,600,515,4,615,515,85,600,42
5,4,615,440,4,635,440,85,615,425,85,6
35,425,4,72,500,5,615,500,0,0,0
2130 DATA 4,315,540,4,315,925,85,555
,540,4,285,525,4,285,875,85,75,525,0,
0,0,4,800,650,5,900,650,85,800,630,85
,900,630,4,800,650,5,800,630,85,777,6
50,0,0,0
2150END
5000 DEF PROCKEY
5010 PRINT TAB(8,23)"Press a key to
go on"
5020 dummy$=GET$
5030 CLS
5040 ENDPROC
5050 DEF PROCpaint
5060 VDU4
5070 CLS
5080 COLOUR1:PRINT TAB(0,0)"1":COLOU
R2:PRINT TAB(3,0)"2":COLOUR3:PRINT TA
B(6,0)"3":COLOUR4:PRINT TAB(9,0)"4":C
OLOUR5:PRINT TAB(12,0)"5":COLOUR6:PRI
NT TAB(15,0)"6":COLOUR7:PRINT TAB(18,
0)"7"
5090ENDPROC
5100 DEF PROCcloud(nx,ny)
5110 MOVEnx,ny
5120 GCOLOR,7
5130 PROCchara
5140 PROCcharb
5150 VDU242,243
5160 VDU8,8,10,244,245
5170 ENDPROC
5180 DEF PROCwave(c,d,mx,my,r)
5190 VDU23,248,0,0,0,0,0,28,56,231
5200 FOR B%=1 TO r
5210 MOVEd+RND(mx),RND(my)
5220 GCOLOR,c
5230 VDU248
5240 NEXTB%
5250 ENDPROC
5260 DEF PROCtrees(qx,qy)
5270 MOVEqx,qy
5280 GCOLOR,2
5290 PROCchara
5300 VDU242,243,242,243
5310 ENDPROC
5320 DEF PROCfill(l,j,wx)
5330 FOR wy=1 TO j
5340 PLOT77,wx,wy
5350 NEXT
5360 ENDPROC
5370 DEF PROCdraw
5380 REPEAT
5390 READ k,y,z
5400 PLOT k,y,z
5410 UNTIL k= 0
5420 ENDPROC
5430 DEF PROCpoint(e,f,g,i)
5440 PROCpaint
5450 COLOUR 8
5460 PRINTTAB(e,f)"^"
5470 COLOUR15
5480 PRINTTAB(g,i)"^"
5490 ENDPROC
5500 DEF PROCcircle(xc,yc,r)
5510 MOVExc+ryc
5520 FOR theta%=2 TO 360 STEP 8
5530 x%=r*COS(RAD(theta%))
5540 y%=r*SIN(RAD(theta%))
5550 MOVExc,yc
5560 PLOT85,xc+x%,yc+y%
5570 NEXT
5580 ENDPROC
5590 DEF PROCboy(xs,ys)
5600 MOVExs,ys
5610 VDU23,251,28,34,34,34,0,0,0,0
5620 VDU23,252,0,28,28,156,136,136,1
95,1
5630 VDU23,253,1,1,0,0,0,0,0,0
5640 VDU23,254,0,0,0,0,0,0,60,60
5650 VDU23,255,60,60,0,0,0,0,0,0
5660 VDU5
5670 GCOLOR,0
5680 VDU251
5690 GCOLOR,7
5700 VDU8,252,10,8,253
5710 GCOLOR,1
5720 VDU8,11,254,10,8,255
5730 ENDPROC
5740 DEF PROCbirds
5750 VDU23,224,0,0,195,36,60,24,0,0
5760 GCOLOR,7
5770 VDU224,9,10,224
5780 ENDPROC
5790 DEF PROCchara
5800 VDU23,242,0,0,0,1,7,15,63,127
5810 VDU23,243,0,0,96,248,252,254,25
5,255
5820 ENDPROC
5830 DEF PROCcharb
5840 VDU23,244,127,127,63,15,7,0,0,0
5850 VDU23,245,255,255,252,252,248,9
6,0,0
5860 ENDPROC
5870 DEF PROCstart
5880 VDU 28,0,31,19,24
5890 CLS
5900 VDU 24,0;265;1279;1023;
5910 ENDPROC

```

This listing is included in this month's cassette tape offer. See order form on Page 213.

Blockbuster listing

From Page 101

```

-32:PROC MAN:PROC MOVE(0,-32):MZ=MZ+1:P
ROCMAN
280 ENDPROC
290 DEFPROC MAN:BCOL3,3
300 IF MZ>225 THEN MZ=224
310 ?&72=MZ:MOVE XZ,YZ:CALL M:ENDPROC

320 DEFPROC GREM:TIX=TIX-5
330 IF TIX MOD 100 =0 THEN PROC SCORE(
TIX,34,16)
340 GX=XZ-32:HYZ=XZ+48:BYZ=YZ+48:H
YZ=YZ-32:BCOL3,2
350 IF XZ<AZ THEN VZ=-ETX ELSE VZ=ETX
360 IF YZ<BZ THEN WZ=-ETX ELSE WZ=ETX
370 PROC CHECK:MOVE AZ,BZ:CALL T:AZ=AZ
+VZ:BZ=BZ+WZ:MOVE AZ,BZ:CALL T:ENDPROC

380 DEFPROC CHECK
390 IF POINT(AZ-4,BZ-16)<>0 THEN VZ=B
400 IF POINT(AZ+32,BZ-16)<>0 THEN VZ=-
B
410 IF POINT(AZ+16,BZ-32)<>0 THEN WZ=B
420 IF POINT(AZ+16,BZ+4)<>0 THEN WZ=-B
430 IF AZ>GX AND AX<HX AND BZ<BYZ AN
DBZ>HYZ AND CVZ<>1 SOUND3,1,84,2:SCZ=SC
Z-10:PROC SCORE(SCZ,34,10)
440 ENDPROC
450 DEFPROC EDGE:MOVE 0,28:DRAW1036,2
B:DRAW1036,1000:DRAW0,1000:DRAW0,32:D
RAW1032,32:DRAW1032,996:DRAW4,996:DRA
W4,32:ENDPROC
460 DEFPROC THINK
470 IF MVZ=1 THEN CX=-32:DX=0:HZ=-4:IX
=0
480 IF MVZ=2 THEN CX=32:DX=0:HZ=36:IX=
0
490 IF MVZ=3 THEN CX=0:DX=32:HZ=0:IX=4
500 IF MVZ=4 THEN CX=0:DX=-32:HZ=0:IX=
-36
510 FX=XZ+CX:GX=YZ+DX
520 IF HITZ=1 AND EEZ=1 THEN PROC SHA
TTER:ENDPROC
530 IF POINT(FX+HZ,GX+IZ)<>0 THEN SO
UNDO,-15,5,1:ENDPROC
540 IF POINT(FZ,GZ)=3 THEN MOVE FZ,G
Z+8:BCOLO,0:PRINT". "
550 PROC TOUCH:PROCTOUCED
560 IF POINT(FZ+CX+HZ,GZ+DX+IZ)<>0
AND BVZ=1 THEN AZ=FX+CX:BZ=GX+DX:BVZ=0:
SOUND0,-15,5,1:ENDPROC
570 IFCVZ<>1 SOUND2,1,200,3
580 REPEAT:PROC SHOVE:UNTIL POINT(FZ
+HZ,GZ+IZ)<>0
590 IF BVZ=1 THEN PROC RESTORE
600 IFCVZ<>1 SOUND2,2,1,2

610 IF POINT(FZ,GZ)=3 THEN PROC CALLS
620 ENDPROC
630 DEFPROC SHOVE
640 IF BVZ=0 THEN PROC GREM ELSE PROC Bump
ped:ENDPROC
650 IFCVZ=1 THEN PROC FANFARE
660 BCOL3,EZ:MOVE FZ,GZ:CALLS:FZ=FX+
CX:GZ=GX+DX:MOVE FZ,GZ:CALLS:PROCTOUCH
:PROCTOUCED:ENDPROC
670 DEFPROC BOX(XXX,YYY):BCOLO,2:MOV
EXXX,YYY:MOVE XXX+156,YYY:PLOT85,XXX+1
56,YYY+156:MOVE XXX,YYY+156:PLOT85,XXX
,YYY:ENDPROC
680 DEFPROC MOVE(XYZ,YYZ)
690 IF POINT(XZ+QZ,YZ+RZ)=2 THEN SOUN
D0,-15,5,1:ENDPROC
700 IF POINT(XZ+QZ,YZ+RZ)=1 THEN EZ
=1:??70=227:EEZ=1:PROC MAN:PROC THINK:P
ROCMAN:ENDPROC
710 IF POINT(XZ+QZ,YZ+RZ)=3 THEN EZ
=3:??70=237:EEZ=0:PROC MAN:PROC THINK:P
ROCMAN:ENDPROC
720 XZ=XZ+XYZ:YZ=YZ+YYZ
730 ENDPROC
740 DEFPROC MEGA:LOCAL LX,YZ:BCOLO,3
:CCZ=0:REPEAT
750 BCOLO,3:CCZ=0:REPEAT
760 XZ=RND(960/32):YZ=RND(928/32)
770 IF POINT(XZ*32+40,YZ*32+64)=0 TH
EN MOVE XZ*32+40,YZ*32+64:VDU237:CCZ=C
CZ+1 ELSE GOTO760
780 UNTIL CCZ=3:ENDPROC
790 DEFPROC SCORE(SCCX,S1Z,S2Z):VDU4
:COLOUR3:PRINTTAB(S1Z,S2Z);SCCX;" "
800 IF SCCX<=0 THEN GOTO820
810 VDU5:ENDPROC
820 *FX15,0
830 FOR LPZ=1 TO 6000:NEXT:VDU5
840 IF PTZ>HI(1) THEN HI(1)=PTZ
850 IF LOPZ=9 THEN VDU4,12,5:GOTO130
860 FZ=XZ:GX=YZ:JIKZ=1:PROC SHATTER:
VDU4:PRINTTAB(12,13);"Game Over"
870 *FX15,0
880 IF INKEY(-99) THEN VDU12,5:GOTO90
890 GOTO880
900 DEFPROC CLINE(TXZ,TYZ,TZ):JJZ=0:
FOR LPZ=TXZ TO TYZ STEP TZ
910 IF POINT(LPZ,GZ)=3 THEN JJZ=JJZ+1:
BCOLO,2:MOVE LPZ,GZ+8:PRINT". "
920 NEXT
930 IF JJZ=3 THEN PROC WIN
940 ENDPROC
950 DEFPROC WIN:LOPZ=9:XZ=328:YZ=320
:MX=224:AZ=648:BZ=512
960 IF DATZ<7 THEN DATZ=DATZ+1 ELSE
DATZ=1:ETZ=16
970 RESTORE 1240:FOR CLZ=1 TO DATZ:RE
AD A,B,C:NEXT:BAZ=BAZ+1

980 IF @X<236 THEN @Z=@Z+1 ELSE @Z=234:
VLZ=2:ETZ=12
990 ?&71=@Z
1000 IF BOPZ<400 THEN BOPZ=BOPZ+50
1010 VDU19,1,9;0;:SOUND1,-15,100,30:
VDU19,2,11;0;:SOUND2,-15,116,30:VDU19
,3,10;0;:SOUND3,-15,148,30:FOR HZ=1 TO1
0000:NEXT:VDU19,1,A;0;19,2,B;0;19,3,C
;0;:REPEAT:TIX=TIX-5:UNTIL TIX MOD 100=0
:OZ=0
1020 FOR LLZ=1 TO TIX STEP 50:PTZ=PTZ+
50:PROC SCORE(PTZ,34,22):TIX=TIX-5:OZ
=OZ+1:SOUND1,3,OZ,1:PROC SCORE(TIX,34,
16):NEXT:SCZ=500:TIX=10000:ENDPROC
1030 DEFPROC CALLS
1040 PROCLINE(FZ-32,FZ+64,32)
1050 PROCLINE(FZ+32,FZ-64,-32)
1060 PROCLINEB(GZ-32,GZ+64,32)
1070 PROCLINEB(GZ+32,GZ-64,-32)
1080 IF JJZ=1 AND SJZ=1 THEN GBCOLO,0:MO
VE FZ,GZ+8:PRINT". "
1090 ENDPROC
1100 DEFPROC CLINEB(SXZ,SYZ,SZ)
1110 SJZ=0
1120 FOR SPZ=SXZ TO SYZ STEP SZ
1130 IF POINT(FZ+4,SPZ)=3 THEN SJZ=SJZ+
1:BCOLO,2:MOVE FZ,SPZ+8:PRINT". "
1140 NEXT
1150 IF SJZ=3 THEN PROC WIN
1160 ENDPROC
1170 DEFPROC FANFARE
1180 READ A,B
1190 IFA=-2 THEN SOUND1,0,0,B/VLZ:SOUN
D2,0,0,B/VLZ:SOUND3,0,0,B/VLZ ELSE SO
UND1,-15,A-100,B/VLZ:SOUND2,-15,A-100
,B/VLZ:SOUND3,-15,A-100,B/VLZ
1200 IF B=16 THEN CVZ=2
1210 ENDPROC
1220 DATA 177,4,169,4,177,4,157,4,141
,4,157,4,129,4,-2,4,177,4,169,4,177,4
,157,4,141,4,157,4,129,4,-2,4,177,4,1
85,4,189,2,-2,2,185,2,189,2,-2,2,189,
2,177,4,185,2,-2,2,177,2,185,2,-2,2,1
85,2,167,4,177,4,161,4,141,4,161,4,17
7,6,-2,2
1230 DATA 169,4,161,4,169,4,157,4,14
1,4,157,4,121,6,-2,2,157,4,149,4,157,
4,141,4,121,4,141,4,109,6,-2,2,157,4,
165,4,169,4,165,4,169,4,157,4,165,4,1
57,4,165,4,149,4,157,16
1240 DATA 5,3,2,1,7,2,4,3,1,1,3,5,2,
7,4,6,3,1,4,6,3
1250 DEFPROC BANG
1260 PROC DOT
1270 E1Z=E1Z+SSZ:E2Z=E2Z-SSZ:F1Z=F1Z
+SSZ:F2Z=F2Z-SSZ:E3Z=E3Z+(2*SSZ):E4Z=

```



£60 WILL ORGANISE YOUR SYSTEM BEAUTIFULLY.

If you have a micro system which is beginning to roam all over the room, Opus can help you to get organised.

For only £59.95 you'll find our purpose built, beautiful teak finished Organiser Desk has plenty of storage space for a complete micro system.

The top shelf has sufficient room for both monitor and printer, while the large desk top area will accommodate your computer, disc drive or cassette recorder and software.

It has castors, making it fully mobile. And the assembled dimensions are H: 31" W: 40¼" D: 26"

Our price includes VAT and free delivery. And the desk comes with simple assembly instructions.

To get your system organised contact us on 01-701 8668 or by posting the coupon to: Opus Supplies Ltd., 158 Camberwell Road, London SE5 0EE. Opening Hours: 9.00 - 5.30pm, Monday - Friday. 9.00 - 1.00pm Saturdays.

To: Opus Supplies Ltd., 158 Camberwell Road, London SE5 0EE.

Please rush me the following:
(PRICES INCLUDE VAT AND CARRIAGE.)

_____ Organiser Desk(s) at £59.95 each (inc VAT)

I enclose a cheque for £ _____ or please debit my credit card account with the amount of £ _____
My Access/Barclaycard (please tick) no. is:

Name _____

Address _____

Telephone _____

Opus.
Opus Supplies Ltd.
BU34

PLAY

your favourite games on the BBC MICRO-COMPUTER

PACK 1

Bandit
Hangman
Lotto

PACK 4

Bingo
Battleships
Rummy

PACK 7

Solitaire
Grand National
Mazes

PACK 10

Fox and Geese
Lazer Chamber
Number Quiz

PACK 2

Poker
Sums
Give and Take

PACK 5

Kiosk
Scissors-paper-stone
Snap

PACK 8

Anagrams
Snake and Ladders
Doodles

PACK 11

Nine Mens Morris
Heads or Tails
Planets

PACK 3

Draughts
O's and X's
Countdown

PACK 6

Roulette
Pontoon
Horoscopes

PACK 9

Ludo
Tiddly-winks
Dice

PACK 12

Tiles
Golf
Word Quiz

Only £10 each pack

Any 5 game selection only £15

Any 10 game selection only £25

MAP-VENTURES

House of Frankenstein	Castle of Dracula	Valley of Dinosaurs
Realm of Atlantis	Pyramid of Tutankhamen	Temple of Zeus
Land of Oz	Maze of the Minator	Complex of Numbers

Amazingly only £5 each

All 9 MAP-VENTURE pack only £30

MILL SOFT

'Humford Mill', Bedlington, Northumberland NE22 5RT

(TAPE - Please state Model A or B; DISC - Please state format)

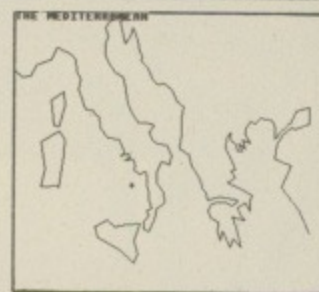
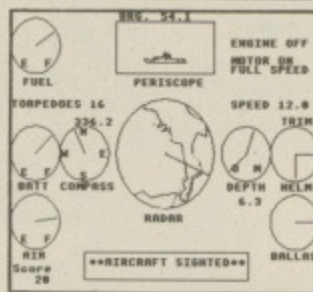

SUBMARINE SIMULATOR

You are in enemy controlled waters. Your mission is to destroy all enemy shipping. Survive aircraft attacks and prolong your stay by hijacking tankers for fuel and torpedoes. Four war zones included. BBC Model B. **Cassette £8.95. Disc 40 or 80 £9.95.**

ANTHONY GAISFORD SOFTWARE
55 Peabworth Road, Harrow Middx. HA1 3UE.

TRITECH MICRO SYSTEMS INTRODUCE "OCTO"

The Professional relay interface for the model B BBC Micro. Octo provides 8 sets of contacts each set rated at 5A (10A resistive) suitable for use at up to 240 V.A.C. Octo is suitable for many varied applications and is ideal for the home robotics enthusiast.

Octo, supplied with Free demo tape comes with 1 year's guarantee and computer cable attached for only £175 inclusive.

Please send cheque or P.O. to:

**Tritech Micro Systems, 38A Station Road,
North Harrow, Middlesex.**

Mail Order Only. Please allow 28 days for delivery.

PRO-SOFT

'OFFICE MANAGER'

An entirely new RANGE OF SOFTWARE written especially for the SMALL BUSINESS using a BBC B COMPUTER, it is based on MODULES which can be used INDEPENDENTLY or INTEGRATED into a full system. The MODULES are, briefly:

1. CUSTOMER/SUPPLIER DATABASE: Name, Address, Phone & Contact Fields with ALPHABETIC SORT & FULL PRINTOUT or NAME/ADD. only for MAILING.

2. SALES LEDGER: INDEXED ENTRY for each CUSTOMER, showing CURRENT BALANCE and full HISTORY of A/C. Prints STATEMENTS with DEBT AGEING. Process, Reconcile, Store & List PAYMENT RECEIVED. Lists SALES.

3. PURCHASE LEDGER: Records CASH/CREDIT PURCHASES. Displays items for PAYMENT and recent PAYMENTS to SUPPLIER. Lists all PURCHASES.

4. VAT RETURN: Prints all SALES and PURCHASES within USER SPECIFIED PERIOD. ANALYSES EXPENDITURE into USER DEFINED CATEGORIES (Graphics Option available). Prints copy of COMPLETED VAT RETURN.

5. APPLICATIONS PACK: SPECIALISED INPUT ROUTINES create TRANSACTION DATABASE from which appropriately formatted INVOICES & CREDIT NOTES can be produced at any time. The system caters for 2 VAT RATES or NO VAT and will support SEVERAL APPLICATIONS ON LINE at one time.

APPLICATION PACKS AVAILABLE NOW: ROAD HAULAGE, SERVICE COs, GENERAL SALES and PLANT & EQUIPMENT HIRE (which includes automatic HIRE UPDATE and COST calculations). Other packs are being prepared but if YOU have a specific requirement please enquire we may be able to help.

The MODULES are available on either 40/80 SS/DS Discs from £25.00 + VAT and are supplied complete with FULL DOCUMENTATION, CONFIGURATION ROUTINE and UTILITIES to ENABLE PRINTING, AMENDING, DELETING and SEARCHING of FILES.

Also available for the Torch Z80, Acorn Z80 & 6502 2nd processors

Send for further details and sample printouts to:

**PRO-SOFT 136, Crosland Road, Oakes,
Huddersfield. W. Yorks.
Tel: 0484 659186**

MARBRY PLANNING LTD

Disc-based STATISTICS PACKAGES for the BBC microcomputer

1) STATISTICS + DATA EDITOR (32K) Disc £10.50

Features: Keyboard/Disc or Tape data input. Arithmetic mean, standard deviation and variance for one or two sets of data, range and frequency tables. Worksheet display. Data display. Data sort. Graph. Bivariate regression: standard error of coefficients, r, F and Durbin-Watson statistics. Data save. Amend single data point. Swap roles of X and Y data. Construct sequential data sets.

2) TIME SERIES ANALYSIS + DATA EDITOR (32K) Disc £34.50

Features: Quarterly Moving Averages. Exponential smoothing. Double exponential smoothing. Adaptive exponential smoothing. Holt-Winters procedure. Graphs of actual versus smoothed data. Amend single data point.

Other titles include: Multiple Regression, Analysis of Variance, Linear Programming.

Order to: **MARBRY PLANNING LTD**
88 Berrylands, Surbiton, Surrey KT5 8JY.

When ordering please state 40/80 track. Please add 50p p&p for each order.

BEAM DESIGN

- For architects, engineers, surveyors, builders, etc.
- Analysis of simply supported beam with any combination of multiple point loads, u.d. loads and triangular loads.
- Steel beam design to BS.449 with selection of suitable single and double sections from standard range of RSJs, Channels, UBs and UCs.
- Timber design to CP.112 permits choice of species/grade and single, double or triple built-up members.
- Allows user to instantly switch between steel and timber modes and browse through the entire range of suitable sections.
- Output to printer for L.A. checking includes all loading data, reactions, max. bending moment, deflection and full details of chosen section(s).
- Separate graphics version displays BM and SF diagrams (but not steel or timber sections).
- Available for BBC model B. Cassette £40, disc £45.

Send large SAE for specification showing printout.

BEAMSCAN, 20 Vaughan Avenue, Hendon, London NW4 4HU.

Blockbuster listing

From Page 172

E4%- (2*SSX)

```

1280 PROCDOT
1290 ENDPROC
1300 DEFPROCSHATTER
1310 GCOL0,2:MOVEFX,6X:VDU231:IF JIK
Z=OTHENPROCGREM
1320 BIJX=150:FORLLZ=231 TO 227 STEP
-1:BIJX=BIJX-8:GCOL0,0:MOVEFX,6X:VDUL
LX:FORLX=1TO300:NEXT:SOUND2,2,BIJX,1:
NEXT
1330 GCOL3,2:SSX=8:E1X=FX+16:F1X=6X-
16:F2X=6X-16:E2X=FX+16:E3X=FX+16:E4X=
FX+16
1340 SOUND0,3,6,5
1350 FORLPX=1TO10:PROCBANG:NEXT:SSX=
4:FORLPX=1TO10:PROCBANG:NEXT
1360 IFJIKX=OTHENSCX=SCX-10:PROCSOR
E(SCX,34,10)
1370 PROCDOT:ENDPROC
1380 DEFPROCDOT
1390 PLOT69,E1X,F1X:PLOT69,E2X,F1X:P
LOT69,FX+16,F1X
1400 PLOT69,E1X,F2X:PLOT69,E2X,F2X:P
LOT69,FX+16,F2X:PLOT69,E3X,6X-16:PLOT
69,E4X,6X-16
1410 ENDPROC
1420 DEFPROCBumped
1430 GCOL3,EX:MOVEFX,6X:CALLS:GCOL3,
2:MOVEFX+CX,6X+DX:CALLT:FX=FX+CX:6X=6
X+DX:GCOL3,EX:MOVEFX,6X:CALLS:GCOL3,2
:MOVEFX+CX,6X+DX:CALLT
1440 FORLPX=0TO30:NEXT:ENDPROC
1450 DEFPROCSTORE:FORLPX=1TO190:NE
XT:GCOL3,EX:MOVEFX,6X:CALLS:MOVEFX+CX
,6X+DX:GCOL3,2:CALLT
1460 IFCX=32THENPROCSQASH(12,0,32,0,
232)
1470 IFCX=-32THENPROCSQASH(-12,0,-20
,0,232)
1480 IFDX=32THENPROCSQASH(0,12,0,20,
233)
1490 IFDX=-32THENPROCSQASH(0,-12,0,-
32,233)
1500 GCOL3,EX:MOVEFX+CX,6X+DX:CALLS
1510 GCOL3,2:AZ=8+(RND(31)*32):BX=51
2:MOVEAX,BX:CALLT:BVX=0
1520 PTX=PTX+100:PROCSORE(PTX,34,22
):SCX=SCX+10:PROCSORE(SCX,34,10)
1530 FX=FX+CX:6X=6X+DX
1540 IFPOINT(FX,6X)=3THEN PROCCALLS
1550 ENDPROC
1560 DEFPROCSQASH(U1X,U2X,U3X,U4X,U5
X)
1570 FX=FX+U1X:6X=6X+U2X
1580 GCOL3,EX:MOVEFX,6X:CALLS
1590 GCOL3,2:MOVEFX+U3X,6X+U4X:VDUUS

```

X

```

1600 FORL=1TO500:NEXT
1610 GCOL3,2:MOVEFX+U3X,6X+U4X:VDUUS
X:GCOL3,EX:MOVEFX,6X:CALLS
1620 FX=FX-U1X:6X=6X-U2X
1630 ENDPROC
1640 DEFPROCTOUCH:AFX=FX-32:AGX=FX+6
4:BFX=6X+32:BGX=6X-64:ENDPROC
1650 DEFPROCTOUCED
1660 IF AX>AFX AND AX<AGX AND BX<BFX
AND BX>BGX THEN BVX=1:GCOL3,2:MOVEAX
,BX:CALLT:MOVEFX+CX,6X+DX:CALLT:HX=HX
+CX:IX=IX+DX:AX=1200:BX=512:SOUND1,4,
1,4:SOUND2,4,16,4:SOUND3,4,48,4
1670 ENDPROC
1680 DEFPROCMC
1690 DIM PROB 50:PX=PROB
1700 [OPTO
1710 .S:LDA&70:JSR&FFEE
1720 RTS
1730 .M:LDA&72:JSR&FFEE:RTS
1740 .T:LDA&71:JSR&FFEE:RTS:]
1750 ENDPROC
1760 *K.0*T.I.MF.IX=0TO TOP-PA. S.4:I
Z!&E00=IX!&1900:N.IMPA.=&E00!MEND!MLO
MEM=TOP!M*FX138,0,129!M
1770 *K.1DELETE1760,2280!M6.50!M
1780 REM.....BLOCKBUSTER.mk7.....
MARK MELFORD ".....
1800 REM.....(C).M.A.Melford.....
1810 MODE7
1820 VDU23;8202;0;0;0;
1830 PROCTITLE(7,1,"B L O C K B U S
T E R")
1840 PRINTTAB(2,5);"KEYS:"
1850 PRINTTAB(9,7)CHR$130;"UP";CHR$
131;".....";CHR$129;"*"
1860 PRINTTAB(9,9)CHR$130;"DOWN";CH
R$131;".....";CHR$129;"?"
1870 PRINTTAB(9,11)CHR$130;"LEFT";C
HR$131;".....";CHR$129;"Z"
1880 PRINTTAB(9,13)CHR$130;"RIGHT";
CHR$131;".....";CHR$129;"X"
1890 PRINTTAB(7,15)CHR$130;"BLAST";
CHR$131;".....";CHR$133;"RETURN"
1900 PROCTITLE(12,22,"M.A.Melford")
1910 *FX9,5
1920 *FX10,5
1930 ENVELOPE1,1,0,-2,-1,6,10,100,86
,0,0,-1,100,0
1940 ENVELOPE2,1,35,-46,23,10,10,10,
126,-1,-1,-70,126,0
1950 ENVELOPE3,1,0,0,0,0,0,100,0,-
1,-1,126,0
1960 ENVELOPE4,1,8,-1,-2,30,50,50,12
6,0,0,-1,126,120
1970 VDU5,19,1,5;0;19,3,2;0;23;8202;
0;0;0;

```

```

1980 VDU19,1,5;0;
1990 VDU23,224,28,42,28,72,127,21,52
,6
2000 VDU23,225,28,42,28,9,127,84,22,
48
2010 VDU23,227,255,195,165,153,153,1
65,195,255
2020 VDU23,228,255,195,165,129,129,1
65,195,255
2030 VDU23,229,255,129,129,129,129,1
29,129,255
2040 VDU23,230,24,0,0,129,129,0,0,24
2050 VDU23,231,0,60,90,102,102,90,60
,0
2060 VDU23,232,32,112,112,168,168,21
6,168,112
2070 VDU23,233,60,86,255,239,86,0,0,
0
2080 VDU23,234,60,126,126,237,201,25
5,213,106
2090 VDU23,235,153,126,90,255,165,21
9,102,60
2100 VDU23,236,102,255,90,66,255,231
,219,126
2110 VDU23,237,231,219,165,66,66,165
,219,231
2120 VDU28,6,20,28,17
2130 RESTORE2280:PROCTUNE
2140 GOTO20
2150 DEFPROCTITLE(A,B,C$)
2160 PRINTTAB(0,B);CHR$(129);CHR$(15
7);" "
2170 PRINTTAB(0,B+1);CHR$(133);CHR$(
157);" "
2180 PRINTTAB(A,B);CHR$131CHR$141;C$
2190 PRINTTAB(A,B+1);CHR$131CHR$141;
C$
2200 ENDPROC
2210 DEFPROCTUNE
2220 FORLPX=1TO35
2230 READA,B
2240 IFA>255THENSOUND2,3,A-300,B*2:6
OTO2260
2250 IFA=-2THENSOUND1,0,A,B*2 ELSE S
OUND1,3,A-45,B*2
2260 NEXT
2270 ENDPROC
2280 DATA197,2,376,6,189,2,185,2,169
,2,368,10,-2,2,169,2,-2,2,364,6,169,2
,189,2,185,2,356,10,169,2,177,10,348,
6,157,2,165,2,169,2,356,10,165,4,169,
2,177,4,360,8,169,8,177,3,368,8,169,3
,161,2,185,2,376,12,177,2,169,2,217,6

```

This listing is included in this month's cassette tape offer. See order form on Page 213.

Teletext listing

From Page 77

```

210 +
220 OPT Q%
230 .START
240 LDA#0
250 STA&7D;PADDING ZERO FOR DEFINIT
ION
260 STA&70;TEXT ADDRESS LD
270 LDA#10
280 STA&71;TEXT ADDRESS HI
290 LDA&83;GET SCREEN X,Y POS
300 STA&81
310 LDA&7C;CALCULATE ADDRESS
320 STA&82
330 LDY&84
340 .NXADD
350 DEY
360 BMI ADDRDONE
370 LDA&81
380 CLC
390 ADC#40
400 STA&81
410 BCC NCARRY
420 INC&82
430 .NCARRY
440 JMP NXADD
450 .ADDRDONE
460 LDY#0
470 LDA&7E
480 STA(&81),Y
490 LDY#40
500 STA(&81),Y
510 LDY#80
520 STA(&81),Y
530 INC&81
540 BNE NCARRY2
550 INC&82
560 .NCARRY2
570 LDA&7F
580 BEQ NSEPARTED
590 LDY#0
600 LDA#154
610 STA(&81),Y
620 LDY#40
630 STA(&81),Y
640 LDY#80
650 STA(&81),Y
660 INC&81
670 BNE NCARRY3
680 INC&82
690 .NCARRY3
700 .NSEPARTED

710 LDA#255
720 STA&72
730 .NXLTER
740 LDA#&C0
750 STA&85;RESET FLAG
760 INC&72
770 LDY&72
780 LDA(&70),Y;GET LETTER
790 BPL LEAVEFLAG
800 LDX#&9
810 STX&85
820 .LEAVEFLAG
830 CMP#13;FINISHED ?
840 BNE NTEND
850 RTS
860 .NTEND
870 SEC
880 SBC#32
890 LDX#0
900 STX&74
910 ASL A;CALCULATE ROM CHAR ADDRES
S
920 ROL&74
930 ASL A
940 ROL&74
950 ASL A
960 ROL&74
970 STA&73
980 LDA&85
990 CLC
1000 ADC&74
1010 STA&74
1020 LDY#7
1030 .NXROW
1040 LDA(&73),Y
1050 STA&75,Y
1060 DEY
1070 BPL NXROW
1080 LDX#0;TOP ROW
1090 LDY#0
1100 .NXROW1
1110 LDA#4
1120 STA&80
1130 .NXBLOCK
1140 ASL&75,X
1150 ROR A
1160 ASL&75,X
1170 ROR A
1180 ASL&76,X
1190 ROR A
1200 ASL&76,X
1210 ROR A
1220 ASL&77,X
1230 ROR A

1240 LSR A
1250 ASL&77,X
1260 ROR A
1270 LSR A
1280 CLC
1290 ADC#160
1300 STA(&81),Y
1310 INY
1320 DEC&80
1330 BNE NXBLOCK
1340 TYA
1350 CLC
1360 ADC#36;DOWN A ROW
1370 TAY
1380 INX
1390 INX
1400 INX
1410 CPX#9
1420 BNE NXROW1
1430 LDA&81
1440 CLC
1450 ADC#4;ACROSS 1 LETTER
1460 STA&81
1470 BCC NCARRY1
1480 INC&82
1490 .NCARRY1
1500 JMP NXLTER
1510 +
1520 NEXT
1530 FOR X%=0 TO 18 STEP 3
1540 PROCprint(X% MOD 7+1,X% AND 1,X
%,X%,"BBC")
1550 NEXT
1560 VDU 23,128,28,28,8,127,8,20,34,
65
1570 PROCprint(6,0,0,18,"Me:"+CHR$(1
28))
1580 PROCprint(2,1,13,0,"Me:"+CHR$(1
28))
1590 PRINT TAB(0,23);
1600 REPEAT UNTIL FALSE
1610 REM
1620 DEF PROCprint(C%,S%,X%,Y%,M%)
1630 ?&7E=C%+144
1640 ?&7F=S%
1650 ?&83=X%
1660 ?&84=Y%
1670 $&A00=M%
1680 CALL &900
1690 ENDPROC

```

This listing is included in this month's cassette tape offer. See order form on Page 213.



Leigh Computer Systems

NEVER BEATEN ON PRICE!



CUMANA DISC DRIVES

	Inc VAT £	Ex VAT £
CSX 100	127.00	110.45
CSX 200	145.00	125.72
CSX 200D	158.00	137.47
CSX 400	189.00	164.50
CS 100	151.00	131.60
CS 200	162.00	141.00
CS 400	213.00	185.65
CS 100E	138.00	119.85
CS 200E	149.00	129.25
CS 400E	200.00	173.90
CS 200ED	162.00	141.00
CD 200	276.00	240.00
CD 400	298.00	259.67
CD 400D	324.00	282.00
CD 800	394.00	343.10
CD 400/S	370.00	321.95
CD 800/S	469.00	407.72
Note: CSX drives do not have power supply.		
DFS KIT	95.00	82.60

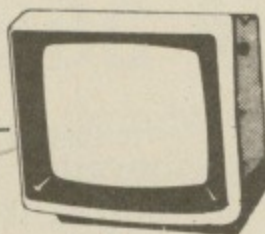

MONITORS

	Inc VAT £	Ex VAT £
MICROVITEC CUB 1431 14" TTL (BBC, Electron, Oric, 48oz compatible)	199.00	173.04
MICROVITEC CUB1451 14" TTL (BBC, Electron, Oric, 48oz compatible)	299.00	260.00
MICROVITEC CUB 1441 14" TTL (BBC, Electron, Oric, 48oz compatible)	415.00	360.87
QL MONITOR	275.00	239.13
TV/MONITOR (Manual)	225.00	195.65
TV/MONITOR (Remote)	245.00	213.04

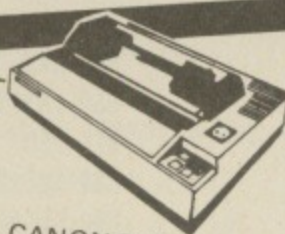

PRINTERS

	Inc VAT £	Ex VAT £
CANON PW 1080 A (Colour)	431.25	375.00
CANON PW 1080 A	309.00	269.00
EPSON RX 80	218.50	189.95
EPSON RX 80 F/T	245.00	213.00
EPSON FX 80	373.75	325.00
EPSON MX 100	420.00	366.00
EPSON FX 100	487.50	424.00
EPSON DX 100 (Daisywheel)	408.25	355.00
JUKI 6100 (Daisywheel)	373.75	325.00
KAGA TAXAN		P.O.A.
PRINTER LEADS	9.75	8.50
+ Many other makes at competitive prices.		

ROMS

	Inc VAT £	Ex VAT £
WORDWISE	36.80	32.00
VIEW	59.95	50.95
GRAPHICS ROM	31.00	26.35
DISC DOCTOR	31.00	26.35
GEMLIN	31.00	26.35
PRINT MASTER	31.00	26.35
CARETAKER	31.00	26.35

Special November Price

2764 EPROMS	5.75	5.00
27128 EPROMS	17.25	15.00

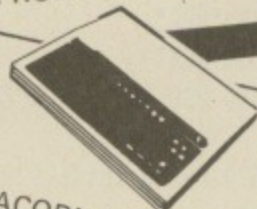

COMPUTERS

	Inc VAT £	Ex VAT £
ACORN ELECTRON	199.00	173.00
BBC B	399.00	346.90
BBC B with DFS	469.00	408.00
TATUNG EINSTEIN	499.00	424.15
SANYO 555	999.00	849.15

PERIPHERALS

	Inc VAT £	Ex VAT £
QUICKSHOT I JOYSTICK	8.25	7.01
QUICKSHOT II JOYSTICK	9.25	7.86
CRACKSHOT	7.25	6.16
SURESHOT	16.00	13.60
PAIR OF LVL JOYSTICKS	19.95	16.95
PRO-LINK INTERFACE	9.95	8.45
C12 BLANK TAPES	40	34
SPECTRUM INTERFACE II	19.95	16.95
TEAK MONITOR STAND	10.35	9.00
BULLDOG COMPUTER TROLLEYS		
At competitive prices (ideal for schools, etc).		

EDUCATIONAL ORDERS SUPPLIED

- Price list available on application

**7 COVENTRY ROAD
HINCKLEY
LEICS.
Telephone: 0455 612139**

NEW SHOWROOM OPEN!
75 Cross Street
Sale
Manchester
Tel: 061-905 2144

THE BEEB BODY BUILDING COURSE

From Page 109

Listing I

```

10 MODE4
20 PRINT"BEEB BODY BUILDING COURSE
No. 20"
30 PRINT"Sound synthesiser using D
/A converter"
40 PRINT"By Mike Cook"
50 NX=32
60 HIMEM=HIMEM-(NX*256+200)
70 DIM COX(7,31), ANOTEX 65, CLIX
27
80 PROC_INCODE
90 PROC_NINT
100 PROC_COFLS(0)
110 REPEAT
120 PROC_INS
130 C$=GET$
140 IF C$="V" THEN PROC_WLOOK
150 IF C$="D" THEN PROC_WSETUP
160 IF C$="C" THEN PROC_TCALC
170 IF C$="P" THEN PROC_PLAY
180 IF C$="L" THEN PROC_LOAD
190 IF C$="S" THEN PROC_SAVE
200 IF C$="H" THEN PROC_HAR
210 UNTIL FALSE
220 DEF PROC_INCODE
230 ?&FE62=&FF :REM VIA OUTPUTS
240 ?&FE6B=&40 :REM TIMER MODES
250 ?&78=NX
260 FOR AX=0 TO 2 STEP 2
270 PX=HIMEM+1
280 [
290 OPT AX
300 .SYNTH
310 LDX &78
320 LDA &79
330 STA &72
340 LDA &7A
350 STA &73
360 SEI
370 LDA #&E0
380 STA &FE6E
390 LDA #50
400 STA &FE64
410 STA &FE66
420 LDA #0
430 STA &FE67
440 STA &FE65
450 .ST2 LDA #&FF
460 STA &FE68
470 LDA &76
480 STA &FE69
490 .HOLD LDA #&40
500 .HOLD2 BIT &FE6D
510 BEQ HOLD2
520 STA &FE6D
530 CLC
540 LDA &74
550 ADC &70
560 STA &70
570 LDA &75
580 ADC &71
590 STA &71
600 LDY &71
610 LDA (&72),Y
620 STA &FE60
630 LDA #&20
640 BIT &FE6D
650 BEQ HOLD
660 STA &FE6D
670 INC &73
680 DEX
690 BNE ST2
700 LDA #&60
710 STA &FE6E
720 LDA #128
730 STA &FE60
740 CLI
750 RTS
760 NOP
770 .TSTART
780 ]
790 NEXT
800 ?&79=TSTART MOD 256
810 ?&7A=TSTART DIV 256
820 ENDPROC
830 DEF PROC_NINT
840 LOCAL F,FI,R
850 FOR CX=1 TO 4
860 RESTORE 1000
870 FOR AX=ANOTEX+(CX-1)*14 TO ANOT
EX+(CX-1)*14+12 STEP 2
880 READ F
890 IF CX<>2 THEN F=F*2^(CX-2)
900 FI=F*256*50E-6
910 ?AX=INT(FI)
920 TX=0
930 R=FI-INT(FI)
940 FOR BX=1 TO 8
950 IF R>2^-BX THEN R=R-2^-BX:TX=TX
+2^(8-BX)
960 NEXT
970 AX?1=TX
980 NEXT
990 NEXT
1000 DATA 261.6256,293.6648,329.6276
1010 DATA 349.2282,391.9954,440.000
1020 DATA 493.8833,523.2511
1030 ENDPROC
1040 DEF PROC_PLAY
1050 CLS
1060 PRINT TAB(0,11);"RETURN key to
end"
1070 ?&76=&10
1080 REPEAT
1090 XZ=GET
1100 KZ=2+(XZ AND 31)
1110 ?&74=ANOTEX?(KZ+1)
1120 ?&75=ANOTEX?KZ
1130 CALL SYNTH
1140 UNTIL XZ=13
1150 ENDPROC
1160 DEF PROC_WDISPLAY
1170 FOR HZ=0 TO NHARZ-1
1180 PROC_HDISPLAY
1190 NEXT
1200 ENDPROC
1210 DEF PROC_HDISPLAY
1220 MOVE 156,1024
1230 DRAW 156,508
1240 DRAW 935,508
1250 SX=0
1260 UZ=31
1270 PROC_DISPART
1280 ENDPROC
1290 DEF PROC_WSETUP
1300 LZ=144
1310 RX=344
1320 AX=0
1330 PRINT TAB(0,23);"9 To view all"
1340 PRINT
1350 PRINT"0 To return to menu"
1360 PRINT
1370 PRINT "HARMONIC TO VIEW (1-";N
HARZ;" )?";
1380 HZ=GET AND 15
1390 IF HZ<>9 AND HZ>NHARZ THEN 1370
1400 HZ=HZ-1
1410 CLS
1420 IF HZ<0 THEN PROC_COFLS(1):ENDP
ROC
1430 IF HZ>7 THEN PRINT TAB(0,17);"H
EARS THE LOT THEN" : PROC_WDISPLAY :
GOTO 1370
1440 PROC_HDISPLAY
1450 PRINTTAB(0,19);"Use cursor keys
to draw HARMONIC No. ";HZ+1
1460 PRINT"SPACE BAR alternates arro
ws"
1470 PRINT"SHIFT held down increases

```

WE LOVE YOUR ACORN TOO

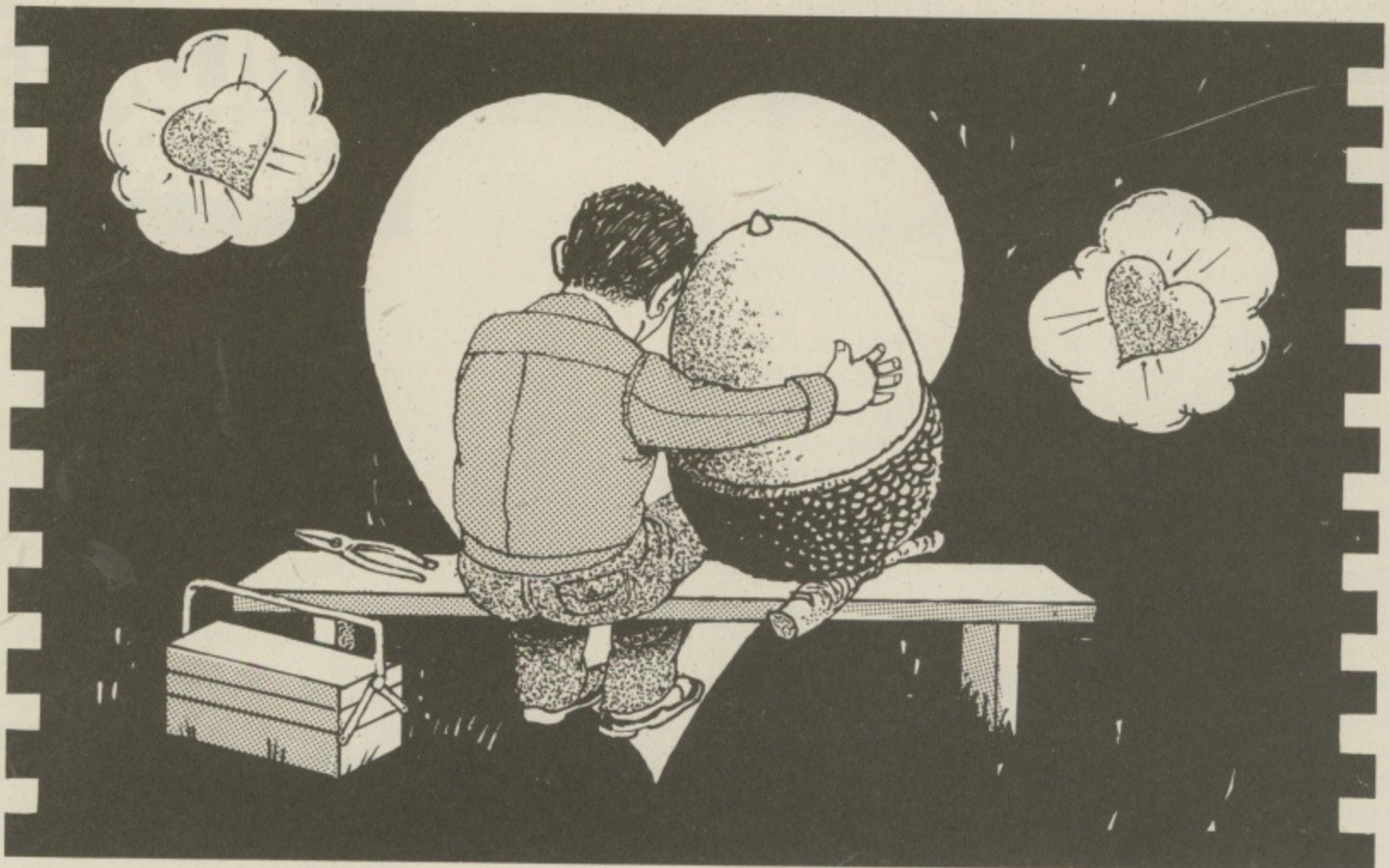

RCS Computer Services are the main service centre for the Acorn Computer, it is fully equipped to undertake a comprehensive range of services.

★ WARRANTY/GUARANTEE ★

If your computer (BBC or Electron), B/W Monitor, cassette recorder or disk drive as supplied by Acorn becomes defective within the warranty period, RCS Computer Services are authorised to carry out the repair and return the equipment free of charge. All charges in this connection being paid by Acorn Computers.

★ EXTENDED GUARANTEE/ANNUAL MAINTENANCE CONTRACTS ★

The experience of RCS Computer Services allows us to offer a comprehensive guarantee extension or annual maintenance contracts at competitive prices, this applies not only to the standard Acorn product but also to a range of approved peripherals including printers, colour monitors etc.

★ UPGRADES ★

Supply and installation of upgrades such as DFS, Econet, Teletext etc. can be carried out quickly, efficiently and professionally by trained staff at our Service Centre.

★ SYSTEM INSTALLATION ★

Supply and installation of Econet Systems can be arranged and fully commissioned.

RCS

COMPUTER SERVICES

Enterprise House
Central Way
North Feltham Trading Estate
Feltham, Middlesex TW14 0RX
Tel: 01-844 1333/1200. Tlx: 916581 LDATA

From Page 179

```

step size"
1480 PRINT"RETURN to view a new harm
onic"
1490 *FX4,1
1500 VDU 5
1510 MOVE LX,480:PRINT CHR$94
1520 MOVE RX,480:PRINT CHR$94
1530 PROC_AUPD
1540 REPEAT
1550 *FX15,0
1560 A$=GET$
1570 BX=ASC(A$)
1580 IF A$=" " THEN PROC_AUPD:AX=AX
FOR 1:PROC_MARROW(AX,0)
1590 IF BX=136 OR BX=137 THEN PROC_M
ARROW(AX,BX)
1600 IF BX=138 OR BX=139 THEN PROC_A
DJUST
1610 UNTIL BX=13
1620 *FX4,0
1630 VDU4
1640 GOTO 1330
1650 ENDPROC
1660 DEF PROC_MARROW(AX,BX)
1670 IF BX=136 THEN BX=-25
1680 IF BX=137 THEN BX=25
1690 GCOL 3,1
1700 IF AX THEN MOVE LX,480 :LX=LX+B
X ELSE MOVE RX,480:RX=RX+BX
1710 IF BX<>0 THEN VDU95,8,94
1720 GCOL 0,1
1730 IF LX<144 OR LX>919 THEN LX=LX-
BX
1740 IF RX<144 OR RX>919 THEN RX=RX-
BX
1750 MOVE LX,480:PRINTCHR$94
1760 MOVE RX,480:PRINTCHR$94
1770 PROC_AUPD
1780 ENDPROC
1790 DEF PROC_AUPD
1800 GCOL 3,1
1810 IF AX THEN MOVE LX,480 ELSE MOV
E RX,480
1820 PRINT CHR$95
1830 GCOL 0,1
1840 ENDPROC
1850 DEF PROC_ADJUST
1860 IF RX=LX THEN ENDPROC
1870 SX=(RX-144)/25
1880 UX=(LX-144)/25
1890 IF AX THEN ZX=UX ELSE ZX=SX
1900 IF SX>UX THEN TX=SX:SX=UX:UX=TX
1910 GCOL 0,0
1920 PROC_DISPART

```

```

1930 GCOL 0,1
1940 IF BX=139 THEN BX=4 ELSE BX=-4
1950 IF INKEY(-1) THEN BX=BX*8
1960 COZ(HX,ZX)=COZ(HX,ZX)+BX
1970 IF COZ(HX,ZX)>255 OR COZ(HX,ZX)
<0 THEN COZ(HX,ZX)=COZ(HX,ZX)-BX
1980 TX=0
1990 D=(COZ(HX,UX)-COZ(HX,SX))/ABS(U
X-SX)
2000 FOR WX=SX TO UX
2010 COZ(HX,WX)=COZ(HX,SX)+D*TX
2020 TX=TX+1
2030 NEXT
2040 PROC_DISPART
2050 ENDPROC
2060 DEF PROC_DISPART
2070 IF SX<>0 THEN FX=SX-1 ELSE FX=S
X
2080 IF UX<>31 THEN TX=UX+1 ELSE TX=
UX
2090 FOR DX=FX TO TX
2100 XZ=160+DX*25
2110 YZ=COZ(HX,DX)*2+512
2120 IF DX=FX THEN MOVE XZ,YZ ELSE D
RAW XZ,YZ
2130 NEXT
2140 ENDPROC
2150 DEF PROC_COZ(DX)
2160 AX=TSTART+NX*256
2170 IF DX=1 THEN ?AX=NHARZ ELSE NHA
RX=?AX
2180 AX=AX+1
2190 FOR WX=0 TO 31
2200 FOR HX=0 TO 7
2210 IF DX=1 THEN ?AX=COZ(HX,WX) ELS
E COZ(HX,WX)=?AX
2220 AX=AX+1
2230 NEXT
2240 NEXT
2250 ENDPROC
2260 DEF PROC_TCALC
2270 CLS
2280 PRINT TAB(0,10);"This will take
some time"
2290 PRINT"First, calculating the sc
aling factor"
2300 PRINT"For all ";NX;" tables"
2310 PRINT"Working on: -"
2320 MAX=0
2330 HPI=PI/2
2340 FOR TX=0 TO NX-1
2350 PRINT TAB(0,14);"Table No. ";TX+
1
2360 FOR HX=1 TO 8
2370 FOR PX=0 TO HX/2
2380 F=HPI/HX+(2*PI*PX)/HX

```

THE BEEB BODY BUILDING COURSE

```

2390 CVAL=0
2400 FOR BX=0 TO NHARZ-1
2410 CVAL=CVAL+COZ(BX,TX)*SIN(F+(BX+
1))
2420 NEXT
2430 IF CVAL>MAX THEN MAX=CVAL
2440 NEXT
2450 NEXT
2460 NEXT
2470 PRINT
2480 MAX=MAX+4
2490 PRINT"NOW calculating the table
s"
2500 PRINT
2510 PRINT"This will take about ";NH
ARZ*4;" Mins"
2520 SF=127/MAX
2530 AX=TSTART
2540 FOR TX=0 TO NX-1
2550 PRINT TAB(0,19);"Table No. ";TX+
1
2560 FOR F=0 TO 2*PI STEP 2*PI/255
2570 CVAL=0
2580 FOR BX=0 TO NHARZ-1
2590 CVAL=CVAL+COZ(BX,TX)*SIN(F+(BX+
1))
2600 NEXT
2610 ?AX=127+SF+CVAL
2620 AX=AX+1
2630 NEXT
2640 NEXT
2650 SOUND 1,-15,65,12
2660 ENDPROC
2670 DEF PROC_WLOOK
2680 CLS
2690 PRINT"WAVEFORM PLOTTER"
2700 PRINT TAB(0,8);"SPACE BAR for n
ext waveform"
2710 PRINT"B - key for BACK"
2720 PRINT"RETURN - to end"
2730 AX=GET
2740 IF AX=13 THEN ENDPROC
2750 AX=TSTART
2760 TX=0
2770 REPEAT
2780 CLS

```

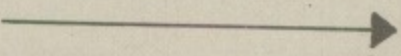

FREE INTERFACE

With every **brother** typewriter models CE51, 60, 70, EM80, 100, 200 purchased

Available to BBC B users only

This unique interface, incorporating its own view driver, will enable you to use the brother typewriters as letter quality printers. Its easy to install and comes complete with full documentation.

COMPARE THIS PRICE FOR A LETTER QUALITY PRINTER

CE51 **£299 +VAT**

OR

Purchase the interface only for £75 incl VAT.

Barclay-Access and credit facilities available.

Send SAE for further details.

ABACUS BUSINESS MACHINES LTD

961 Christchurch Road, Bournemouth,

Dorset BH7 6AZ. Tel: (0202) 423204

TRADE ENQUIRIES WELCOME

Ephagy Software Products Present

Disc-Minder Service: We offer to protect disc based BBC computer software to make it inaccessible to disc sector editors and back-up/copying utility programs. Write now for further information.

Copyrite:

Disc
Back-up
Utility

WARNING This powerful package is not intended to be used to break copyright. It is capable of duplicating most protected disc based software and as such must be used with discretion.

Copyrite and other products protected by Disc-Minder cannot be recreated using this program.

(Disc) Price **£10.95**

Micro-Phile A direct access data base and report generator - suitable for use in Education, data collection, personal records etc. Write for full specification.

(Disc) Price **£14.95**

Texprint: True model 7 dump utility. Includes instructions to merge with a teletext editor.

(Disc) Price **£8.95**

GAMES: [Cassette only]

Fruity, Fruity - Fruit Machine with nudge. **£5.95**

Stuka! Defend cities from dive bomber. **£5.95**

EDUCATIONAL: Missing Words: (Cass) (Disc)

Primary English Pack - Word Swap **£9.95/£10.95**

Primary Activity Pack - Music Writer: **£9.95/£10.95**

Picture Draw **£9.95/£10.95**

Ephagy Software Products.

125 Corporation Road, Grimsby, S. Humberside. DN31 1UR.

The SOURCE

THAT'S WHERE TO GET IT!

SERIOUS SOFTWARE SOURCE CATALOGUE

Software to do a job - not to play with! Our new catalogue not only lists but gives a description of each program. Business, Education, Scientific, Engineering, Radio Computing, Statistics and many other subjects. **FREE**

BOOK SOURCE CATALOGUE

From Artificial Intelligence to Xenix! If you need to know more about almost any subject to do with Computing then this is for you. Perhaps the most comprehensive specialist book catalogue ever compiled. **FREE**

C/PM & MS-DOS SOURCE CATALOGUE

A range of professional software from some of the worlds most experienced software houses, for the new operating systems now available on the BBC B.

A description is given of each program. **FREE**

GIFT VOUCHER SERVICE

Do you know exactly what to buy as a gift? Why not give one of our Gift Vouchers? - Vouchers start at just £10 - then they can choose their own gift from any of our comprehensive catalogues!

Send your name, address and requirement, plus £1 (to cover postage) - For your free catalogue.

The Computer Mail Order People

David Winrow Marketing, Unit , PO BOX 9,
Northwich, Cheshire CW9 7TP.

ULTRACALC

Upgraded version now available!

Ultracalc, the successful spreadsheet program from BBC Publications, has now been upgraded to increase its power and flexibility.

New features include:

- Operation in any screen mode
- Greater printer flexibility including control codes and £ sign definition
- Runs as 'HICALC' on a 6502 second processor to allow 44k of workspace in any screen mode
- Spooling of ASCII text files for subsequent use with any word processor
- Several additional layout options
- Supplementary manual containing a wealth of information on how to use Ultracalc.

£79.50 (inc. VAT)

If you already have a copy of the original Ultracalc, you can exchange it for the new version for just £6.25 inclusive of VAT, postage and packing.

Contact your local dealer or write to Software Editor, BBC Publications, 35 Marylebone High Street, London W1M 4AA, enclosing a stamped addressed envelope.



THE BEEB BODY BUILDING COURSE

From Page 181

```

2790 PRINT TAB(0,0);"WAVEFORM TABLE
No.";TX+1
2800 MOVE 0,?AZ*4
2810 AZ=AZ+1
2820 FOR XZ=4 TO 1023 STEP 4
2830 DRAW XX,?AZ*4
2840 AZ=AZ+1
2850 NEXT
2860 XZ=GET
2870 IF XZ<>42 THEN TX=TX+1 ELSE TX
=TX-1:AZ=AZ-512
2880 IF TX<0 OR TX>(NZ-1) THEN TX=0
2890 IF TX=0 THEN AZ=TSTART
2900 UNTIL XZ=13
2910 ENDPROC
2920 DEF PROC_SAVE
2930 PROC_CDFLS(1)
2940 PROC_NAME("SAVE the table in")
2950 $CLIX="SAVE T."+"F$+" 3600 5800"
2960 PROC_IMPLEMENT
2970 ENDPROC
2980 DEF PROC_LOAD
2990 PROC_NAME("LOAD the table from"
)
3000 $CLIX="LOAD T."+"F$
3010 ON ERROR GOTO 3060
3020 PROC_IMPLEMENT
3030 ON ERROR OFF
3040 PROC_CDFLS(0)
3050 ENDPROC
3060 REPORT
3070 TIME=0
3080 REPEAT:UNTIL TIME>300
3090 RUN
3100 DEF PROC_NAME(A$)
3110 CLS
3120 PRINT TAB(0,8);"WAVEFORM TABLE
STORAGE"
3130 PRINT"Input file name to ";A$
3140 INPUT F$
3150 ENDPROC
3160 DEF PROC_IMPLEMENT
3170 XZ=CLIX MOD 256
3180 YZ=CLIX DIV 256
3190 CALL &FFF7
3200 ENDPROC
3210 DEF PROC_HAR
3220 REPEAT
3230 INPUT"NUMBER OF HARMONICS TO US
E 1-8 ",NHARZ
3240 UNTIL NHARZ<9 AND NHARZ>0
3250 ?(TSTART+NZ*256)=NHARZ

```

```

3260 ENDPROC
3270 DEF PROC_INS
3280 CLS
3290 PRINT"SOUND SYNTHESISER"
3300 PRINT"Using ";NHARZ;" harmonics
"
3310 PRINT
3320 PRINT
3330 PRINT"D - DRAW the harmonic en
velopes"
3340 PRINT"C - CALCULATE the wavefor
ms"
3350 PRINT"V - VIEW the waveforms in
the table"
3360 PRINT"P - PLAY the notes from t
he keyboard"
3370 PRINT"H - Change the number of
HARMONICS used"
3380 PRINT"S - SAVE the waveform tab
les"
3390 PRINT"L - LOAD the waveform tab
les"
3400 PRINT
3410 PRINT"Make your choice"
3420 ENDPROC

```

Listing II

```

10 MODE4
20 PRINTTAB(0,4);"BEEB BODY BUILDI
NG COURSE No. 20"
30 PRINT"Sound synthesiser using D
/A converter"
40 PRINT"TUNE PLAYER"
50 PRINT"By Mike Cook"
60 PRINT
70 PRINT"Load in waveform tables a
nd then play"
80 NZ=32
90 HIMEM=HIMEM-(NZ*256+200)
100 DIM ANDTEX 96, CLIX 27
110 octave$="cCdDefGgAaBb":REM CAPS
=# (C=c sharp)
120 PROC_INCODE
130 PROC_NINT
140 REPEAT
150 PROC_INS
160 C$=GET$
170 IF C$="P" THEN PROC_PLAY
180 IF C$="L" THEN PROC_LOAD
190 IF C$="T" THEN PROC_TUNE
200 UNTIL FALSE
210 DEF PROC_INCODE
220 REM INITIALISE MACHINE CODE SEC

```

TION

```

230 ?&FE62=&FF :REM VIA OUTPUTS
240 ?&FE6B=&40 :REM TIMER MODES
250 ?&78=NZ
260 FOR AZ=0 TO 2 STEP 2
270 PZ=HIMEM+1
280 [
290 OPT AZ
300 .SYNTH \ SYNTHESISE A NOTE
310 LDX &78 \ SET UP NUMBER OF TABL
ES TO USE
320 LDA &79 \ SET UP ADDRESS OF
330 STA &72 \ START OF WAVEFORM TAB
LES
340 LDA &7A
350 STA &73
360 SEI \ DISABLE INTERRUPTS FROM T
HE SYSTEM
370 LDA #&E0 \ ENABLE THE TWO TIMER
S
380 STA &FE6E
390 LDA #50 \ INITIALISE T1
400 STA &FE64 \ LOW ORDER COUNT
410 STA &FE66 \ LOW ORDER LATCH
420 LDA #0
430 STA &FE67 \ HIGH ORDER LATCH
440 STA &FE65 \ START T1 RUNNING
450 .ST2 \ START T2
460 LDA #&FF
470 STA &FE68
480 LDA &76 \ VALUE FROM MEMORY
490 STA &FE69
500 .HOLD \ LOOP UNTIL T1 TIMEOUT
510 LDA #&40
520 .HOLD2 BIT &FE6D \ SEE IF T1 IS
READY
530 BEQ HOLD2
540 STA &FE6D \CLEAR INTERRUPT FLAG
550 \ MOVE ON THE ENTRY POINTER
560 CLC
570 LDA &74 \ INCREMENT VALUE
580 ADC &70
590 STA &70
600 LDA &75
610 ADC &71

```

Authorised Dealer & Service Centre
IN
MID-SUSSEX



BBC
MICRO COMPUTER



- **HARDWARE** BBC B's, Electron & wide range of Monitors, Printers, Disc Drives & Watford Kits
- **SERVICING/UPGRADING** On site Engineering
- **SOFTWARE** Variety of Educational Games/Business Packages
- **COURSES** Beginners & upwards on BBC Micro from £20. Day/Evening. Children/Adults

PHONE
BURGESS HILL
(04446)
45636

Over 400 items on our price list

michael
Business Systems Ltd
195 LONDON ROAD BURGESS HILL SUSSEX



Proudly presents
CHESS ANALYSIS SYSTEM (CAS)

CHESS DATABASE for the BBC Model B (OS 1.2)

- EASY TO USE structured database.
- MOVES, VARIATIONS AND COMMENTS in a file.
- ANY NUMBER OF GAMES in a file.
- START GAMES from any position.
- MANY REPLAY OPTIONS include: AUTOMATIC RESET to selected position; JUMP backwards and forwards in a game; TEST YOURSELF against the data file.
- LARGE DISPLAY of board and pieces showing current position.
- You can use CAS to: BUILD AND UPDATE your personal opening system; RECORD AND ANALYSE games including POSTAL CHESS games with dates; ANALYSE POSITIONS, e.g. analyse variations on adjourned games.

In addition Compuchess provides data files containing instructional and reference material for use with CAS. Many more will follow.

CHESS AUTHORS We are seeking chess material suitable for publication in data files. No programming knowledge is needed! We are also seeking a strong machine code chess playing program. Excellent royalties will be offered.

ALL GOODS DESPATCHED WITHIN 5 WORKING DAYS. PLEASE SEND ORDER & CHEQUE/P.O. TO **COMPUCHESS, Horndale Avenue, Aycliffe Industrial Estate, Co. Durham DL5 6DR.** Tel: (091) 2854325. Educational & dealer enquiries welcome. VAT No. 257 8710 30.

Name _____ Cheque/P.O. for _____

Address _____

Post code _____

Please tick boxes as appropriate

CHESS ANALYSIS SYSTEM 40 track disk 80 track disk £11.95

CHESS ANALYSIS SYSTEM Tape version £9.95

TAPE TO DISK UPGRADE Send old tape £5.00

DATA FILES: Benoni French

Queens Gambit Declined Queens Indian

Kings Indian Grunfeld

Nimzo Indian Sicilian

£2.95* each

*3 or more only £2.50 each. Supplied on tape but CAS allows disk users to transfer data files easily to disk. OR add £2.00 to supply all data files on a single disk. Please state whether 40 track or 80 track
Price inc. VAT & P&P

HORNBY SOFTWARE

Britain's top
Spectrum Pro-Golf Series
now available for the first
time on BBC
Model B 1.2 O.S.



The real thing, exact simulation of Britain's top golf courses.

1. All golf rules apply.
2. Designed for one or two players.
3. Played off any handicap.
4. On each hole, distance, par, green enlargement.
5. Control shot - choice of all clubs, strength, direction.
6. Graphics excellent.
7. Extremely realistic.

TROON £7.75 NEWBIRKDALE £7.75

WENTWORTH EAST & WEST COURSE £11.00

Latest Programme

MOORTOWN PRO-TOURNAMENT

COURSE 1984 £7.75

ALSO SPECIAL OFFER

FULL SERIES £28

All prices include VAT & P&P

Available from:

HORNBY SOFTWARE
21 Pinfold Hill, Leeds LS15 0PW.
Telephone: 0937 65847

SKC
MINIFLOPPY DISK

PERFECTION ASSURED

FLOPPY DISK MEET ANSI, DIN, ECMA, IBM, JIS AND SHUGART SPECIFICATIONS.

EVERY DISK IS CERTIFIED AND GUARANTEED TO BE 100% ERROR FREE.

ALL THESE PRICES INCLUDE VAT

LOW PRICE - HIGH QUALITY

Boxes of 10 Disks

40 TRACK	S/S S/D	£12.00
	S/S D/D	£12.60
	D/S D/D	£14.80

80 TRACK	S/S D/D	£14.70
	D/S D/D	£18.40

Add £1 Post and Packing

ALSO COMPUTER CASSETTES

Boxes of 100

C10	£26.50	ADD £3.50 CARRIAGE
C15	£27.50	
C20	£28.75	

P.V. TUBES

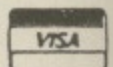

Dept. D
104 ABBEY STREET, ACCRINGTON, LANCs BB5 1EE.

Tel: (0254) 36521. (0254) 32611

Phone in Access/Visa Card number for same day dispatch.

Telex: 635562 Griffin G for PV

THE BEEB BODY BUILDING COURSE

From Page 183

```

620 STA &71
630 LDY &71 \ NUMBER OF ENTRY TO BE
T
640 LDA (&72),Y \ GET ENTRY IN TABL
E GIVEN BY &72,&73
650 STA &FE60 \ OUTPUT IT TO D/A
660 LDA #&20 \ LOOK FOR T2 TIMEOUT
670 BIT &FE6D
680 BEQ HOLD \ NEXT ENTRY IF NOT T1
MED OUT
690 STA &FE6D \ RESET INTERRUPT FLA
G
700 INC &73 \ MOVE TABLE ONTO THE N
EXT ONE
710 DEX \ TABLES TO GO VALUE
720 BNE ST2 \ BACK TO START T2 AGAI
N
730 LDA #&60 \ DISABLE THE TWO TIME
RS
740 STA &FE6E
750 LDA #128 \ SET OUTPUT TO MID PO
INT
760 STA &FE60
770 CLI \ ENABLE SYSTEM INTERRUPTS
780 RTS
790 NOP \ SPACE FOR NUMBER OF HARMO
NICS
800 .TSTART \ START OF WAVEFORM TAB
LES
810 J
820 NEXT
830 ?&79=TSTART MOD 256
840 ?&7A=TSTART DIV 256
850 ENDPROC
860 DEF PROC_NINT
870 LOCAL F,FI,R
880 FOR CX=1 TO 4
890 RESTORE 1030
900 FOR AX=ANOTEX+(CX-1)*24 TO ANOT
EX+(CX-1)*24+22 STEP 2
910 READ F
920 IF CX<>2 THEN F=F*2^(CX-2)
930 FI=F*256*50E-6
940 ?AX=INT(FI)
950 TX=0
960 R=FI-INT(FI)
970 FOR BX=1 TO 8
980 IF R>2^-BX THEN R=R-2^-BX:TX=TX
+2^(8-BX)
990 NEXT
1000 AZ?1=TX
1010 NEXT
1020 NEXT
1030 DATA 261.6256,277.18,293.6648,3
11.13
1040 DATA 329.6276,349.2282,369.99,3
91.9954
1050 DATA 415.31,440.000,456.16,493.
8833
1060 ENDPROC
1070 DEF PROC_PLAY
1080 CLS
1090 PRINT TAB(0,8);"Play the keyboa
rd"
1100 PRINT"SPACE changes the octave"
1110 PRINT TAB(0,12);"RETURN key to
end"
1120 L$="AWSEDFTYHUIJKLP;:()"
1130 ?&76=&10
1140 PZ=0
1150 REPEAT
1160 X$=GET$
1170 AZ=INSTR(L$,X$)
1180 IF AZ=0 THEN 1230
1190 AZ=(AZ-1+PZ)*2
1200 ?&74=ANOTEX?(AZ+1)
1210 ?&75=ANOTEX?AZ
1220 CALL SYNTH
1230 IF X$=" " THEN PZ=PZ+12: PRINT
TAB(0,10);"OCTIVE ";(PZ/12)+1
1240 IF PZ=48 THEN PZ=-12:GOTO 1230
1250 UNTIL X$=CHR#13
1260 ENDPROC
1270 DEF PROC_SOUND(FX,LX)
1280 KZ=2*((FX-1)DIV4)-2
1290 IF KZ>193 THEN ENDPROC
1300 ?&74=ANOTEX?(KZ+1)
1310 ?&75=ANOTEX?KZ
1320 ?&76=LX*6
1330 CALL SYNTH
1340 ENDPROC
1350 DEF PROC_INS
1360 CLS
1370 PRINT"SOUND SYNTHESISER"
1380 PRINT
1390 PRINT
1400 PRINT"P - PLAY the notes from t
he keyboard"
1410 PRINT"L - LOAD the waveform tab
les"
1420 PRINT"T - play a TUNE"
1430 PRINT
1440 PRINT"Make your choice"
1450 ENDPROC
1460 DEF PROC_LOAD
1470 PROC_NAME("LOAD the table from"
)
1480 $CLI$="LOAD T."+F$
1490 PROC_IMPLEMENT
1500 ENDPROC
1510 DEF PROC_NAME(A$)
1520 CLS
1530 PRINT TAB(0,8);"WAVEFORM TABLE
STORAGE"
1540 PRINT"Input file name to ";A$
1550 INPUT F$
1560 ENDPROC
1570 DEF PROC_IMPLEMENT
1580 XZ=CLI$ MOD 256
1590 YZ=CLI$ DIV 256
1600 CALL &FFF7
1610 ENDPROC
1620 DEFPROC_TUNE
1630 RESTORE 1750
1640 QZ=0
1650 READ N$
1660 IF N$="END" THEN ENDPROC
1670 IF LEFT$(N$,1)="O" THEN QZ=VAL(
RIGHT$(N$,1)):GOTO1650
1680 TZ=VAL(RIGHT$(N$,1))
1690 A$=LEFT$(N$,1)
1700 FX=INSTR(octave$,A$)*4+1+48*(QZ
-1)
1710 PRINT N$,A$,TZ
1720 PROC_SOUND(FX,TZ*4)
1730 GOTO1650
1740 REM * WHEELS CHAR-CHAR *
1750 DATA 02,b3,g1,03,d3,02,b1,03,g2
,F2,e1,d1,02,b1,g1
1760 DATA 03,c3,02,a1,03,d3,c1,F2,e2
,d1,c1,02,F1,a1
1770 DATA 02,b3,g1,03,d3,02,b1,03,g2
,F2,e1,d1,02,b1,g1
1780 DATA 03,c1,02,F1,a1,03,c1,e1,d1
,02,e1,F1,g4
1790 DATA END

```

This listing is included in this month's cassette tape offer. See order form on Page 213.



BBC



ELECTRON

LEAVE REALITY BEHIND YOU WITH...

MP ADVENTURE GAMES

A new range of REAL-TIME ADVENTURES we believe the most advanced available for the BBC & Electron: intelligent characters that will move around independently, multiple command statements, advanced text compression methods allow even more detail.

*****NEW*** SADIM CASTLE** It is said that those who enter the haunted estate of Sadim Castle do not return! Long ago tragedy struck here and since then many people have died in mysterious circumstances. Can you uncover the secret and break a terrible curse!!

*****NEW*** VALLEY OF THE KINGS** Far away across the desert lie the lost pyramids of Kaculud, rumoured to contain fabulous treasure and a legendary golden mask. The pyramids may now have been discovered although strange happenings have caused the archaeologists to abandon their camp. Your task is to find the golden mask.

Further titles coming shortly: **CROWN OF MARDAN, THE FALLEN EAGLE.**

Our original and popular text adventures are also available: **FIRIENWOOD, WOODLAND TERROR, BLUE DRAGON, SURVIVOR.** Please send for full details.

Text Adventure Prices: £7.50 (Cass) £10.50 (Disc) including VAT & postage with UK. State which machine when ordering. Dealer enquiries welcome.

MP SOFTWARE LTD.

**165 Spital Road, Bromborough, Merseyside L62 2AE.
Tel: 051-334 3472**

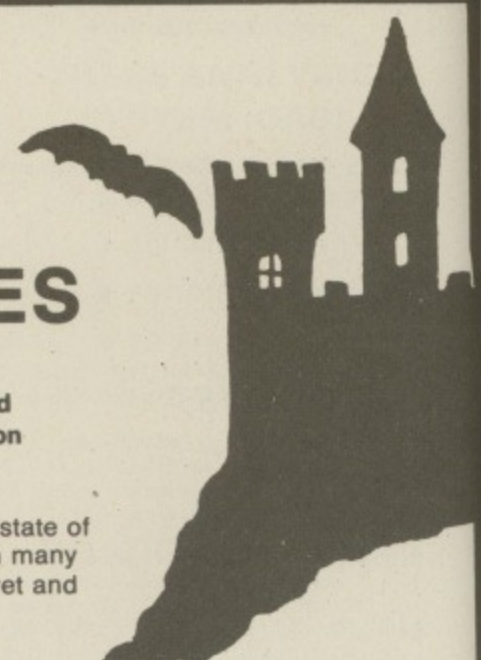
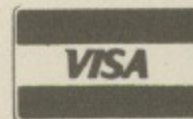

Datapen

BBC Lightpen Programs

Datapen

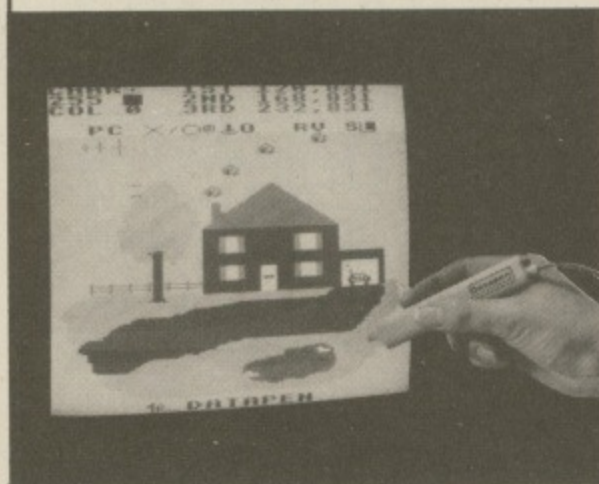

BEEBPEN DRAWING PROGRAM

A comprehensive Mode 2 colour drawing program allowing plot commands, painting, circles, text, character defining, saving and loading to tape or disc, all to be selected and used with the lightpen.
PRICE £11.95

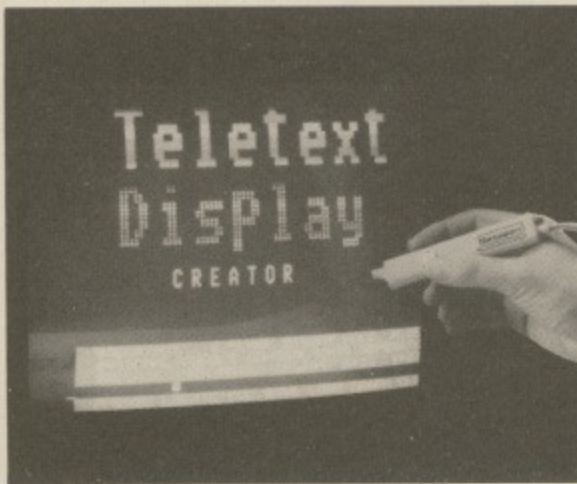

TELETEXT DISPLAY CREATOR/EDITOR

Allows the busy programmer to quickly create Mode 7 colour graphics and test screens for combination into his or her own programs. Movable on screen menu allows use of complete screen for graphics. Full instructions and a discussion on teletext features are provided. **PRICE £9.95**



BRITAIN

The first in a series of educational Geography and Geology programs. Britain comes complete with three sets of tests, and these may be very easily changed by adding DATA statements in the Basic program. Full instructions and grid map supplied.
PRICE £6.95

SUPERIOR PERFORMANCE

- Insensitive to ambient lighting
- Responds to different colours
- Program accessible LED lamp readout
- Switch for program control



SUPERIOR PROGRAMS

- Tape storage of your work
- Good documentation
- User routines provided on tape and on printout

Please deduct £1.50 off each program if more than 1 ordered.

The Datapen Lightpen itself comes complete with handbook, software on tape including two drawing programs and a printed listing showing useful routines.

PRICE £25.00

Two drawing programs, SKETCH and SHAPE-CREATE are included with the lightpen and the programs shown above may be ordered additionally, or separately as required.

All prices above include VAT, postage and packing.

Please send your cheque/P.O. to:-

Dept. MU2 Datapen Microtechnology Ltd., Kingsclere Road, Overton, Hants. RG25 3JB (0256 770488)

Duel listing

From Page 85

```

680 DEFFNboardL(DDZ)
690 LOCALC%
700 D% = 0
710 D% = ((INKEY(-17))*-1)
720 IFD% = 0 D% = ((INKEY(-83))*-2)
730 IFD% = 0 D% = ((INKEY(-67))*-4)
740 IFD% = 0 D% = ((INKEY(-66))*-3)
750 IFD% = 0 =OD%
760 =D%
770 REM*****
780 DEF PROCreadch(H%,V%)
790 TX = ((?(HMEM+(2*H%+V%*80)*8)) A
ND 240)/16:IFTX=0 TX = ((?(HMEM+(2*H%+V
%*80)*8)) AND 15
800 S% = ((?(HMEM+(2*H%+V%*80+80)*8)
) AND 240)/16:IFS% = 0 S% = ((?(HMEM+(2*H
%+V%*80+80)*8)) AND 15
810 ENDPROC
820 REM*****
830 DEFPROCgraphics
840 VDU23,224,51,51,204,204,51,51,2
04,204
850 VDU23,225,128,128,128,128,128,1
28,128,255
860 VDU23,226,255,255,255,255,255,2
55,255,255
870 VDU23,227,0,0,0,0,66,102,60,24
880 VDU23,1,0;0;0;0;
890 S1% = 0:S2% = 0
900 board = FALSE:paddle = FALSE
910 ENDPROC
920 REM*****
930 DEFPROCleftcrash
940 VDU19,1,9,0,0,0:S2% = S2%+1:PROCscore
950 VDU19,1,1,0,0,0,17,3
960 IF S2% = 10 PROCwinner
970 ENDPROC
980 REM*****
990 DEFPROCrightcrash
1000 VDU19,2,10,0,0,0:S1% = S1%+1:PROCscore
1010 VDU19,2,2,0,0,0,17,3
1020 IF S1% = 10 PROCwinner
1030 ENDPROC
1040 REM*****
1050 DEFPROCgrid
1060 COLOUR3:COLOUR128
1070 FORF% = 0 TO 28 STEP 28:FORI% = 0 TO 39:
PRINTTAB(I%,F%);CHR$226:NEXTI%:NEXTF%
1080 FORF% = 1 TO 27:PRINTTAB(0,F%);CHR$226;:FORI% = 1 TO 38:PRINTCHR$225;:NEXT
I%:PRINTCHR$226:NEXTF%
1090 F% = 1:FORI% = 1 TO 38:PRINTTAB(I%,F
%);CHR$224:NEXTI%
1100 F% = 29:FORI% = 0 TO 39:PRINTTAB(I%,F
%);CHR$224:NEXTI%
1110 X% = 15:Y% = 14:AX% = 24:BX% = 14:L% = 2:R%
= 4
1120 ENDPROC
1130 REM*****
1140 DEFPROCscore
1150 TIME = 0:REPEATUNTILTIME = 75
1160 *FX21,5
1170 *FX21,7
1180 *FX21,0
1190 COLOUR3
1200 PRINTTAB(15,13);"Player 1 = ";S
1%;TAB(15,16);"Player 2 = ";S2%
1210 IF board PRINTTAB(6,28);"Press
spacebar to continue" ELSE PRINTTAB(6
,28);"Press fire button to continue"
1220 IF (S1% = 10) OR (S2% = 10) ENDPROC
1230 REPEAT
1240 UNTIL INKEY(-99) OR (ADVAL(0)AN
D3)<>0
1250 ENDPROC
1260 REM*****
1270 DEFPROCwinner
1280 PRINTTAB(10,25);"Player ";:IF(S
1% = 10) PRINT"1";
1290 IF (S2% = 10) PRINT"2";
1300 PRINT" has won...."
1310 S1% = 0:S2% = 0
1320 REPEAT
1330 FORF% = 0 TO 39:PRINTTAB(F%,28);CHR
$226;:NEXTF%
1340 PRINTTAB(8,28);"Press RETURN to
continue"
1350 FOR PAUSE = 1 TO 1000:NEXT
1360 FORF% = 0 TO 39:PRINTTAB(F%,28);CHR
$226;:NEXTF%
1370 UNTIL (INKEY(10)) = 13
1380 ENDPROC
1390 REM*****
1400 DEFPROCsound
1410 ENVELOPE2,3,2,-4,4,5,5,5,127,0,
0,0,60,0
1420 SOUND1,2,1,10
1430 SOUND3,2,200,1
1440 ENDPROC
1450 REM*****
1460 DEFPROCinstruct
1470 VDU23,1;0;0;0;0;
1480 PRINTTAB(17);"DUEL"
1490 PRINT""
1500 PRINTTAB(8);" THE TWO PLAYER GA
ME"
1510 PRINT"" "Your player has been p
laced on the game"
1520 PRINT" board, you must not h
it the walls,"
1530 PRINT" your own or your oppone
nt's ion trail."
1540 PRINT"The object is to force y
our opponent "
1550 PRINT" into an error, such as
hitting an"
1560 PRINT" ion trail or the wall"
...
1570 PRINT
1580 PRINTTAB(12,30);"Hit the space
bar"
1590 PROCbar
1600 CLS
1610 PRINTTAB(17);"DUEL"
1620 PRINTTAB(0,2);"The game can be
played using two methods"" 1. Pa
ddles"" 2. Keyboard : use keys a
s shown"
1630 FORF% = 1 TO 16
1640 READkey,xpos,ypos
1650 PRINTTAB(xpos,ypos);CHR$(key)
1660 NEXT
1670 PRINTTAB(2,18)"Left player";TAB
(28,18);"Right player"
1680 PRINTTAB(15,19);"Please press "
"SPC(13)" "P" for Paddles""SPC(13)"
"K" for Keyboard"
1690 PRINTTAB(5,27);"S" for sound :
"Q" for quiet"
1700 PRINTTAB(12,30);"Hit the space
bar"
1710 sound = 1
1720 REPEAT
1730 REPEAT
1740 IF INKEY(-71)board = TRUE:paddle =
FALSE
1750 IF INKEY(-56)paddle = TRUE:board =
FALSE
1760 IF INKEY(-17)sound = 0
1770 UNTILpaddle OR board
1780 *FX15
1790 UNTILINKEY(-99)
1800 CLS
1810 ENDPROC
1820 END
1830 DEFPROCbar
1840 *FX21,0
1850 REPEATUNTILGET = 32
1860 ENDPROC
1870 DATAB1,7,11,94,7,10,65,7,14,227
,7,15,88,3,12,60,2,12,67,11,12,62,12,
12
1880 DATA91,32,11,94,32,10,42,32,14,
227,32,15,44,28,12,60,27,12,46,36,12,
62,37,12

```

This listing is included in this month's cassette tape offer. See order form on Page 213.

Get more from your BBC Micro with our ROM-Based Software

All prices include VAT. FREE postage.

Full range details on request.

From our COMPUTER CONCEPTS Range:

PRINTMASTER	£33.00	GRAPHICS ROM	£33.00
CARETAKER	£33.00	GREMLIN	£33.00
WORDWISE	£46.00	TERMI	£33.00
DISC DOCTOR	£33.00	COMMUNICATOR	£69.00

Our SYSTEM SOFTWARE selection includes:

SPY 2 £30.00 ADE £60.00 ASM £35.00

BEEBUGSOFT presents:

TOOLKIT £27.00 EXMON £16.00

From PACE SOFTWARE SUPPLIES:

TOOLKIT £34.00 COMMSTAR £34.00

and from LINCOLN MICROSYSTEMS

AID (Dual Screen Monitor) £29.00

Order with confidence. No hidden extras.

A wide selection always available.

TEXTTEL



SYSTEMS

Unit A65, Saltaire Workshops,
Ashley Lane, Shipley, West Yorkshire, England, BD17 7SR.
Tel: Shipley (0274) 588332 24 Hour Answering Service.

MUSICSOFT

MUSIC SPECIALISTS FOR THE 32K BBC MICRO

"A very flexible and inventive program that's highly recommendable." (Dr David Ellis, E&MM, Oct 83). This 'synthesizer' program has features which to our knowledge are unique. ALTER RHYTHM. The rhythm of a recorded melody may be altered by tapping on a single key. REPEAT. No need to play a phrase twice, great saving in space. REAL TIME PLAYING. With alteration of volume, envelope and octave pitch as you play a note. EDITING. Back and forwards whilst hearing the tune. INPUT. May be hesitant or in correct time. TIDY. 'Cleans up' inaccuracies of input on demand! NUMBER OF NOTES. From 3000 for 1 channel to 1000 for 3, etc. Plus all the other synthesizer programs do PLUS, i.e. sophisticated envelope editing (very easy), larger keyboard used (TAB to ↵ cursor). No secrets, user transparent. This is the program for the experimenter who wants to make HUMAN music rather than perform mathematical finger dexterity exercises. THE SYNTH. Cassette & instructions only £8.75 inc. P&P.

★ KEYBOARDS ★ (O.S. 1.0+)

5 programs to turn your BBC into 5 real-time keyboards. 1. 3 simultaneous voices (in Basic for easy understanding) 2. Single voice M/C with Pitch Bend. 3. 3 simultaneous voice M/C with Envelope control built in. 4. Single finger Chord organ ranging over the whole keyboard, 2 variations for each chord. 5. Chord organ 2 with different chord configuration. These are all separate programs designed for you to use as they are or in your own programs.

KEYBOARDS cassette & instructions £5.75 inc P&P

★ MUSICTOOLS ★ (all O.S.)

"Musicsoft also produce an excellent 'Musictools 1' cassette . . . all in all, rather good value" (E&MM, Oct 83)

Five music utility programs on one tape.

Tune Generator with dynamic graphic Keyboard & Stave display, Envelope Command Explorer (Very easy to use), Musical Symbols Graphic routine, Simple single line organ with sophisticated controls. Over 60 procedures for you to use in your programs already in working programs.

MUSICTOOLS 1 cassette & instructions £5.75 inc. P&P.

★ PIEMAN ★ (all O.S.)

"The best version of Simon I've seen, it goes so much further than most" (Quote by a rival software firm!) Recommended for Primary & Middle Schools.

Not as simple as Simon! It develops into a fun set of ear cleaning and musical concentration games.

PIEMAN cassette & instructions £5.75 inc. P&P.

ACORN APPROVED

ALL PROGRAMS TRANSFER EASILY TO DISC.

Cheques and official orders to:

MUSICSOFT, 12 Fallowfield, Ampthill, Beds.

Telephone: 0525 402701

All 4 programs £24.00 - on 40 track disc £25.00

DO YOU BASH THE LIVING DAYLIGHTS OUT OF YOUR KEYBOARD? STOP THIS PRACTICE MUST CEASE

SAVE YOUR BBC KEYBOARD CAMPAIGN

HOW?

By using the Wizard Joy Rom

WHAT DOES IT DO?

It gives you full keyboard simulation direct to your joystick port. All you have to do is address the Rom with *JS and follow the on screen instructions by defining the keys you wish to use.

HOW DOES IT HELP ME?

It enables you to play keyboard only games on your joystick. Converts games that normally require proportional control to work on a switched joystick (these include 3D Bomb Alley and Aviator). If you have twin joysticks you can mix the controls of one game onto both joysticks. Can you imagine playing Snapper with one player going left and right and the other going up and down! "It's havoc."

WIZARD

The Rom retails at

£17.50 inc VAT.

DEVELOPMENT

AVAILABLE FROM ALL GOOD COMPUTER DEALERS OR DIRECT FROM WIZARD DEVELOPMENT.

All dealer and distributor enquiries to Wizard Development,

22 CARVER STREET, SHEFFIELD S1 4FS. (0742) 752732

The No.1 Football Game*

Now available for the BBC model 'B'

BBC Model 'B',
ZX81 16K,
ZX Spectrum 48K
and Commodore 64

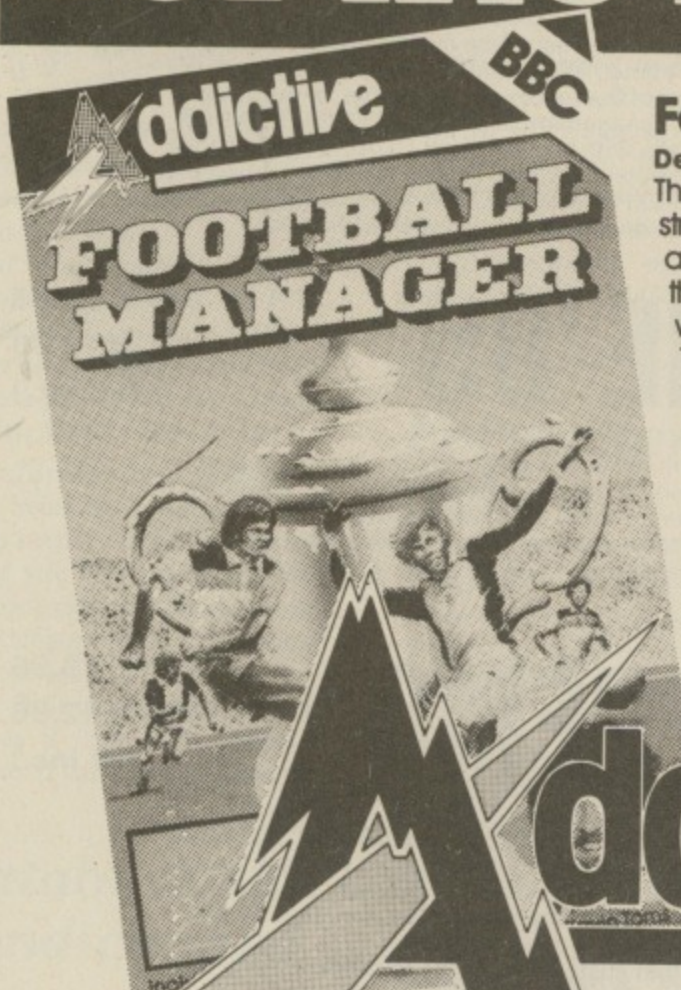

Football Manager

Designed by Kevin Toms

This outstanding game of skill and strategy is now widely available and you can join the many thousands of satisfied customers who have purchased the game. This is no five minute wonder – you will be playing this game for hours over many weeks (we know – our customers tell us!).



Kevin Toms

Some of the features of the game:–

- ★ Matches in 3D graphics
- ★ Transfer market
- ★ Promotion and relegation
- ★ F.A. Cup matches
- ★ Injury problems
- ★ Full league tables
- ★ Four Divisions
- ★ Pick your own team for each match

- ★ As many seasons as you like
- ★ Managerial rating
- ★ 7 skill levels
- ★ Save game facility

Addictive

* Home Computing Weekly BBC Charts
4 Weeks at No. 1.

promoted to division one and possibly win the FA Cup as well. If the team closest to your heart is not available, the game allows you to customise the data file to include your own team and players.

Among the many other options offered are seven skill levels ranging from beginner to genius. If you start as a beginner and do well, your rating is adjusted automatically at the end of the season. The most crucial decision affecting your team's performance, however, involves the selection of players and it is based on the attributes of the two opposing teams. Their energy, morale, defence and attacking strength are valued on a scale of points, and players are chosen according to positional skills and energy they can bring to the team. True to life, players' energy is depleted after a game and restored after a rest.

Having settled all the details, you can then sit back and watch the game – a short, animated sequence showing the 'highlights'. Scores, injuries and new league placings are all displayed at the end.

The combination of graphic action and informed decision-making distinguishes Football Manager from many other strategy games and the scope and careful presentation of the program make it entertaining and absorbing.

(Acorn Programs – August/September 1984)

DIVISION ONE

As Automata have also proved. Addictive Games has shown that it is possible to write excellent programs in Basic – Football Manager started life as a ZX81 program ages ago and is still going strong.

The latest version is the most impressive yet, running as it does on the BBC B, the action is fast and the animated football sequences most impressive. On the BBC the little men have evolved from match-sticks to Subbuteo figures. Another addition is the provision of a fixture list which you can consult.

Apart from that, it only remains to summarise the game for those people who don't know it. As a football manager you choose the teams buying the players, deciding who to play, keeping morale high and basically living out your footballing fantasies as you try to move your team up the divisions.

Matches are decided according to a vast number of factors, only one of which is luck, and you get to see the highlights of each game.

Quite honestly, John, I think you're going to be over the moon about this one unless you're strictly TT on footballing matters in which case you'll probably be sick as a parrot, squire.

(Popular Computing Weekly).

Programmers

We want your software. Send us a sample. If accepted, we will supply generous royalties plus free advice from Kevin himself!

Football Manager from Addictive Games should send soccer fans 'over the moon' but the game scores highly with non-enthusiasts, too.

As manager of your favourite team, it is your job to decide each week who will play in the next match on the fixture list, whether to buy or sell players, and whether to borrow money or repay a loan according to the club's financial fortunes.

Whichever team you choose, you start in division four. By the end of 22 League matches, you hope to be

Available from software stockists nationwide, including WHSMITH & John Menzies

Prices:	BBC Model B	£7.95
	Spectrum 48K	£6.95
	ZX81 16K	£5.95
	Commodore 64	£7.95

(N.B. 3D GRAPHICS ARE NOT INCLUDED IN THE ZX81 VERSION).
Overseas orders add £1.50

To order by mail (p&p free) send cheques or postal orders to:

Addictive Games

7A RICHMOND HILL, BOURNEMOUTH, BH2 6HE

Dealers! For urgent stocks send your headed notepaper direct to our address.

DEPT. CES,
18 HAZELMERE RD,
STEVENAGE, HERTS
SG2 8RX.

QUAL-SOFT

STEV (0438) 721936

NEW GENERATION LEISURE SOFTWARE

QUAL-SOFT comments: In 1982/83 it was only necessary to throw together a few M/C code routines, record them on a cassette, produce a flashy cassette insert, and it sold. But as we approach 1985, BBC users have become much more discriminating in their choice of software. Customers demand something more satisfying than a few hours of high adrenalin action. They demand, not hours, but tens of hours, even a hundred hours plus, of "playability". They demand that the program challenges their intellect and not just their reflexes. They demand QUALITY games. For the 84/85 season; for these customers, QUAL-SOFT is proud to offer these games:

"DIVISION ONE '85" and "SOCCER SUPREMO" are direct descendants of the 1983 game "LEAGUE DIVISION ONE", but they are a significant advance on what was described as "by far the best game for the BBC Micro". They are soccer management SIMULATIONS! Soccer management is about ASSESSMENT; assessment of the opposition strengths, of your players and their skills, of the effectiveness of the teams you assemble, of the value of transfer listed players, of the potential of your own youngsters. Soccer management is about EXPERIMENTATION; experimentation with players, with blends of players, with team formations, with tactical ploys. QUAL-SOFT's unique soccer match simulation, with tackles, passes, shots, saves etc. all simulated within your micro, and the results displayed in graphical form on your screen, allows ASSESSMENT and EXPERIMENTATION to be carried out. The result is a 2ND GENERATION soccer management SIMULATION, not an exercise in mental arithmetic.

BBC 'B'
(all OS)

DIVISION ONE '85'

TAPE £9.95
DISC £12.95
(all inc.)

This is an uncompromising strategy/tactics simulation, it will test to the full your knowledge of the game and your ability to use it to build a winning side. As described above, your ability to experiment and judge the results are paramount. Injuries, suspensions, long term "form" changes, short term "form" fluctuations, will all conspire to confuse and defeat you. You will also meet the problems of financial limitations as you choose between the 33 players available to you. You have a contract for 5 seasons, which will be terminated if your side is relegated. This game is the supreme test of your managerial skills, short of the real thing.

ELECTRON
BBC 'B' (all OS)

SOCCER SUPREMO

TAPE £9.95
DISC £12.95
(all inc.)

Soccer Supremo has been improved over the original game in the direction of a much more realistic "3D", 22 MAN, FULL PITCH match simulation for each of your games. The game is still a significant challenge to your managerial skills, but the balance is more towards enjoyment and entertainment than all out strategy. But with 30 players to choose from, restricted finances, and just a 5 season contract, the 1st Division Championship is not an easy task.

COMBO OFFER. Telephone conversations, and orders, have shown that customers find it very difficult to choose between the two games. Our COMBO tape/disc offers you both games for just £3 extra. £12.95 or £15.95. PREVIOUS OWNERS. Send in your ORIGINAL tape/disc of LEAGUE DIVISION ONE, with manuals, and receive £7 for your tape or £9 for your disc, discount against any order for the above game(s).

BBC 'B'
(all OS)

PORTFOLIO

TAPE £9.95
DISC £12.95
(all inc.)

The most popular indoor games have always been multi-player board games, and yet designers have insisted on producing single player "me and my micro" computer games. In the USA the balance has already shifted away from the "arcade mentality" towards multi-player programs. PORTFOLIO is an investment game for 1-4 players, or teams of players. Each player/team begins with £1,000 and invests his money in a variety of companies against a background of continually changing international, national and commercial news. The news items affect the share values of the companies in a variety of different ways, and the players must shift their money around to maximise their investments; maybe even to become a millionaire.

The game is an ideal family game, or perfect in the classroom with a high pupil/micro ratio. It's suitable for 12 years old and above, though younger do enjoy the game with some help from their friends, and in this game, competitors. For the adult we have made some of our news items somewhat cryptic, occasionally even red herrings, to really make them think about the effect on share values. Because we call it a family game we have tried to see that there is something in it for all members of the family. Teachers can even tailor the news items to suit the capabilities of the pupils.

So why not set your Beeb on the coffee table, connect it to the TV set and play against the rest of the family or your friends on these cold, wet winter nights that are approaching. It might even bring back the art of conversation (as against BASIC statements).

All orders DIRECT SALE.
Orders by post delivered
in 3/4 working days.
ACCESS telephone
authorisations 1/2 days.

	TAPE	DISC
£9.95	<input type="checkbox"/> DIVISION ONE '85'	<input type="checkbox"/> £12.95
£9.95	<input type="checkbox"/> SOCCER SUPREMO	<input type="checkbox"/> £12.95
£12.95	<input type="checkbox"/> COMBO, DW1+SS	<input type="checkbox"/> £15.95
£9.95	<input type="checkbox"/> PORTFOLIO	<input type="checkbox"/> £12.95

Name:
Address:
.....
.....
Card No:

MICROMAIL



Castle of Fear keeps its secrets

I WOULD just like to say thank you for the descriptions of how the programs published in *The Micro User* work.

But what happened to the description of *Castle of Fear*, *The Micro User* August 1984?

It's needed desperately. Hope you can find it for me. — Andy Reader, Potters Bar, Herts.

● Unfortunately, *Castle of Fear*, being an adventure game, has to keep its little secrets. Even telling you that describing how the program works is giving something away, is giving something away!

So far, nobody has actually told us if they've managed to survive. It can't be that hard, can it?

Database for handicapped

WE are in the process of establishing a database of software for the handicapped — Bardsoft.

Briefly, each entry to the database will contain a description of the programs, the handicaps they are suitable for, the type of computer system required, name and address of supplier/developer and price, etc.

This information will be made available through printouts in answer to specific enquiries.

The aim of Bardsoft will be to facilitate the exchange of information on software relevant to any aspect of the lives of handicapped people. One major addition will be the concerted effort to promote the database, and therefore the software, abroad.

This is what we have been doing successfully for non-software products in the field.

As we are currently collecting and processing information, we

would be pleased to hear from any of your readers who may wish to contribute to Bardsoft.

For further information please contact me. — P. Curran, Handicapped Persons Research Unit, Newcastle upon Tyne Polytechnic, No. 1 Coach Lane, Coach Lane Campus, Newcastle upon Tyne NE7 7TW.

Formatter failure

I FOUND the teletext screen dump routine in your September 1984 issue superb!

But I would like to point out that your listing formatter has introduced a space into line 1490. The program will fail to work unless the space is deleted.

Try replacing 'OR A' with 'ORA'. I hope this helps the non machine code programmers who did not notice the mistake. — Andrew Farrow, Walkeley, Sheffield.

● Well spotted! Our late, unlamented formatter let us down there. We hope it didn't cause any serious heartache.

Olympic ordeals...

I WOULD like to compliment you on your excellent game *Micro Olympics*. However, I have but one complaint, couldn't you make some of the events a little more competitive?

For instance, to achieve the necessary running speeds to be competitive with the micro, at the pole vault and long jump, you must need to be bionic!

Surely if I can run 100 metres in 9.42 seconds I could just about gather enough speed to vault above 4.5m or jump more than 6.10m?

In addition to these alterations being made, further

editions of the game could contain events such as the hurdles and shot putt, maybe even a decathlon style points system could be incorporated?

Anyway *Micro Olympics* is still an exceptional game and below I have listed my personal best score for each of the events.

100m	9.42 secs.
200m	20.12 secs.
400m	46.66 secs.
800m	2:01.6 secs.
1500m	3:51:93 secs.
Javelin	100.11m
Discus	72.18m
Hammer	85.09m
Long Jump	6.10m
High Jump	2.40m
Pole Vault	4.50m

Yours with very tired fingers. — Paul Vanags, Mansfield, Notts.

Olympic spirit...?

IS 6.72 seconds in the *Micro Olympics* 100m impossible?

Well, impossible has been made possible — I have found out a way to beat the micro every time.

Apart from having a partner and each individual pressing like mad at their key, I have discovered an ever effective way of beating the micro and it's guaranteed to work every time.

First, the keyboard repeat delay and repeat period must be quickened before loading the program:

*FX 12,1

*FX 11,10

This sets the repeat delay to one-tenth of a second and the repeat period to one-hundredth of a second.

Next, load the *Micro Olympics* running program. When it has loaded, use Z and z (other letters may be used) for your feet and turn the caps lock off.

All you need do now, when

running, is to keep Z pressed down and tap like mad on either one of the Shifts.

As with all methods there is one small problem. If another key, apart from Z and Shift is pressed your man stops running and Z has to be depressed and pressed again to remedy the problem. — Hon Li, Faberstown, Nr. Andover, Hants.

● Well done young man, but our expert can equal your time without cheating.

Larger disc titles

I THINK your magazine is great and there are lots of good things to read.

Could you tell me how to make titles on discs longer so I can put in colour and more words? — Paul Gilliam, Sharow, Ripon.

● Disc titles are limited to 12 characters. This limit cannot be increased without changing the disc filing system's software.

It should also be noted that a control code, such as colour, counts as a single character and can be entered in the disc title as normal using the function keys.

Rugby union plea

I HAVE been trying desperately for about two years now to find a rugby union program.

I have written to many software houses to see if there are any future plans to produce a rugby union program — as I'm certain there are no commercial programs, or listings available — and always been met with a negative answer. Or the ultimate in stupidity — why not write one yourself?

Therefore, I am asking des-

MICROMAIL

A software diagnosis

From Page 191

perately again, do you know of anyone who may have written a rugby union program?

Surely there must be some Twickenham mad micro boffin with a Beeb somewhere.

I would greatly appreciate any help you could give. — Stuart Roscoe, Fleckney, Leicestershire.

Number-to-string alert

I BOUGHT my BBC Model B in early December last year. It has Operating System 1.2. It also has some idiosyncracies in handling number-to-string conversions.

For instance:

```
A=57.6:PRINT LEN(STR$(A)) returns 11 instead of 4.
A=48.82:PRINT LEN(STR$(A)) returns 11 instead of 5.
A=522.44:PRINT STR$(A) returns 522.4400001.
```

Many number-to-string conversions are handled correctly. When I went back to the shop suspecting that I had a rogue machine, it was discovered that all the BBC Micros in the shop performed similarly with the examples given above.

So does my brother-in-law's machine, bought last autumn, but not that of a work colleague who got a BBC Model A last spring.

I have written to Acorn, of course, but do not expect a very quick reply.

It is a real nuisance because it stops data entry verification routines which check the length of an INPUT, and it plays havoc with screen formatting if numeric data is being handled in the string equivalent.

I thought your readers might welcome this warning.

Thank you for a good read. I'm sure to get good value from my annual subscription for *The Micro User*. — C.J. Rourke, Watford, Herts.

Self deleting downloader

AS a newcomer to the world of

WITH reference to the letter of K. Pigge of The Hague and his trouble with the AUTO command and a little white dot that appears on the screen, I would like to suggest a software diagnosis rather than the suggested "definite memory fault".

If while programming, the screen mode is changed from Mode 7 to Mode 1 by typing Ctrl-V followed by a 1, this apparently has an identical effect to Mode 1.

But as page 383 of the User Guide points out it "is exactly equivalent... except that it does not change HIMEM".

This pseudo-variable, as shown in the diagram on page 500 of the User Guide is the address of the top of the Basic

stack.

HIMEM is set to &7C00 in Mode 7, and remains here if the mode is changed as mentioned, near the bottom of the Mode 1 screen.

AUTO is one of the commands that uses the Basic stack, and as soon as it is invoked it can be seen to use this area. If text overwrites this visual storage area, or it scrolls off the screen, the command loses its place, and resets itself back to line 10.

Both procedures and functions also use this area. Trying to access even a non-existent function (type 'PRINT FNx') will show the stack space required.

For the more advanced programmer, the Basic stack space

used by functions is best illustrated with recursive functions. For example, after entering Mode 1 as described, define the recursive function:

```
10 DEFFNsum(X%) :IF X%=1
THEN =1 ELSE = FNsum( X%
-1)+X%
```

Then in immediate mode, type:

```
PRINT FNsum(600)
```

You will be able to see why recursive functions are wasteful on memory.

The moral of this tale is never change mode other than by using the MODE command unless you know the exceptions. — Ian Tresman, Elstree, Herts.

Thanks for Big Letters

A BIG thank you for the Big Letters article and listings in the May issue of *The Micro User*. This was just what I was looking for!

The program runs perfectly on my Electron, and can easily be made interactive by the addition of the lines:

```
INPUT a$:PROCwriteword
(x,y,a$):
```

as appropriate.

This was my first encounter with a machine code program, and unfortunately the article did not explain how to save it so that extra copies could be made.

A friend with a BBC micro advised me to:

```
*SAVE "FCODE" D02 DFF D02
```

This seems to work OK. Is this the best way to do it?

Thanks again to Mike Bibby and your magazine for providing such a useful program. — David Carr, Upper Hutt, New Zealand.

● Nice to know Big Letters has proved so useful. Since it's been published it's turned up in all sorts of programs — look at the title page of *Micro Olympics!*

The way of saving the code

discs, I encountered the dreaded "No room" and "Bad mode" error messages.

The problem, of course, is solved by using a downloading routine. This involves setting up a function key with the required program to do so.

However, usual methods require you to set the function key up, then load the program and finally press the function key. Although this is effective, I decided that it was too much bother.

Below is a self-deleting downloader, which should be placed at the start of the program.

Thanks for a superb mag.

```
1 IF PAGE = &E00 THEN 5
2 *KEY 0 *TAPE IM
DX=PAGE-&E00: FOR LX=PAGE
TO TOP STEP 4
:!(LX-DX)=!LX: NEXT:
PAGE=&E00 IM OLD IM DEL.1,4
M RUN IM
3 *FX 138,0,128
4 END
5 REM Rest of program
```

— David Price, Buxton, Derbyshire.

you describe is fine, providing you've already assembled the code. Being lazy, if we wanted an extra copy, we'd simply run the program again.

Help to stop head banging

RECENTLY I bought the S-Pascal disc with the intention of getting to grips with this language.

There are however some mistakes in the User Manual supplied with my disc, so with much head banging against the wall, pulling out of hair and some very helpful advice from those nice people at Acornsoft I pass on a few tips to anyone who cares to use this piece of software.

To be able to enter your own source code — Pascal program — and save it, the following sequence of events must be followed.

1. Boot loader, Shift and Break, 2. Type *EDIT Lists program "HELLO", 3. Type NEW (not *NEW) Erases loader.

You may now type in your own source program, supplying your own line numbers or type AUTO for the automatic line numbering facility (*NEW does some horrible things to the

● Want to write to Micromail? The address is: Micromail, The Micro User, Europa House, 68 Chester Road, Hazel Grove, Stockport SK7 5NY.

program you have so carefully typed in).

To edit your program, use the normal editing facilities. That is the cursor keys, Delete and Copy as the case may be. CLS and LIST or L. also work.

You can also save your program directly at this stage, in case you lose it when compiling. Do not use Escape, and *EDIT will only list your program again.

Next step is to *COMPILE your source program. If it fails then pressing any key (well Shift does not for a start) will display the program on the screen.

Use the normal on screen editing facilities to correct the program. Save the program and *COMPILE again. Repeat as many times as necessary.

*COMPILING gives a complete assembler listing of the machine code generated (useful stuff this!). It is a two pass assembler.

If you have a printer and use fan fold paper, position the paper at the start of a page. This usually means that the first page is left empty and can be used as "rough".

Turn the printer on; it will recognise this position as being line one. Enable the printer either by Ctrl B or VDU2.

Type *COMPILE. When it has finished listing the assembler (twice) press any key to get a listing of the program. Next type *GO.

The result will be that the assembler will be listed at the start of a page. The program listing will also start on a fresh page, as will be the output from the program.

All very neat indeed. — C.B. Geiser, Nazca Software, Ilford, Essex.

Finding those hidden PROCs

I HAVE a superb way of finding which lines PROCs hide at in a program without searching all the way through it.

This is done by making a list of the line numbers where the DEFPROC occurs and including them at the start of the program.

The list consists of GOTO

statements which point to the PROCs. For example the program may look like this:

```
10 GOTO150
20 GOTO212 Dead
30 GOTO402 Screen
40 REM The rest of your PROCs
"
"
150 REM Start of program
"
212 DEFPROCDead
"
402 DEFPROCScreen
```

When the program is renumbered, the list of GOTO statements is updated. The GOTO at the start of the program jumps round the list of GOTOs, therefore the list is never executed.

I hope this will be of use to

your readers. — T.W. Blunt, Berkshire.

Dummies are the answer

IS it possible to get an underlined, centred, heading using Wordwise and an Epson FX80 printer?

I have tried various configurations of the CE and OC codes, but I always finish up with the leading spaces underlined.

I can overcome this habit of my FX80 in my own program by printing spaces before I send the underline code, but Wordwise does not seem to do this. — Brian Kingham, Skegness, Lincs.

● Unfortunately the only way to centre and underline headings

using Wordwise is to put dummy spaces followed by the required control codes.

Your're quite correct!

I RAISE two points concerning the September 1984 issue of The Micro User.

The circuit on page 140 (frequency meter) will not work as printed. The +5v must go to pin 4 of the LM324 and not pin 5 as indicated.

On page 179, I.A. Padgett writes about a Speedier Micro. Either I'm going mad or my machine is, but with DFS and Basic 2, the loop executes no faster.

What does happen is that the

The dreaded 19th letter

IMAGINE a body of men proclaiming that you are no longer allowed to employ the 19th letter of the alphabet in anything you write. For all your life that letter has been permitted, but now unexpectedly no longer may you include it in any writing.

In order to remain a good citizen, you yield to the demand and the 19th letter of the alphabet you no longer include in your writing.

For, they proclaim, if you are very careful you can avoid including that letter in everything you do, even though it may give you more than one problem.

I believe a gentleman proclaimed that if you employ that letter even one time, you might do it a hundred times, and that could be hard for anyone to read, finding the forbidden letter repeated frequently.

Your writing could end up like a lot of macaroni, I think they remarked.

Advice of a like kind one can additionally hear proclaimed about the employment of a certain four-letter word thought not to be not good to include in any BBC Micro program.

A word that may bring about branching to a numbered line of

the program.

For while any child can comprehend a certain board game wherein more than one venom-giving reptile and more than one ladder are found, an adult reading a program full of branching may become bewildered.

Other methods are advocated, concealing the non-complicated branch in a device called a PROC. For while a non-complicated branch to a line number may be muddling, a PROC branch to a part of the code it can take a minute or two to find, be oddly thought a great improvement.

If the dialect of the number-one-micro computer-language I cannot actually name (on account of the fact that in it one can find the forbidden 19th letter of the alphabet) had not the ability to allow PROC and more PROC, then who can tell, the forbidden four-letter command might after all be permitted.

But unfortunately, the BBC Micro's friendly language does allow the PROC, and moreover, the employment of more than one item of code divided by a colon.

For that the above feature be allowed, the forbidden bran-

ching command be not. Unfortunately, the language of the BBC will not allow the effective employment of more than one antonym of THEN (another four-letter command regrettably featuring the 19th letter).

If one could include the antonym of THEN more than once on a line, then with greater facility might one avoid the dreaded branching word.

But the employment of truly "bird-twig-homed" IF and IF be unhappily not a feature of the BBC friendly program language.

But I have tumbled upon a way out of the above dilemma, which really be very non-complicated.

Never reveal your programming to anyone who might condemn you for any open-minded approach.

Make employment of the dreaded branching word in the privacy of your own floppy-thing.

Or maybe campaign for an edition of the language in which the PROC and multithing are not featured.

Likewise, be bold and say, blast the rules, I need an S to sign my own name! — Colin M. Johnson, Hythe, Kent.

MICROMAIL

From Page 193

timer (TIME) runs more slowly, giving the impression of a faster time.

Checked against a stopwatch, increasing &FE45/46 to 255 makes no difference to the speed. — David Andrews, Harrogate, North Yorks.

● We are grateful for your observations regarding the technical drawing in the Body Building course and you are quite correct.

Your points regarding Speedier Micro are also correct. Your letter is one of many contributions we have had on this subject.

Internal sort routine

I HAVE recently had to develop an internal sort routine to order a number of records specified by DIM record\$(table_size%).

What I did was extract keys into an array DIM key\$(table_size%). The sort, listed below, sorts on ascending key sequence. — Address in Elgin, Moray, but no name supplied.

```

10 DEF PROCsort
20 FOR mZ=1 TO table_size
  mZ
30   FOR nZ=(mZ+1) TO table_size
40     IF key$(nZ) >= key$(mZ) THEN GOTO 120
50     key$(0)=key$(nZ)
60     record$(0)=record$(nZ)
70     FOR oZ=(nZ-1) TO mZ STEP -1
80       key$(oZ+1)=key$(oZ)
90       record$(oZ+1)=record$(oZ)
100    key$(mZ)=key$(0)
110    record$(mZ)=record$(0)
120  NEXT nZ
130 NEXT mZ
140ENDPROC

```

Unstoppable Basic

COULD you tell me how to make my Basic programs unstoppable?

I used *FX220,8 to disable the Esc key while still allowing the action of escape using Ctrl+H.

For Break I have been using *KEY10 and so on but this is not really acceptable as it reRUNs the program from the beginning.

It would be much better if it could continue like those Spectrum gadgets.

Recently the kids in my school have discovered how destructive they can be with Ctrl+Break, Shift+Break, Ctrl+Shift+Break — the latter only works on one of the machines.

Hence in order to help the teachers, is it possible to make the O.S. ignore Break and all such variations of it in a similar

way to which *FX200,1 turns off the Esc key, hence making it unstoppable to those who can't reach the power switch? — John Davies, Newport, Gwent.

PS. I think I know BBC Basic pretty well now, so I want to master 6502 machine code — which book(s) do you recommend? Also does anyone know of an ENVELOPE for the BBC's sound, that sounds anything like a piano?

● The answer to your first question you will find in the August issue of *The Micro User*.

In answer to your second question is that we have found the Shiva book on BBC Machine Code by Bruce Smith very helpful.

Finally, the following should help you with your piano sound:

```

ENVELOPE 1,1,1,-1,0,1,1,-1,
127,-2,-1,-15,126,50
SOUND 1,1,54,20

```

Staggering response!

I REFER to your publication of my letter in the August edition of *The Micro User* asking for help in writing a pottery program, and request that you thank your readers and your staff for their assistance.

Please, no more solutions though. The response was staggering!

Thank you for taking the time and effort to help me. — Neil Robertson, Stonehaven, Scotland.

Regard it as ordinary

COULD you tell me the correct method of typing in the program when using the special formatter which breaks one program line

Setting the Escape trap!

FIRST, let me add my praise for being the first magazine to actually show an honest opinion, and not praising all the time.

I am a beginner in machine code, and I purchased *Assembly Programming Made Easy For The BBC Micro* by Ian Murray. I decided to change one of my early Basic programs to machine code.

How do you trap Escape, such as ON ERROR GOTO or *FX220,x and BREAK, such as *KEY 10 OLD:M RUN:M in machine code.

I would be grateful if you could print the commands, and how to use them in the magazine. — David Trounce, Stafford.

● Trapping the Escape and Break key in machine code involves executing several *FX commands.

To simulate the *FX command in machine code involves setting the A, X and Y registers to their appropriate values and calling the OSBYTE subroutine, which is located at &FFF4. *FX200,1 will disable the Escape. its machine code

equivalent is:

```

10 FORL=0 TO 2 STEP 2
20 PX=&980
30 [OPTL
40 LDA #200
50 LDX #1
60 LDY #0
70 JSR &FFF4
80 RTS
90 INEXT
95 CALL&980

```

Disabling the Break key involves changing the Break intercept code. This is done by using the *FX calls 247 and 249 inclusive.

*FX247,76 will indicate to the operating system that a JMP instruction will occur when Break is pressed. *FX248 and *FX249 correspond to the low and high byte of intercept code address. For example, a routine at &904 can be executed on Break by entering:

```

*FX 247,76 <Return>
*FX 248,4 <Return>
*FX 249,9 <Return>

```

The machine code equivalent is:

```

100 FORL=0 TO 2 STEP 2
105 PX=&980
110 [OPTL
120 LDA #247
130 LDX #76
140 LDY #0
150 JSR &FFF4
160 LDA #248
170 LDX #4
180 JSR &FFF4
190 LDA #248
200 LDX #9
210 JSR &FFF4
220 RTS
230 INEXT
240 CALL&980

```

The only way you can ever totally escape the effects of the Break key, though, is to physically disconnect it.

Ian Birnbaum's "Assembly Language Programming", by MacMillan, now into its second edition, covers a random number generator.

over several lines of listing. — E. Clark, Chesham, Bucks.

● The formatter is used for ease of reading a listing. It should be regarded as an ordinary listing when entering the information.

For example:

```
10 MODE7
:PRINT "HELLO"
:FOR X=1 TO 10
:ETC
```

should be entered as:

```
10 MODE7 :PRINT "HELLO"
:FOR X=1 TO 10 :ETC
```

We hope this helps. In fact, we have ceased to format listings.

Harpsichord envelope

I AM developing a music program and I lack one thing — the ENVELOPE statement for a harpsichord.

Congratulations on an

interesting magazine. I have been reading it from the first issue. — J. Allison, Warrington, Cheshire.

● Can any of our regulars take up the challenge? You haven't let us down yet.

Getting them to collide

I HAVE had a BBC Model B for about nine months and have been using it for games and business type programs.

I've had difficulty writing games. I can't get characters to 'know' when they've collided.

I've tried POINT, but it doesn't always work, and I've tried using the coordinates of characters, but that's long winded.

Is there any other way of getting them to collide?

Also, is it possible to get the BBC to talk without buying a

special chip? — David Stone, Berinsfield, Oxford.

● You will find that the POINT command will work, if the correct X and Y coordinates are given.

If you cannot get this method to work then you will have to use the more long winded X and Y coordinate checking routine.

Both the routines above are used in many of the games in *The Micro User*.

Read through some of them and see how the methods have been implemented.

Through the back door

AFTER reading your column in the August issue of *The Micro User* informing BBC users how to "Make your Basic programs unlistable" I found I was unable to get into my program for

debugging reasons.

Could you please tell me how to put a back door into my program as my two friends and I have spent many unsuccessful hours trying to write one ourselves. — Richard, Richard and Marco, Clacton, Essex.

● I'm afraid your problems are of your own making. To make a Basic program 'unlistable' before it is finished is a bit silly.

Your problem will be solved if you remove the control characters and only add them when you are certain your program is complete.

Even then you should always keep a listable version for your own use.

However if you have used exactly the method described in the letter, it can be reversed by the following:

```
!(PAGE+5)=&2A2A2A2A
!(PAGE+9)=&2A2A2A2A
```

46 MIDDLE STREET, BLACKHALL, HARTLEPOOL, CLEVELAND TS27 4EA
Tel: 0783 872430

Microdis

MAIL ORDER ONLY

	Ex VAT	Inc VAT & Carriage
PRINTERS		
Dot Matrix		
Seikosha GP50A (40 column)	83.60	99.95
Seikosha GP50F (Spectrum)	83.60	99.95
Seikosha GP100A (80 column)	133.50	157.50
Seikosha GP100 (Spectrum)	155.50	182.47
Seikosha GP250X	171.00	199.95
Seikosha GP700A (7 colour)	276.50	322.35
Epson RX80	186.00	196.95
Epson RX80 F/T	217.95	254.90
Epson FX80	315.00	366.95
Shinwa CP80	167.20	196.95
Canon PW1080	264.00	309.35
Canon PW1156	327.80	399.95
Daisywheel		
Daisystep 2000	209.00	246.10
Queen Data	213.40	249.90
Juki 6100	320.00	370.00
MONITORS		
Green		
Sanyo 12N	67.00	82.95
Sanyo 12H (Hi Res)	89.50	108.70
Colour 14" Screen		
Sanyo SCM14N (400 dots)	169.00	189.95
Sanyo SCM14M (600 dots)	269.50	315.00
Sanyo SCM14H (800 dots)	382.00	443.95
Microvitec		
BBC		
1431 (452 x 585 dots)	169.95	199.50
1451 (653 x 585 dots)	271.35	316.50
1441 (895 x 585 dots)	379.50	440.95
Sinclair		
Spectrum 1431	194.50	227.75
QL 1451	249.95	291.65
IBM		
IBM 1451	327.50	380.85
IBM 1441	409.95	475.95
MEDIA		
Nashua Diskettes 5.25" boxed in 10's with Plastic Library Case		
40 Track SS SD	14.95	18.20
40 Track SS DD	16.50	19.90
80 Track SS SD	17.50	21.10
80 Track SS DD	19.50	23.35
HEAD CLEANING KITS		
3M Standard	12.50	15.90
De-Luxe	15.60	19.50

LISTING PAPER		
Boxed 2,000 Sheets		
60 GSM (Listing) 9.5" x 11"	10.50	15.60
85 GSM (Letter Quality) 9.25" x 12"	13.40	19.50
COMPUTERS		
BBC Model B	337.50	389.95
BBC Model B with QFS Disc Interface	421.50	488.75
Electron	159.95	187.95
ANCILLARIES		
Acorn Data Recorder	27.95	33.20
Sanyo DR101	27.95	33.20
Sanyo DR202	35.20	42.50
Teletext Receiver	182.95	214.95
Speech Interface Kit	46.90	55.50
6502 Second Processor	171.50	200.65
Z80A Second Processor	299.95	349.50
CUMANA DISC DRIVES		
BBC CSX (Excluding PSU)		
CSX100 40 Track Single Side (100k)	85.50	101.95
CSX200 80 Track Single Side (200k)	108.95	128.95
CSX400 80 Track Double Side (400k)	128.95	151.95
With PSU		
CS100 40 Track Single Side (100k)	108.95	128.95
CS200 80 Track Single Side (200k)	130.95	154.50
CS400 80 Track Double Side (400k)	148.95	175.50
Dual Drives (with PSU)		
CD200 2 x 40 Track Single Side (200k)	192.25	225.50
With 40/80 Switch		
CD400S 2 x 80 Track Single Side (400k)	242.65	283.25
CD800S 2 x 80 Track Double Side (800k)	279.95	326.50
EPROMS		
2764	5.60	7.40
27128	18.50	22.50

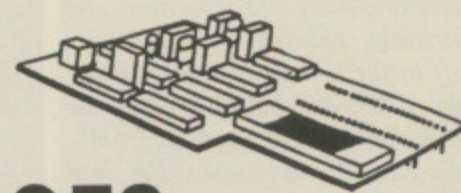

QFS DISC UPGRADE £95

or £109.25 with VAT and Carriage

- Supports SINGLE and DOUBLE Density
- Automatic Density Recognition
- Acorn Compatible
- Supports Single and Double Sided Discs
- Automatically recognises 40 or 80 track discs
- Firmware format and verify
- Simple to fit — supplied with instructions
- Complete with manual
- Available now

FULL RANGE OF GEMINI SOFTWARE AVAILABLE



DISC BASED LABELLING DISASSEMBLER FOR USE WITH VASM™ AND A WORD PROCESSOR (SAE for details)

MICROMAIL

65C02 instructions

IN your September 1984 issue you gave a list of the extra instructions that the 65C02 offers.

For readers who are interested, the Rockwell chip will set the flags correctly when using the BIT immediate command – as shown in Table I – whereas the GTE chip used in the second processor will fail as the main body of the article correctly points out. – **Stuart Morris, Liverpool.**

● Thank you for the information. We would also like to point out that the table of extra commands has a block of opcodes apparently out of place. They are in the correct order,

but should have appeared two lines down – that is, PHY-&5A and so on until JMP (abs,x)-&7C.

Disabling the Break key

HOW can I disable the Break key? By this I do not mean *KEY 10 OLD/MRUN/M but a *FX command like *FX 229,1 used for Esc.

I went to the BBC Micro exhibition in Manchester about a year ago where one person on the Acorn stand said that if I cut a wire in the micro it would disable it.

I'm not going to cut off the Break key for good or I could well have problems!

Also how do I put a mode

command in with procedures? I have a single drive, double sided AMS 3in disc drive, the OS 1.2, and View A1.4.

I think these have taken a lot of memory but all commercial games work. I can't figure it out and my program doesn't work. – **Gordon Price, Monmouth, Gwent.**

● The answer to the first part of your letter is that you cannot disable the Break key using software.

You are not allowed to change mode within a function or procedure.

When an attempt is made to do so, the error message "No room" is produced.

A more appropriate message would be "Bad mode within FN/PROC".

If you use the VDU22,n

command, where n corresponds to the screen mode required, that mode will be entered.

But it is not advisable to use this method, as the value of HIMEM is not taken into account.

Swooping on the eggs

FOLLOWING your articles on ways to cheat in Acornsoft games I have found how to remove the eggs in the game Swoop.

Simply type: CALL &2800.

The title page will reappear and one can continue the game, but pressing Esc returns it to its original form. – **Charles Thackeray, Yeovil, Somerset.**

And finally, with tongue firmly in cheek . . .

Another dragon called A.

Dear Trev,

Sorry it's been so long since I've been in touch but I've been indulging in a bit of speleology (look it up). And I'm still in the dark.

It all started when Clive crept up behind me at a meeting of the Romchester Rogues. One of the whiz kids (known as Spot) was trying to explain to me what an OSBYTE is.

"Bitten off a bit more than you can chew there, old boy", boomed Clive in my ear.

"Here, have a look at this sometime", he muttered furtively, shoving a tape in my hand. I'm off to the lecture on unbreakable protection by B&F. It's being held in the room where all the laughter's coming from".

I eyed the cassette dubiously. I've had unsolicited gifts from Clive before and not always liked what I've found. In fact, I've never had a bacon butty since the last one. And Andrea has insisted on inspecting all my tapes "in case Nigel sees one".

Myself, I think Nigel had written the damn thing. Certainly he has a sort of porcine look to him in dim light.

Still in for a penny and all that (anyway the tape was free). When I got home Andrea was out at her bellringing which meant that she wouldn't be back till long after closing time (which, on these occasions, she calls "closing chimes"). Free from disturbance I ran the program.

PERILOUS POT appeared on the screen in blood red letters and from then on I was hooked.

I'd never played an adventure game before. Of course I've read all Alice's articles and even understood some of the

jokes, but I've never actually dared play one.

I mean, you read the sports pages in the Sunday paper but you don't take on Seb Coe (who I could have done with at one stage of the Perilous Pot).

I've always said I'm waiting for the day when Alice and Mike Cook collaborate, writing an adventure where you have to wander the corridors of Watford Electronics collecting the components for a Body Building pack.

As it was I entered the Perilous Pot without a moment's hesitation. Well, that's not actually true, I spent the best part of an hour wandering round a forest looking down into a valley.

Eventually I sussed it, collected my lantern, food, water, keys and so on and headed for the cavern entrance. I even managed to unlock the gate.

DESCEND HOLE I typed intrepidly. ARE YOU SURE, DUCKY? came the reply. I might have known it was one of Clive's specials.

YES I typed furiously.

DON'T GET YOUR PASSAGES IN A TWIST the micro lisped and I was in the first chamber.

At this point Andrea arrived breathing out clouds of what she insists on calling the "odour of sanctity". "Don't mind me, I'll just watch", she said. I did and she didn't.

OOH, ISN'T IT DARK IN HERE? purred the program.

I did a quick INVENTORY and typed LIGHT LAMP.

"You can't do that", said Andrea, it didn't say you had matches".

"It's a torch", I seethed.

"Go on then, I won't say another word". True to her word she started humming Amazing Grace.

Into the pot I plunged, putting a bat in a cage ("Cruel" pouted A.), picking up the rusty wand (ignoring A.'s remarks) and hunting for the treasure I had to find, the Wizard's Horn Of Plenty.

The calamity came when I met the dragon. Trying to retreat all I got was A BIG STRONG BOY LIKE YOU?

The problem was that I couldn't get past without telling it its name and the only way to get the name was to play a game of riddles with the pink dwarf that had been following me.

You know the sort of thing, "My first is in Acorn but not in Stock" and so on.

Well, I should have known that Clive would have arranged something special. And really, the dragon's name was quite apt. But did Andrea have to be there as I typed it in? She didn't get it and now neither do I.

So, I'm now past one dragon named Andrea but I could do with a cave to hide myself from the real one. All I get from her are game instructions like:

DROP DEAD
and
SLING HOOK

I wonder if Alice does marriage guidance on the side?

Life is strange, cheers,

Bob

P.S. I'm writing to Alice to see if he knows a way of getting the dwarf out of the closet.

ACQUIRE THE RAVEN BOARD POWER

... at Twillstar or your local Acorn dealer

- *20K USABLE MEMORY
- *CUSTOMED MADE

The RAVEN-20 is a 20K RAM EXPANTION for the BBC MICRO, MODEL B, fitted with O.S. 1.2.

This specially designed product plugs in to the C.P.U. socket of your micro (centre socket of the 3 available) with the minimum of effort – the pins are specially custom made, thus avoiding any possible damage to the circuitry!

The RAVEN BOARD provides the user with an extra 20K of usable RAM in screen modes 0 to 3. This together with the aid of software makes the system completely transparent to both the user and the computer.

The RAVEN-20 software ROM gives much more than just the standard commands, it has been programmed to give commands like; "STAR S. SAVE", LOAD for saving and loading the screen, "R. TEST" for testing the board; "STAT" for checking whether Board ON or OFF... and many more unique features – not available in any other product.

The RAVEN-20 comes complete with;

1. RAVEN-20 Board.
2. RAVEN-20 software.
3. Fitting and operating instructions (see picture).

Don't Forget SOFTWARE UPDATE! – return your guarantee/Registration slip and you will automatically be entered onto our files for registration and notification of new software updates!

Purchase with complete confidence on the "TWILLSTAR RELIABILITY".

TCL



TELEPHONE ORDERS
(01) 574 5271

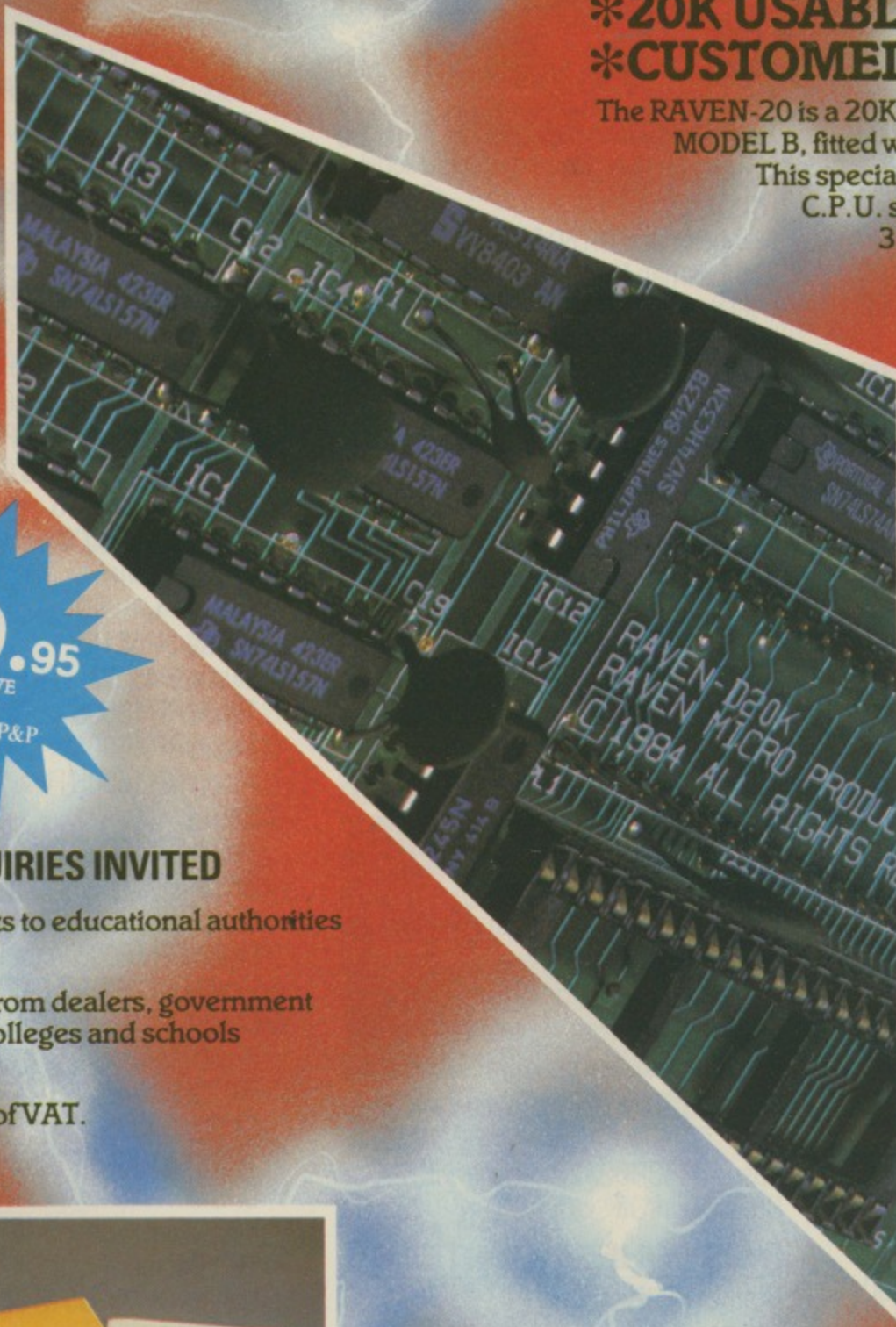

£69.95
INCLUSIVE
VAT
ADD £1.50 P&P

DEALER ENQUIRIES INVITED

- *Service contracts to educational authorities at discount.
- *Official orders from dealers, government departments, colleges and schools welcomed.
- *Price inclusive of VAT.



Specification may change without notice

TCL

HOW TO ORDER

- To purchase the 'RAVEN BOARD', simply write your name and address on a piece of paper, and post to the address below, enclosing your cheque/P.O. made payable to: TWILLSTAR COMPUTERS LTD.
- If you are a credit card holder, simply use the telephone to order.

Twillstar Computers Limited

17 REGINA ROAD, SOUTHALL, MIDDLESEX UB2 5PL. TEL: (01) 574 5271



Twillstar reliability for HOME

COMPUTERS

Commodore 64	£175.00
Oric Atmos 48K	£166.00
Sinclair ZX Spectrum 48K	£115.00
Sanyo MBC 55 128K 2 x 160K	
Drives	£914.25
Acorn Electron	£199.00
BBC Model B	£399.00
BBC Model B + Disc Interface	£469.00
BBC Model B + Econet Interface	£447.00
BBC Model B + Disc & Econet Interface	£517.00
Z80 Second Processor	£399.00
6502 Second Processor	£199.00
Acorn Bitstick	£375.00
Acorn IEE Interface	£325.00
Acorn Electron + One Interface	£59.00
BBC Prestel Adaptor	£132.00
BBC Telex Receiver	£225.00
Amstrad + Green Monitor	£235.00
Amstrad + Colour Monitor	£335.00
Einstein	£499.00

DOT MATRIX PRINTERS

Anadex DP-6500 500CPS	£2321.00
Anadex WP-6000	£2079.00
Brother EP44	£228.00
Brother HR5	£148.00
Canon PW1080A 160 CPS (NLQ)	£289.00
Canon PW1156A 160 CPS (NLQ)	£389.00
Texan Kaga KP810	£279.00
Texan Kaga KP910	£389.00
Ensign 1650 165 CPS	£305.00
Epson RX80T 100 CPS	£224.00
Epson RX80F/T 100 CPS	£253.00

Epson RX100F/T 100 CPS	£439.00
Epson FX80 160 CPS	£370.00
Epson FX100F/T 160 CPS	£494.00
Epson LQ1500 200 CPS (NLQ)	£1029.00
Mannesmann MT80 80 CPS	£199.00
Mannesman MT180 160 CPS (NLQ)	£678.00
Newbury DRE8850 300 LPM	£2409.00
Newbury DRE8925 240 CPS	£1592.00
OKI 82A 120 CPS	£293.00
OKI 84A 200 CPS	£724.00
OKI 92P 160 CPS	£379.00
OKI 2410P 350 CPS	£1765.00
Seikosha GP100A	£165.00
Seikosha BP420 420 CPS (110 CPS NLQ)	£1255.00
Shinwa CP80 Model 11Ft	£199.00
Star Delta 10 160 CPS	£378.00
Star Delta 15 160 CPS	£511.00
Riteman Compact 120 CPS, 80 Col, F/T	£228.00
Star Gemini 10X 120 CPS	£228.00
Star Gemini 15X 120 CPS	£334.00
Star Radix 10 200 CPS (NLQ)	£516.00
Star Radix 15 200 CPS (NLQ)	£631.00
Tec 1550 120 CPS	£534.00
Toshiba TH2100H 192 CPS	£1466.00
Trend 930 200 CPS (NLQ, 80 CPS)	£1552.00
Epson 8143RS232 Interface for FX & RX	£43.00
Epson 8148RS232 Interface with 2K Buffer X On/Off	£65.00

DAISYWHEEL PRINTERS

Brother HR1	£511.00
Brother HR15	£378.00
Brother HR15 Keyboard	£155.00
Brother HR15 Sheet Feeder	£212.00
Brother HR15 Tractor Feed	£71.00

Brother HR25	£631.00
Canon AP400 KSR	£874.00
Daisy Step 2000 20 CPS	£228.00
Diablo 630 API	£1512.00
Diablo Sheet Feeder	£563.00
Fujitsu SP830 RO(S) 80 CPS	£1374.00
Juki 6100 18 CPS	£340.00
Juki 6300 40 CPS	£850.00
NEC 2010 Serial 20 CPS	£741.00
NEC 2030 Parallel 20 CPS	£741.00
NEC 3510 Serial 35 CPS	£1321.00
NEC 3530 Parallel 35 CPS	£1321.00
NEC 7710 Serial 55 CPS	£1723.00
NEC 7730 Parallel 55 CPS	£1723.00
Olympia ESW 103	£948.00
Quendata 20 CPS Unidirectional	£228.00
Qume 11/40 RO	£1362.00
Qume 11/55 RO	£1575.00
Qume 9/45 RO	£1782.00
Ricoh RP 1300S	£1029.00
Ricoh RP 1600S	£1368.00
Ricoh RP 1600S Flow Writer 8K	£1436.00
Ricoh RP 1600S Flow Writer 8K IBM PC	£1493.00
Ricoh RP 1600S Sheet Feeder	£527.00
Ricoh RP 1600S Tractor	£158.00
Silver Feed EXP 550 (P) 16 CPS	£655.00
Smith Corona TIP 12 CPS	£224.00
TEC Star Writer F1040 40 CPS	£1029.00
TEC Star Writer F1055 55 CPS	£1420.00
TEC Sheet Feeder	£527.00
TEC Tractor	£158.00
Uchida DWX-305 (S or P) 18 CPS	£264.00
Juki Single Sheet Feeder	£245.00
Juki Tractor Unit	£108.00
Juki RS232 Interface	£55.00
Juki Spare Daisywheel	£16.00

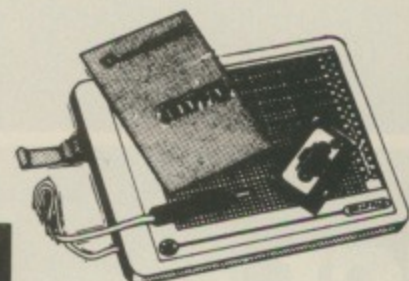
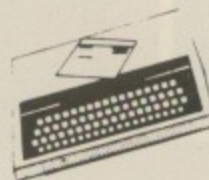
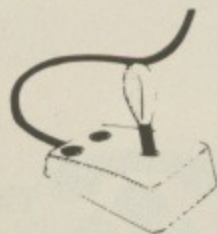

TCL

Twillstar Computers Limited

17 Regina Road, Southall, MIDDLESEX, UB2 5PL. TEL: (01) 574 5271



OME computer users...and



COLOUR PRINTERS

Canon PJ1080A 7 Colour 40 CPS Ink Jet	£399.00
Seikosha GP700A 7 Colour 50 CPS	£399.00

PLOTTERS

Mannesman P1XY Plotter	£569.00
------------------------	---------

MONITORS

Texan Kaga RGB Vision 111 12"	£369.00
Texan Kaga 12"	£118.00
HR Green/Amber Microvitec CUB 1431 Stand RES	£199.00
Microvitec CUB 1451 Medium RES	£299.00
Microvitec CUB 1441 High RES	£399.00
Sanyo SCM 14" VHR Fidelity 12MHZ, RGB, Composite	£425.00
Phillips V7001 HR Green Screen with Sound Input	£195.00
Microvitec FOR QL1451 14" Medium Res	£75.00
Novex 14" Colour Monitor	£270.00
Nordmede TV/Monitor 14"	£215.00
	£249.00

PERIPHERALS

DISK DRIVES

BBC Single 100K Drive	£99.00
BBC Dual 200K	£189.00
BBC Single 200K 40 Track Double Sided	£159.00
BBC Dual 400K 40 Track Double Sided	£299.00
BBC Single 400K 80 Track Double Sided	£175.00
BBC Dual 800K 80 Track Double Sided	£349.00
BBC Single Power Supply	£20.00
BBC Dual Power Supply	£29.00
Disk Drive for Amstrad	£199.00
Commodore 1541 Disk Drive	£179.00

Oric Disk Drives	£263.00
Sinclair 249K Disk Drives	£229.00

ADD ONS FOR THE BBC

Spell Check	£19.00
Tool Kit	£27.00
Star Base	£69.00
Disk Doctor	£32.00
Graphics ROM	£32.00
Microtec Cassette	£49.80
Microtec On Disk	£59.85
Grafpad	£132.00
BBC Cassette Recorder	£35.00
Disk Interface (Free Fitting)	£120.00
Games Paddles	£9.95
Econet Interface	£69.00
Speech Interface	£54.00
View Word Processor	£59.00
Word Wise Word Processor	£37.00
Light Pen for BBC	£45.00
Edward User Pack	£44.79
Edward Teacher Pack	£34.44
Edward Commercial Pack	£59.74

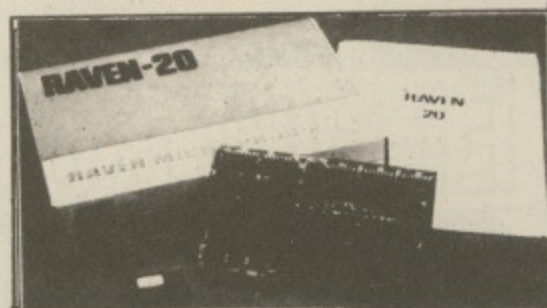

EXPANSION BOARDS

RAVEN-20 BOARD

The RAVEN-20 is a 20K RAM EXPANTION for the BBC Micro, Model B, fitted with O.S. 1.2.

This specially designed product plugs in to the CPU socket of your micro (centre socket of the 3 available) with the minimum of effort. The pins are specially custom made, thus avoiding any possible damage to the circuitry.

The RAVEN board provide the user with an extra 20K of usable RAM in screen modes 0 to 3. This together with the aid of software makes the system completely transparent to both the user and the computer.

The RAVEN-20 software ROM gives

much more than just the standard commands, it has been programmed to give more and better commands! Priced at £69.95 inclusive of VAT. Please add £1.50 for post and packing.

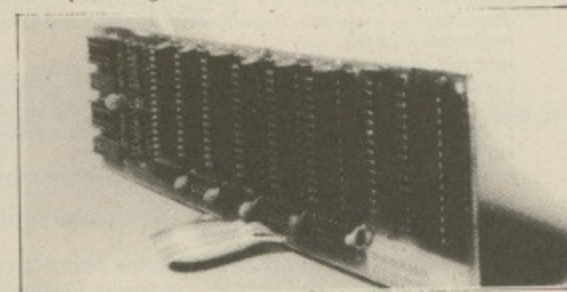

RAM-ROM BOARD

The RAM-ROM extension board gives an extra 6 sockets for extra ROM's and 2 slots of RAM. This RAM is not an extension of BASIC. It is intended that the RAM be used to develop your own ROM based software. There are in fact seven sockets on the board, the 7th replaces the socket on the main board that would otherwise be taken by the ROM board. (The RAM-ROM board can accommodate both 2764 type EPROMS as well as 27128 EPROMS and ROM.)

The RAMAMP board will not cause overheating. it comes with fully fitting instructions, tested and heat tested before depatch.

Prices: Without RAM fitted £33.50. 1 x 6K RAM fitted £47.00. 2 x 16 RAM fitted £59.00

All prices inclusive of VAT. Please add £1.50 for P&P.

HOW TO ORDER

You may purchase any of the items listed by cheque made payable to: Twillstar Computers Ltd. Barclaycard or Access. All you have to do is fill in your requirements on a separate sheet of paper, post to us and we will despatch with 24 hours, subject to availability. All prices inclusive of 15% VAT. ADD £2.50 P&P for orders below £150. Over add £8 P&P. Credit card holders may order by telephone. Give card number, name, address and items required. Please note VAT is not charged on export orders. Export customers please ring for details of P&P.

...ask for our Full range!

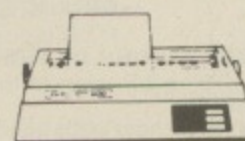

Open
6 days a week
9am to 7pm
Monday to Saturday

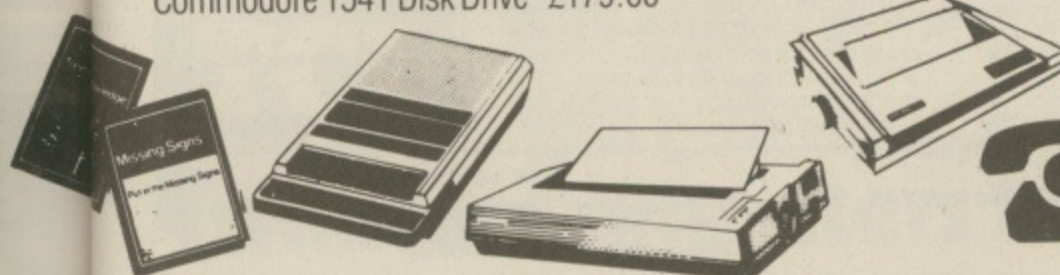

TELEPHONE ORDERS
(01) 574 5271

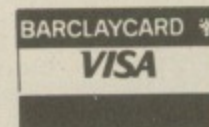

Educational Software **LCL**

MICRO ENGLISH



A COMPLETE ENGLISH LANGUAGE COURSE OF 24 EASY TO USE PROGRAMS FOR 'O'LEVEL SELF-TUITION OR REVISION



**BBC Micro
ZX Spectrum
unexpanded VIC
Electron
ZX81
Apple
PET
Commodore 64
Dragon (book only)
All software for the
above computers.**



MICRO ENGLISH (BBC, Electron) complete English Language O-Level self-tuition or revision course of 24 programs, 2 disks/tapes. Includes "Speak-and-Spell" type program (no extras required) £24.50.

MICRO MATHS 24 program revision or self-tuition course to O-Level. £24.50 (except ZX81 £12.00).

BRAINTEASERS (BBC, Electron, CBM 64, Spectrum, Dragon, Vic) £5.95. "The book is a collection of 29 program listings, each one an interesting and amusing challenge... You'll like this".

ANIMATED ARITHMETIC Teaches using moving colour pictures (not words) Ages 3-8 £6.50 (disc £7.50).

"... the programming standard is high". TIMES EDUCATIONAL SUP.

Immediate dispatch of Micro English, Micro Maths, and Master Maths. Phone or send orders or requests for free catalogue (200 programs) to:

LCL
26 Avondale Ave.
Staines, Middx.
Tel: 0784 58771
24 hrs. Orders

World leaders in Educational software.

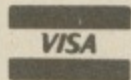

GENEROUS TRADE DISCOUNTS.

SUPERB HARD COVERS for your BBC Micro & Electron

- * Engineered in top quality high impact ABS - very tough
- * Super textured finish in cream to tone with your BBC Micro
- * Looks good in the home
- * Gives excellent protection
- * Ideal for schools and colleges

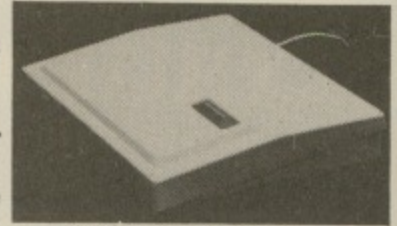

BBC Cover: £10.95
(+£1.55 P&P)
Electron Cover: £8.95
(+£1.00 P&P)

TOP QUALITY MONITOR STAND

A high quality steel stand designed to combine a pleasing appearance with high rigidity. It bridges the BBC Micro and can be used with our hard cover. It has solid rubber feet and has a durable stove enamelled textured finish to match the BBC Micro. Platform dims. 455mm x 260mm. Overall height 105mm. Price: £17.95 (+ £2.00 Post & Packing).

Please send me

BBC covers Electron covers Stands

I enclose a cheque/P.O. for £

Name

Address

Code

MU5 Send to: **Tekform Products**
Grange Close
Sandbach
Ches. CW11 9ET
Tel: (09367) 3098

Tekform

CARE ELECTRONICS

UNIT 14, PEERGLow INDUSTRIAL ESTATE, OLD'S APPROACH, TOLPITS LANE, RICKMANSWORTH, HERTS.
TELEPHONE: 0923 777155

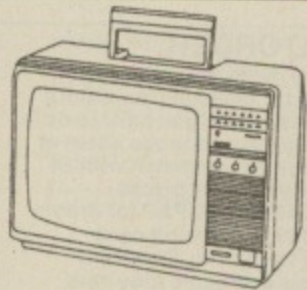

**DON'T BUY A COLOUR MONITOR!!
HAVE YOUR 14" & 16" PHILIPS or PYE
COLOUR TV CONVERTED TO A TV/MONITOR
"ONLY" £49.91a inc VAT.**

- * Image clarity comparable to leading monitors.
- * Includes RGB lead for connecting with BBC.
- * Conversions carried out at our workshops within 2/3 days.
- * Please telephone for other makes.

ROM MODULE SYSTEM

HERE IT IS JUST RELEASED
THE CARE ELECTRONICS LOW PROFILE
ROM MODULE SYSTEM

- Superb styling.
- Low Profile.
- Avoids damage to BBC from changing ROMs constantly.
- Easy to use and install.
- Prices lower than any other ROM System.

Complete Kit £17.25c inc. VAT
Spare Cartridge £4.37c inc. VAT
5 Cartridges £20.70c inc. VAT
10 Cartridges £39.10c inc. VAT

For larger quantities consult our factory at the above telephone number.
● Please note our cartridges are totally compatible with the Viglen ROM System.

RGB CONVERSION KIT
(Please telephone for details)
£38.64c inc. VAT.

**PHILIPS 14" COLOUR
TV/MONITOR**
£234.60a inc. VAT

**PHILIPS 14"
COLOUR TV**
£184.00a inc. VAT.

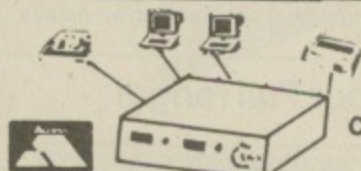

**CARE ELECTRONICS PRESENTS:
CPX2 "X" SWITCHER**

CHANGING LEADS BECOMES A THING OF THE PAST!!!

- 26 pin (As BBC) 2 Micros driving 2 Printers at the same time.
- Can be used as a "T" Switcher.
- All outputs BUFFERED enabling longer leads between units. In excess of 20 metres.
- No strain on your BBC power supply, as the "CPX2" comes complete with its own internal power supply.
- Easy to install and operate.
- Colour Finished to match BBC.
- Supplied with moulded mains plug.
- 12 Months Guarantee.

RS232 SWITCHERS: "ONLY" £85.10b inc. VAT.

"T" £55.20c inc VAT
"X" £65.09c inc VAT

PRINTER SELECTOR
● 26 Pin as BBC.
● 1 Micro to 3 Printers.

£65.09c inc. VAT

POWER SUPPLY UNIT

- Colour finished to match BBC.
- 6 pin BBC Outlet or Dual Power lead for disk drive. (Please specify when ordering).

£32.20b

MAINS FILTER 5 amp

- Noise and Transient Filter.
- 4 Socket outlets.
- Moulded mains plug.

£45.08b inc. VAT

HOW TO ORDER

By post. Enclose Cheque/P.O. made payable to CARE Electronics. Or use ACCESS. Allow 7 days for delivery. Please add carriage. a: £8.00, b: £5.00, c: £2.00.

... Twillstar reliability for BUSINESS computer users!

Telephone
Orders
574 5271

*all prices
inclusive of vat!*

and there is more...

BUSINESS SYSTEMS

SANYO 550

16 Bit Micro 128K RAM expandable to 256K. Single or Double Disk drive built in full colour graphics (640 x 200 pixels in 8 colours) IBM compatible. Free software. Sanyo MBC 550 128K RAM single drive and free software including Wordstar and Calcstar

£862

SANYO 550-2

As 550 but with Dual Drive 2 x 160K

£976

SANYO 550-360

As 550 but with 2 x 360K Drives

£1149

SANYO 550-73

As 550 but with 2 x 730K Drives

£1206

SANYO 555

Sanyo MBC555 128K double drive and free software including Wordstar, Calcstar, Inforstar, Datastar etc.

£1149

SANYO 555-360

As 555 but with 2 x 360K Drives

£1436

SANYO 555-730

As 555 but with 2 x 730K Drives

£1494

WORD PROCESSING

BBC 1:

BBC Micro Model B, View (or Word-wise) Wordprocessor, Quendata 20 CPS Daisywheel Printer, High Res Green Monitor, Cassette Recorder plus 10 cassettes and all the necessary cables.

£747.50

BBC 2:

BBC Micro Model B + Disk Interface, View (or Wordwise) Wordprocessor, 100K Disk Drive, High Res Green Monitor, Quendata 20 CPS Daisywheel Printer, 1 Box of Disks and all the necessary cables.

£803.35

BBC 3:

Same as System BBC 2 but with 400K Drive

£1006.25

BBC 4:

BBC Model B + Disk Interface, View (or Wordwise) Wordprocessor, 800K Dual Disk Drive (Mitsubishi), High Res Green Monitor, JUKI 6100 Daisywheel Printer, 1 Box (10) of 80 Track Disks and all necessary cables

£1316.75

SAN 1:

Sanyo MBC 550 Series 16 Bit Microcomputer, 128K RAM, Dual 160K Drives (2 x 160K), High Res Graphics (600 x 200 pixels in 8 colours), JUKI 6100 Daisywheel Printer, High Res Green Monitor, 1 Box of 10 Disks, Wordstar Wordprocessor, Calcstar spreadsheet and all the necessary cables

£1351.25

SAN 2:

Same as SAN 1 but with Dual 360K Drives (2 x 360K)

£1546.75

SAN 3:

Same as SAN 1 but with Dual 720K Drives

£1604.25

SAN 4:

Sanyo MBC 555 Series 16 Bit Microcomputer, 128K RAM, Dual 150K Drives (2 x 160K), High Res Graphics (600 x 200 pixels in 8 colours) JUKI 6100 Daisywheel Printer, High Res Green Monitor, 1 Box of 10 Disks, Wordstar Wordprocessor, Calcstar spreadsheet, Mailmerge, Spellstar (dictionary), Datastar (database), Reportstar plus all the necessary cables

£1489.25

SAN 5:

Same as SAN 4 but with Dual 360K Drives

£1696.25

SAN 6:

Same as SAN 4 but with Dual 730K Drives

£1753.75

BUSINESS SOFTWARE

	£	£
	Tape	Disk
Cash Book		
Accounts	59.80	63.25
Final Accounts	59.80	63.25
Invoices & Statements	19.84	23.28
Commercial Accounts	19.84	23.28
Mailing List	19.84	23.28
Data Base	19.84	23.28
Stock Control	19.84	23.28
Home Accounts	19.84	23.28
Beebcalc Spreadsheet		
Analysis	19.84	23.82
Payroll	44.85	48.30

ADD ON'S FOR BBC

Complete programme development package on 16K ROM, an absolute necessity for all assembly language programmers

£56.35

MODEMS

WS2000

A world standard direct connect modem switchable between 75,300/300, 600, 1200/75, 75/1200 baud, awaiting BT approval. It is compatible with Bell 103/113/108, 202 and CCITT V21 & 23 standards and allows you to communicate with

virtually any computer system in the world. This is one of the new generation modems, that will probably cover any communications standards you would ever need. This is the modem that will cover Prestel, Micronet, Telecom Gold, Distel, Microweb, One-to-One, Bulletin Boards both in the UK and abroad, ect. etc. as well as user-to-user communication. It also has a rather useful facility of 'Reverse-Prestel' mode i.e. 75/1200 so that you can communicate with other users who only have a standard 1200/75 type modem. What possibly gives this modem its biggest advantage is its option of computer controlled switching between all modes of operation. In addition, separate auto-answer and auto-dial cards are available, giving this modem possibly the greatest potential of all. Mains powered £129(c) Please phone/write for details of optional extras

TELEMOD-2

A BT approved modem complying with CCITT V23 1200/75 Duplex & 1200/1200 Half-Duplex standard, that allows communication with Viewdata services e.g. Prestel, Micronet etc., as well as using 1200 Baud for communicating with other computer users. Mains powered. TELEMOD 2 £65(b) BBC Lead £3.50

HOW TO ORDER

You may purchase any of the items listed by cheque made payable to: Twillstar Computers Ltd. Barclaycard or Access. All you have to do is fill in your requirements on a separate sheet of paper, post to us and we will despatch within 24 hours, subject to availability. All prices inclusive of 15% VAT. ADD £2.50 P&P for orders below £150. Over add £8 P&P. Credit card holders may order by telephone. Give card number, name, address and items required. Please note VAT is not charged on export orders. Export customers please ring for details of P&P.

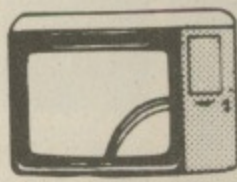
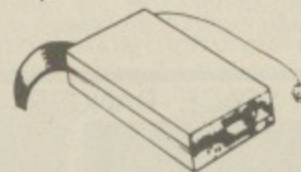

ask for our Full range!
TELEPHONE ORDERS
(01) 574 5271

Open
6 days a week
9am to 7pm
Monday to Saturday

Twillstar Computers Limited

17 Regina Road, Southall, MIDDLESEX, UB2 5PL. TEL: (01) 574 5271



MODULAR MICROCOMPUTER CONSOLES FOR SCHOOLS, HOMES AND OFFICES

Just 2 examples of our extensive range of consoles. This system is easily adapted to suit your personal requirement and can be readily expanded upon. The consoles support your TV/monitor safely above your micro and provide safe storage for disk drive/s, cassette recorder, books etc. The sturdy, well designed, mild steel construction also enables your micro to be stored safely underneath when not in use.

All consoles are formed with double bends to provide a completely safe edge to the front and rear whilst the bottom edge has rubber trim for safe use on desks etc. Attractive textured finish in either black or BBC colour match. Whilst these consoles are designed for the BBC micro they lend themselves perfectly to a variety of other models.

Write or phone for full colour brochure including dimensions and price list.



From £19.75 + VAT

TRADE, EDUCATIONAL ENQUIRIES WELCOME. DISCOUNTS AVAILABLE

J & W BUNCE

Thorpe Industrial Estate, Unit 3, Crabtree Road,
Thorpe, Egham, Surrey TW20 8RN.
Egham (0784) 33555

SPELLWISE

The original spelling checker for WORDWISE. Disk version checks the WORDWISE example document in 12 minutes. Disk £18 Tape £18

SPELLBOOK

EPROM based spelling checker for use with any spooled text - very fast. 16K EPROM £40 8K EPROM (with limited internal dictionary) £25

LANGUAGEWISE

Convert your WORDWISE word processor and Epson FX80 printer into a foreign language processor with a choice of 29 European languages. Disk only £22

TOOLKIT

The easiest toolkit to use - comprehensive set of commands for BASIC (and assembler) programmers. EPROM £22

SLIDEMASTER

Specialised database for the photographer. Tailored for perfect cataloguing of a photographic collection. Disk only £22

MAM

Write your own adventure and test it on the Beeb. Requires Acornsoft LISP to operate. ELIZA is also included on the disk - the classic response program with a difference - you write the rules to suit your requirements. Disk only £12

COMING SOON

SPELLWISE F

Super fast version of SPELLWISE. Six minutes for the WORDWISE example document. Disk only £22

CONTENTS

Produces a page numbered contents list. For use with any word processor which spools the text file. Disk only £22

INDEX

A utility to provide a comprehensive index of any spooled document. Page and line number are referenced. Disk only £22

RUSSIAN LANGUAGE

For View Word processor. Disk only. Price on application.

Further details obtainable from FLOPPYCAT the DATAWARE catalogue - a reusable 40 track single density 5 1/4 inch disk with a 5 year manufacturers guarantee - £3 UK postage paid.

All prices except Floppycat include postage anywhere in the world.

CHROME CASSETTES - special limited offer
C10: 10 for £6; C60: 10 for £15

Limited number available.



DATAWARE

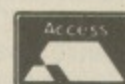

FREEPOST SWINDON SN3 4BR

FOR THE

AMSTRAD ELECTRON BBC

SUPER GAMES

ONLY
£4.95
Including VAT
& Postage

SUP VALUE

Versions:
ELECTRON
AMSTRAD-BBC
FAST - FUNNY
& ADDICTIVE

ER*BERT

ITS ER*BERTS CUBIC DOMAIN - AVOID HIS UNWELCOME GUESTS! GRAB THE BANANA - DOUBLE YOUR SCORES - BUT WATCH OUT - BORIS THE APE WILL SOON WANT IT BACK! DROP IT AND RUN - UNLESS YOU'RE VERY BRAVE! AVOID CASCADING BALLS - THE MOVING HOLE - AND COILY THE ANACONDA, HE'S GOT A CUDDLE YOU'LL NEVER FORGET! ESCAPE WHEN IT'S REALLY TOUGH BY TRANSPORTER DISC OR ROTA HAT - IF YOU'VE EARNED ONE. MULTIPLE SCREENS - ADDITIONAL CHANGE CUBE COLOUR TASKS. IT'S FUN AT LEVEL ONE - BUT WATCH OUT AT LEVEL TEN! PACKED WITH FUN AND EXCITEMENT - TRY IT YOURSELF. (ALL MACHINE CODE).

HI: 000000
LUL 88
HATS 0



3D SPACE RANGER - BBC only



STAR TRENCH
EXCELLENT 3D GRAPHICS
MULTIPLE SCENE SPACE TREK
BATTLE TO THE DEATH
START TRENCH. DESTROY
THE DEATH STAR. FIGHT
YOUR WAY BACK. MACHINE
CODE GAMES (REQUIRES O.S.
1.0/1.2).

Star Surface

PINBALL

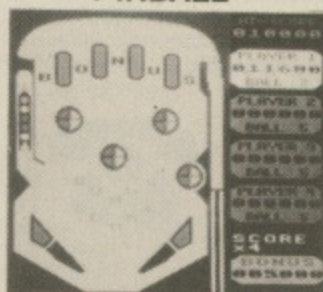

THE CLASSIC ARCADE GAME UP
TO FOUR PLAYERS - HI SCORES,
BONUS FEATURES.
ELECTRON/BBC - MACHINE
CODE

REVERSI

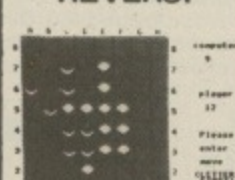

A TRADITIONAL GAME OF
STRATEGY AND
SKILL - 2 LEVELS.
ELECTRON/BBC

DISTRIBUTORS -
DEALERS - CALL
06373 6886
FOR TRADE ENQUIRIES

ILLUSTRATED LEAFLETS AVAILABLE - SEND S.A.E.

GAMES AVAILABLE
AT MANY OUTLETS
OR DIRECT FROM:

ACCESS CARD WELCOME
24 HR HOT LINE:
06373 6886



MICROBYTE SOFTWARE (MU11)
18 HILGROVE ROAD, NEWQUAY, CORNWALL, TR7 2QZ.

MICROBYTE SOFTWARE

CONTRACT BRIDGE

N.B. NOT A FEEBLE ATTEMPT TO PLAY RANDOM HANDS!
BRIDGE-MENTOR is an ideal bridge partner for the BBC Micro.

- Perfect your cardplay ● Improve your bidding
- Archive interesting hands ● Create/Analyse random deals

With high resolution colour graphics and sound of the BBC Micro, **BRIDGE-MENTOR** guides you through pre-analysed hands. A host of features (including the spectacular **AUTOPLAY** option) and grand slam quiz.

- Ideal for individual **PRACTICE, ANALYSIS** and **ARCHIVING**
 - Superb teaching aid for **CLUBS** and **PROFESSIONALS**
- FOR BBC "B" and **ELECTRON** £9.50 inc. post, packing, etc

Cheques to: **MINIC BUSINESS SERVICES**
12 Woburn Close, Bushey, Herts. WD2 3XA.

**HAVING TROUBLE OBTAINING
 QUALITY COMPUTER LENGTH CASSETTES?**

JP MAGNETICS can Solve YOUR PROBLEM

We are specialists in the supply of bulk custom wound audio/computer cassettes to Trade and Education users

DUPLICATION FACILITIES FOR MOST POPULAR HOME COMPUTERS. 16 TRACK RECORDING STUDIO

Contact us for price list/quotations now
Competitive Rates

JP MAGNETICS LTD

Unit 14, 7 Mary Street, Bradford BD4 8SW.
 Telephone: (0274) 731651

BBC POOLS PREDICTOR

WITH 11,000 MATCH DATABASE

Now in its 3rd successful season, Mayday Software's Pools Predictor has been made even more powerful with a new and unique 11,000 match database. Seven separate forecasting techniques have been combined to give you the best forecasts yet. And, just as easy to use, is our new Racing Analyser. This uses the racecard from your daily paper to analyse any horse race — and it's yours for no extra charge!

***** ALSO AVAILABLE FOR THE SPECTRUM *****

MAYDAY SOFTWARE 181 Portland Crescent
 Stanmore, Middx. HA7 1LR.

FREE RACING ANALYSER

BOTH PROGRAMS
 FOR ONLY

£8.99

**FREE
 with "Your Team"
 a Bobby Charlton
 Leather Match Ball
 worth £6.99**

A must for all soccer enthusiasts

Yes, absolutely free for a limited period, with every copy of the program "Your Team" a real leather Match Ball autographed by Bobby Charlton (R.R.P. £6.99). "Your Team" is a database program to record and analyse your favourite teams match results, scores, attendances, statistics etc. All recorded in your clubs colours. Football league, Scottish league or your own team school or club can be kept season after season.

Available for Spectrum, BBC, Electron, CBM 64 — £9.95 plus £1.00 P&P. Order today enclosing cheques/P.O. Access/Visa To:

Bec Sports, Dept MU, Bec House, Highlands Ave, Northampton.
 Tel: 0604 499 246

Offers...like this

Philips V7001 12" Tube High Resolution Computer Monitor...

*Free Cable!
 *Free Paper!

For ONLY £75

INCLUSIVE OF VAT
 (Please add £8 for post and packing)



Size:
 345mm width x 300mm depth x 302mm height!

This special V7001 Phillips monochrome computer monitor comes direct to you from Twillstar Computers Ltd at the exceptional price of £75 inclusive of VAT. Twillstar Computers Ltd have negotiated with Phillips to bring you this 12" Tube high resolution monitor which has been specially designed to display alphanumerical and graphic information, generated by home and personal computers. It offers compatibility with various types of computers, it accepts composite video signals (CVBS) as well as RGB, synchronisation and sound signals! The monitor provides a clearly legible display with a maximum of 80 characters per line and 25 lines per display. The display format is full screen 250 x 200mm. To reduce eye fatigue the picture tube has undergone a special anti-glare treatment. The monitor also features a two position, adjustable stand.

Just look at the features!

1. 12" high resolution picture tube.
2. Two position adjustable stand.
3. Anti-glare treated screen.
4. P31 green phosphor.
5. CVBS input connections.
6. RGB and synchronisation and sound input connection.
7. Sound input 0.3 watts.
8. 18MHz Bandwidth.
9. 2000 character display control.
10. Compatible with home and personal computers.
11. Precision deflection unit for low geometric distortion.

And of course, exterior controls allow you to switch on/off volume, brightness, contrast, vertical size, vertical hold and horizontal size. This unique specially designed monitor measures 345mm width x 300mm depth x 302mm high. **Order now while stocks last!**

HOW TO ORDER

All you have to do is fill in your requirements on a piece of paper with your name and address enclosing your cheque/P.O. made payable to TWILLSTAR COMPUTERS LTD. If you are a Barclaycard or Access card holder, please use coupon and post to address below.

Please allow 14 to 28 days for delivery.

17 REGINA ROAD, SOUTHALL, MIDDLESEX UB2 5PL TEL: (01) 574 5271

...ask for our Full range!

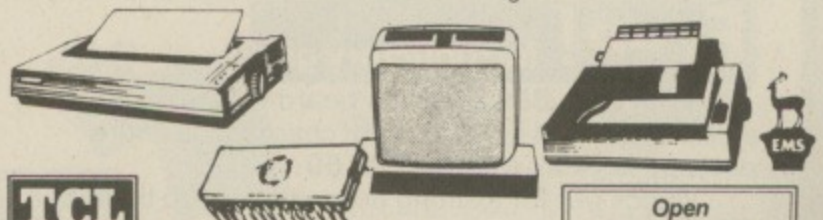

TCL

Twillstar Computers Limited

17 REGINA ROAD, SOUTHALL, MIDDLESEX UB2 5PL TEL: (01) 574 5271

Open
 6 days a week
 9am to 7pm
 Monday to Saturday



TELEPHONE ORDERS
 (01) 574 5271



INTRODUCTION TO THE STARS**FOR ALL AGES

NEW FROM "SMALL SCHOOL SOFTWARE"

SUPERB 'STUDY PACK' OF THE CONSTELLATIONS AND STARS OF THE NORTHERN SKY.



- * Sophisticated menu driven suite of six programmes
- * Special programmes teach recognition of constellations
- * Enter date, time and use cursor keys to explore night sky
- * Comprehensive manual with colour foldout star map
- * Special integrated disc version available
- * BBC and ELECTRON Prices inc. P & P.

Cassette version

£9.95

5 1/2" disc version

£11.95



SMALL SCHOOL SOFTWARE,
Mail Order Department (M),
14, Saltmarsh Lane,
HAYLING ISLAND,
Hampshire PO11 0JT.

The Original "NEWARK" TV/RGB Monitor

It's a 14" remote control Grundig TV!!

ORIC ATMOS

(BBC/Acorn) (MSX)



(Electron)

It's an RGB computer monitor

It's £249.94 inc VAT - complete Package!!

It resolves 80 characters!!

QL (Almost)

The Package:

£249.94 for a remote control 14" TV with a computer lead - delivered to your door - including VAT

(We even fit a mains plug!) and carriage

We have a LARGE range of GRUNDIG models from 14" to 26" with or without Teletext.

Contact Elaine for an up to date leaflet package

NEWARK VIDEO CENTRE LTD

108 London Rd, Balderton, Newark, Notts.
Tel: 0636 71475 to order by Access or Visa. Mon-Sat/9am-6pm

NEW!

From Scarab Systems

Extender Board for BBC

UK's leading professionally produced software house for the Radio Amateur, has introduced a revolutionary and exciting new range. At the centre of this range is an extender board which can be fitted without disfiguring your keyboard, and is colour matched to your computer. Keyboard disfiguration will also lose your guarantee. There is no need for dismantling each time you need to fit a different ROM/EPROM and it provides external socket capability. There is also less chance of damaging your expensive ROM/EPROM thanks to a zero insertion release socket which is fully encapsulated.

With this easy-to-use extender, there is no need for expensive extra cartridge casings.

Free! Introductory gift

With each BBC extender board we are giving away a handy EPROM holder free of charge. The entire package is yours for only **£20.50**.

Watch out for exciting new additions to the range shortly.

Terminal Unit

As seen in the computer press. Decode and display radioteletype signals on your BBC using the Scarab MPTU-1 terminal unit. **£80.00** including software and connecting leads.

Essential literature

These books are packed with info and include a list of frequencies of most of the agencies in the world using RTTY.

World Press Services Frequencies **£5.00**

Guide to RTTY Frequencies **£9.00**



SCARAB SYSTEMS

Scarab Systems produce many other top-quality programs and equipment for the Radio Amateur. Use the coupon now for details.

39 Stafford Street, Gillingham, Kent ME7 5EN. Tel: (0634) 570441

All prices are inclusive of VAT and delivery and are correct at the time of going to press. Please send me

- BBC Extender board £20.50 plus free gift
- BBC Terminal Unit £80.00
- Free details of other equipment and programs
- World Press Services Frequencies £5.00
- Guide to RTTY £9.00

I enclose a cheque/postal order for

I wish to use my Access/Visa Card No.

Name

Address

Tel. No.

Signature

I understand that, if I am not fully satisfied, I can return the equipment with full reimbursement. 14 days delivery.

MU



VISA

What has the latest Electron User got for BBC Micro users? The answer's simple ... **LISTINGS!**

Pages and pages of them. Games, graphics demonstrations, utilities, they're all there. Also there are hardware reviews, hints and tips, regular features like Scrapbook and Notebook, Pete Bibby's beginners articles and the sound series.

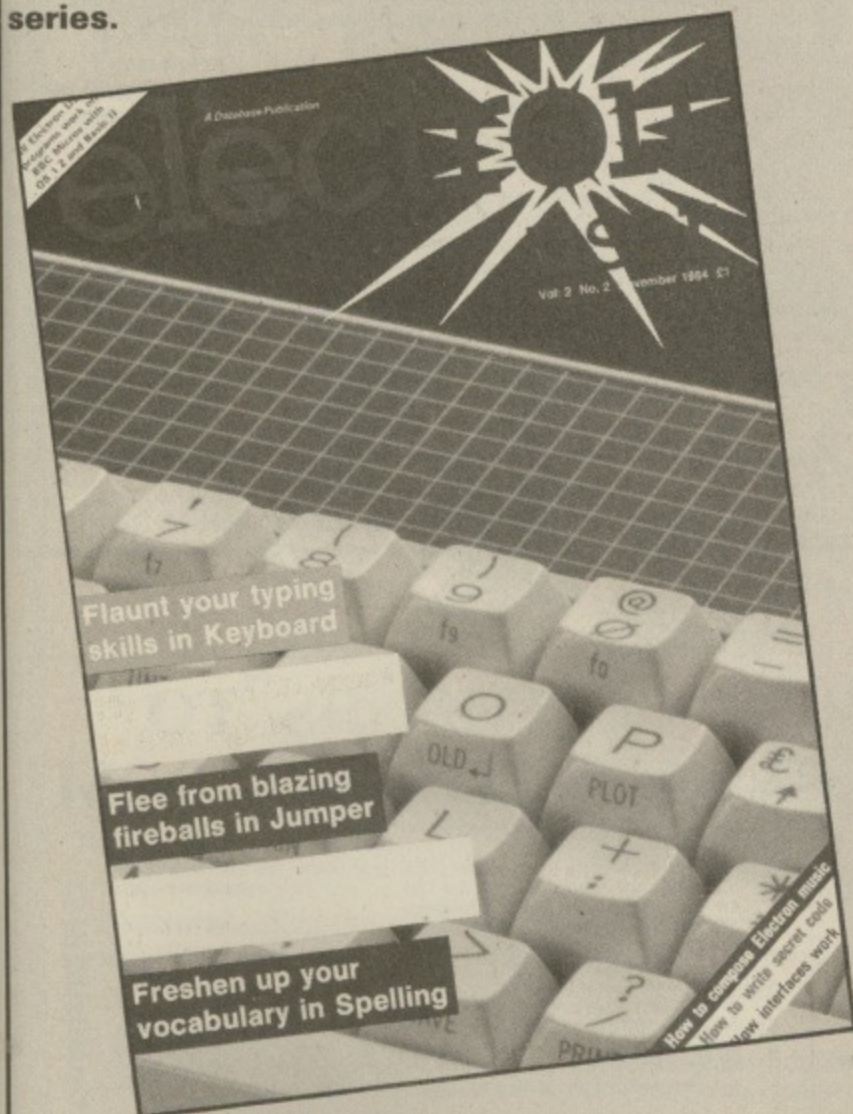

All Electron User listings will work on BBC Micros with OS 1.2 and Basic II. Even with Basic I machines and earlier OSs the vast majority of the programs will work without modification.

November sees the second in our series on taming the Electron's sound capabilities. For games freaks Roland Waddilove provides his Star Fighter while conservationists can blight the planners with Urban Sprawl. On the educational side there are programs to check out your spelling and help you learn your way around the keyboard. For hardware freaks there's an article on how joystick interfaces work while our reviewers tackle Slogger's ROM box and Mushroom's printer port. With beginners tackling arrays, a foray into Caesar Cipher and an assembly language wrap-around screen, it's the most interesting issue yet.

Now on sale at your newsagent!

OR perhaps a KAGA printer

*Free Cable!

*Free Paper!

FOR JUST £279

(This price is for model KP810)

KP910 - £389 INCLUSIVE OF VAT
(Please add £8 for post and packing)



The KP810 has an 8" printable width allowing 80 characters at 10c.p.i., and has a built in roll paper holder. £279.00 inc. The KP910 has a 15.6" printable width, giving up to 156 characters in standard pitch, and an enormous 265 characters per line in condensed mode. £389.00 inc.

The features include:

- *High speed printing: 160 characters per second
- *Bi-directional, logical seeking
- *Quiet operation: less than 60dB
- *High-resolution graphic printing: N x 16 dot matrix
- *Down loading for user-optional characters

- *4 character styles printable on the same line
- *Superscript and subscript available
- *International character sets selectable
- *Selectable line feeding: 1/8" and programmable
- *Handles; roll paper, fanfold, single sheet and multipart copy paper

HOW TO ORDER

To purchase the KP810 or the KP910 printer simply write your name and address on a piece of paper, and post to the address below, enclosing your cheque/P.O. made payable to Twillstar Computers Ltd. If you are a Credit Card Holder, simply use the telephone to place your order.



17 REGINA ROAD, SOUTHALL, MIDDLESEX UB2 5PL. TEL: (01) 574 5271



...ask for our Full range!



Twillstar Computers Limited

17 REGINA ROAD, SOUTHALL, MIDDLESEX UB2 5PL. TEL: (01) 574 5271

Open
6 days a week
9am to 7pm
Monday to Saturday



TELEPHONE ORDERS
(01) 574 5271



Expandable console for the BBC Micro

As supplied to Universities, Colleges, Schools, Business and Home Users.

Not just a monitor/tv stand but an expansion console which gives your micro the professional look. Protects and encloses your micro with room for disc drives and 2nd. processor or teletext adapter etc., all untidy connecting wires safely out of sight within the console. Made of light yet strong aluminium with a textured finish in matching BBC colour. Available now a bolt on extra module to the console for further expansion options. YES this console will grow with your needs.

Basic BBC console as shown £44.99 + £4 carriage.

Bolt on expansion module

£14.99 + £2 p&p

Free security bracket to educational users on request.

ELECTRON CONSOLE

The console will house the ELECTRON and will safely support the expansion interfaces which will plug into the rear of the micro and will support the VDU at eye level. Tidies up all wiring between the micro, cassette and VDU. The console stores the cassette and tapes and will allow space for drives at a later date.

Electron console as shown £34.99 + £3 p&p

Mail order only - viewing by appointment

Please add 15% VAT.

For further information or send cheque to:

Silent COMPUTERS

27 WYCOMBE ROAD, LONDON N17 9XN.
TEL: 01-801 3014 (24 Hr Ansaphone)

SPECIAL TORCH MODEL AVAILABLE: £46.99 + £4 carriage

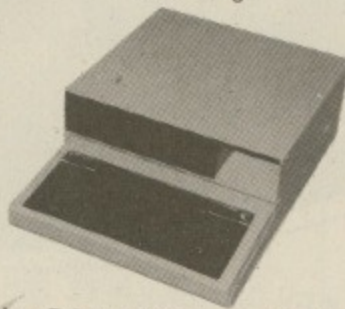

Matching Printer Stand, can double for VDU Stand over the micro - only £14.99 + £2 carriage

CONTEX

Professional Software for the BBC Computer

THE CONTEX SPREADSHEET

The ConTEX Spreadsheet is one of the most versatile spreadsheet programs available for your BBC computer. It will process virtually any financial or statistical column/row analysis calculations you care to give it. Prepare your home and office budgets, process accounts, complicated invoices, job costing, small stock control operations, financial and statistical modelling, expense evaluations, foreign exchange etc.

Command (? for help)			
	Jan	Feb	Mar
1 Car tax	75.00	0.00	0.00
2 Insure	0.00	150.00	0.00
3 Loan	150.00	150.00	150.00
4 Deprec.	100.00	100.00	100.00
5 Repairs	0.00	25.00	0.00
6 Maint.	0.00	0.00	56.00
7 Petrol	36.00	28.00	52.00
8 Oil	0.00	5.00	0.00
9 Other	12.00	3.00	3.00
10			
11 Total	373.00	458.00	261.00
12			
13 Mileage	500.00	400.00	850.00
14 MPG	30.33	29.12	29.75
15 Cost/mi	0.62	1.14	0.42

Loaded into your 32K RAM means there is no ROM to install (which will save multiple machine installations a small fortune!). Hundreds now in use. Compare the spec. this revised, enhanced version gives you:

Over 1,000 cells in upto 26 columns by 99 rows. Formulae, data or text into any cell. Individually variable widths (1-30 chrs) and decimal places for each column. Nine digit accuracy. Various printer format options. Row and column insert or delete with auto formulae adjust. Use all BBC functions, eg LOG, SIN, SQRT. Many new functions, eg. MAX, MIN, SUM, discount factor. Auto replicate formulae and data with auto adjust. Variables. Colour options. Save and restore to disc or tape. Four way scrolling. Headings stay on screen. Edit, search, help, model limits. Access to OS/DFS commands, eg. *DISC, *CAT. What-if modify command. Reference any cell by its id or by its headings. Full instruction booklet.

Cassette £9.99

Disc £12.99

TYPING TUTOR

Specifically designed for your BBC micro to teach and encourage you to fast touch typing. Professionally enhance your keyboard skills with the 90 smoothly graded lessons and the free format option. Hundreds in daily use and recommended by adult educational authorities this program will monitor your progress, intelligently check each line for errors and time you against the clock in words per minute. Optional audio key feedback, metronomic pacing and revised performance targets. Auto keyboard/finder display for all lessons including those special ones you optionally add to the course.

Cassette £9.99

Disc £11.99

Fast delivery. Discs supplied are 5 1/4" please specify if 40 or 80 track required.

CONTEX COMPUTING (B11)

15 Woodlands Close, Cople, Bedford MK44 3UE.



ADD 40 COMMANDS TO BBC BASIC WITH ONE ROM

GRAPHICS

SCALE is a powerful and totally flexible statement that allows the user to take control of the scaling of the screen. Integers, real numbers and variables can be used.

ROTATE is used to 'rotate' the axes about a point and by an angle both defined by the ROTATE statement on a scaled screen.

CIRCLE and **ELLIPSE** allow a multitude of shapes to be drawn using a single statement, including:- any regular polygon, circles, arcs, solid sectors, triangles, squares, etc.

FILL is used to 'fill' a previously drawn area, with CFILL setting the colour/pattern/shade within pre-drawn bounds.

TRANS is used to translate the scaled area across the screen by the use of cartesian co-ordinates, subsequent graphics commands making use of the now displaced scaled area.

Plus: SMOVE, SDRAW, SPLOT and UNSCALE.

4
IN
1

GENERAL

LLIST can be programmed, unlike LIST, and under the user's control, multiple statement lines can be split up into their component parts allowing for greater ease of reading.

LGOTO is similar to the GOTO statement but more powerful in that it enables the user to jump to 'labelled lines' allowing for neater and more readable programmes.

SORT allows the user to sort all or part of a string array into alphabetical order using single statement. Invaluable for data processing.

SETWIN and **WIN** allows the user to define, using SETWIN, and display, using WIN up to seven complete windows on the screen. The user being able to select and return to previously de-selected windows at will, the cursor maintaining its last used position within that window.

Plus: OPT, POPFOR, POPGOS, POPREP and ADDCOMM

Compatible with: Acorn DFS, Amcom(Pace) DFS, Watford DFS, Wordwise, Disc Doctor, Model B, BASIC 1 or 2, OS 1.20

ADDCOMM

Plus: *HELP displays the full syntax of all commands. Price includes a detailed ring-bound User Guide.

Now available for Electron with Rom board

LOGO

LMOVE is used to position the LOGO cursor, usually used prior to further LOGO statements.

ANGLE is used to set the intended direction of the LOGO cursor, the angle being described in degrees.

ADVANCE is used to move the cursor in the direction as set by ANGLE by the distance described in the ADVANCE statement.

TURN gives the cursor a new direction by turning it a certain number of degrees anti-clockwise from its previous direction.

PEN defines the kind of trail left by the LOGO turtle using the internal plot codes.

LCIRCLE and **LELLIPSE** are the LOGO equivalents of the similar enhanced graphics commands, the shape centre being the current LOGO cursor position.

LPOS is used to return the position of the LOGO cursor from a SCALED screen.

£28

includes VAT post and packing

See us on stand 62 Electron & BBC Show

FOOLKIT

CHAR is a simplified 'character' designing facility using an enlarged grid that enables the user to quickly and easily construct or alter graphic and pseudo-alphanumeric characters.

COMPACT is used to reduce the size of all or part of an existing program by intelligently appending lines together.

FIND is used to search all or part of a program to find any desired character or set of characters.

GREPL and **SREPL** are two related commands that enable the user to replace a character or group of characters with any other character or group of characters, under total control of user.

LVAR is used to list all, or alphabetically selected, variable names currently within memory.

VERIFY is a simple command to confirm that a copy to tape or disc is exactly the same as the original program in memory.

Plus: MEM, GOODPROG, KILLREM and FKEYS.

Available now from:

VINE MICROS, MARSHBOROUGH, SANDWICH, KENT. CT13 0PG.

(Or send stamp for Brochure.)



*It's the most popular program
we've ever produced!*

If you want to start doing more with your micro than just playing games, this package is your ideal introduction to the four most popular applications for professional computers. All the programs have been designed for simplicity, so even a child can use them. Yet they include advanced features not yet available on programs costing many times as much!



*Contains 32 page booklet giving clear,
easy-to-follow instructions on all 4 programs*

Word Processor: Ideal for writing letters and reports. There is a constant display of both time and word count, plus a words-per-minute display to encourage the budding typist! A unique feature is the double-size text option in both edit and printer mode – perfect for young children and people with poor vision.

Database: You use this for storing information, just like an office filing cabinet. Facts you have entered can be quickly retrieved by just keying in a word or part of a word. They can be sorted, replaced, saved for future use or printed out.

Spreadsheet: Enables use your micro for hor accounts or pocket m records. It creates a display of numbers in rows and columns. Continuous updating is possible, and a changed figure can be instantly reflected throughout the rest of the spreadsheet. Your results can be saved, to be used for future updates, or can be fed into its associated program.

Graphics: Part of the spreadsheet section, it lets you draw bar charts, pie charts and histograms to give a graphic presentation of your statistics. Helps to give life and colour to the dullest figures!

- ☆ Word Processor
- ☆ Spreadsheet
- ☆ Database
- ☆ Graphics

**Now they're
all together -
in ONE simple
package**

Use the special order form on Page 7 – No stamp needed!

MicroSac – the tailor-made carrying bag for your BBC Micro

Lots of space for all your equipment – sturdy foam-padded design – easy to carry.



**ONLY
£19.95**

Your BBC Micro needs protecting!

Our luxury dust cover is made of soft pliable water-resistant transparent vinyl, bound with strong cotton and decorated with the *Micro User* logo in black.



**ONLY
£3.95**

Keep your copies neat and complete

These handsome binders are bound in PVC with the *Micro User* logo in gold blocking on the spine.



**ONLY
£3.95
(UK)**

Don't miss our two specials...



The Micro User Education Special – No. 1

Packed with practical programs which teachers can use in the classroom and parents can use to teach children at home. Mathematics, language, shape recognition, coordinates, drawing, and geometry are just some of the subjects covered by programs that will fascinate children of all ages, from early learners to secondary pupils.

PLUS the most detailed guide available to all the educational software that has been provided for the BBC Micro. All programs are alphabetically listed and described.

Now on sale from newsagents or use the order form on Page 7.

Coming soon...

The Micro User Games Special – No. 1

£1.95 each

An Aladdin's cave of really outstanding programs that will delight every BBC Micro enthusiast. It contains 12 great games – all original and all fully listed. Arcade games, card games, strategy games and sports simulations – they're all there.

PLUS a unique A to Z guide to all the games software currently available for the BBC Micro. Something you will want to keep and refer to again and again in the months to come.

At your newsagents from October 26.

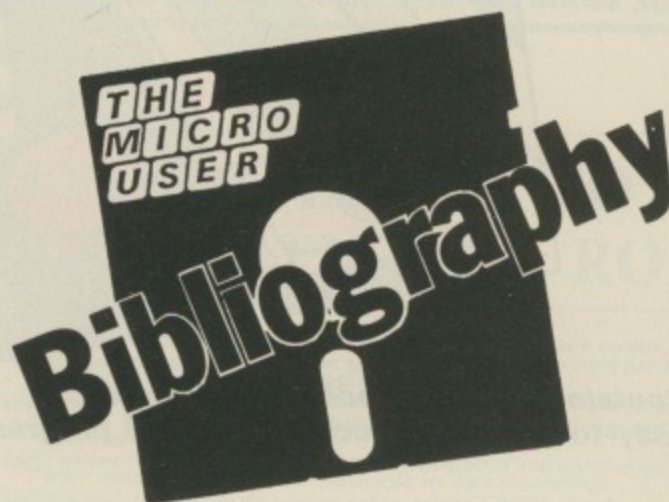

TIRED of spending hours searching your back issues for that article on interfacing? Sick of thumbing endless dog-eared pages for that hint on reprogramming the Break key? You know it's there somewhere – but where? Does tracking down a program remind you of an adventure game?

It's about time you let your BBC Micro do the donkey work for you. Why waste precious programming time searching for an elusive reference?

Now help is at hand – in the form of the *Micro User Bibliography*.

This long-awaited database, developed for us by Jim McHugh, contains over 1,000 references from 18 editions of *The Micro User* (March 1983 to August 1984). It covers:

- games ● reviews
- educational utilities
- peripherals ● books

and much much more. All the accumulated wit and wisdom of *The Micro User* is indexed to make life easier for you.

For instance, if you want to know where and when we talked about ENVELOPE just use the *Micro User Bibliography*. It will recall every occasion we wrote about this subject and tell you which pages to turn to.

The disc based utility contains an option to search for one or two strings and will complete the task in a maximum of 45 seconds. Alternatively you can view the whole *Bibliography* at your leisure. You can even generate hard copy if you need it.

So stop wasting your time searching and use *The Micro User Bibliography* to make the fullest use of your back issues.

Tap the power of The Micro User... bring your back issues to life!

A Magical Adventure for the very young!



Based on the style of the classic computer adventures – but written so that even small children can learn to find their way around, encouraged by colourful graphics and exciting sound effects.

The pack contains a 48-page full colour storybook **PLUS** a full length multi-location adventure on cassette for only

£8.95! post free

Read the book – then play the game!



Ideal Christmas present

CHRISTMAS CRACKERS

It's the games cassette every BBC Micro user will want to find in his Christmas stocking!

21 easy to play programs with an exciting festive theme!

OUR cracking Christmas cassette contains games galore for all the family. Young or old, computer freak or novice – there's something here for everyone. There are 21 games for just **£5.95** (cassette) or **£7.95** (disc) – the best buy you'll make all Christmas!



Use the special order form on Page 7 – No stamp needed!

THE BEEB BODY BUILDING PACKS

Upgrade your BBC Micro with these Beeb Body Building Packs.

- **Packs 1 and 2:** These packs let you safely and simply interface your micro to the outside world.
- **Pack 3:** Give your Micro data-processing muscle by building a dual cassette system.
- **Packs 4 and 5:** Control mains equipment in complete electrical isolation. Pack 4 is rated at 4 amps, pack 5 at 10 amps.
- **Pack 6:** All the components for the Micro User light pen.
- **Pack 7:** Experiments to investigate pendulum behaviour and capacitor discharge.
- **Pack 8:** A versatile sound to pattern converter with many applications.
- **Pack 9:** Remember all those vital appointments with the help of this real time clock.
- **Pack 10:** A high speed A/D with many applications. For instance, turn your microcomputer into an oscilloscope!
- **Pack 11:** A pulse rate monitor. Ideal for keep-fit fanatics and experimenters alike.
- **Packs 12 and 13:** Components to control stepping motors in two different ways. Pack 12 uses the micro to control the stepping sequence. Pack 13 uses a dedicated chip.
- **Pack 14:** Turn your micro into a communications terminal by building an acoustically coupled modem. (Handset retainer not included.)
- **Pack 15:** Add the tremendous power of 4 extra User Ports to your BBC Micro.
- **Pack 16:** The ribbon cable and socket needed for pack 15.
- **Pack 17:** All you need to make a digital to analogue converter (programmable as a waveform synthesiser). You'll also need a ribbon cable (such as in pack 2).

Also available are a fully-assembled light pen, sound-to-pattern converter, real time clock, pulse monitor and digital to analogue converter. For a small extra charge constructors who run into difficulty assembling pack 8 can send it in for testing. It will be returned fully operational.

Plug your BBC Micro into the world!

AS Microweb has successfully proved, communications is the fastest growing field in microcomputing, and we want YOU to be involved.

So we're offering a unique starter pack — the superbly designed Commstar/Nightingale combination from Pace. And it costs just £139.95.

Commstar will turn your micro into a versatile terminal that will allow you to access other micros, mainframes, viewdata systems and bulletin boards — including Microweb and Prestel. The modem is ideal



for making use of Commstar's many exciting facilities, and with its push button controls it couldn't be easier to use.

At the *Micro User* we're very impressed with this matched pair, and we're sure you will be too.

£139.95
Complete



The Advanced User Guide is the essential companion for the BBC Micro... with 512 information-packed pages

The essential companion for the BBC Micro.

Featured in its 512 pages are:

- ★ the BASIC Assembler
- ★ 6502 machine code reference section
- ★ complete descriptions of all FX calls
- ★ BBC memory usage and vectors explained
- ★ full interfacing details for the user port, tube, analogue port, 1 MHz bus
- ★ paged ROMs explained
- ★ and lots, lots more.

With many examples to illustrate the text, this guide is the indispensable reference work for the serious BBC Micro programmer.

£11.50



Assembly Programming Made Easy puts the magic world of machine code at your finger-tips

Here is a really easy guide for the enthusiastic beginner to assembly language for the BBC Micro. Using easy examples, cartoons and short, very simple programs you will quickly learn how to put graphics on the screen, use the BBC operating system and bring the machine to life.

£5.95

To make learning assembly language even easier send for the combined book and tape cassette containing all the programs.

£12.95

ACTION REPLAY!

Build your own handy, action-packed cassette library of these all-time Micro User favourites. Only £3.75 per cassette (three games in each).

ACTION REPLAY No. 1:

Deathwatch Hold the fort against a combined tank and helicopter assault on your positions. Fast and furious — one of our most popular games. **Pelmanism** Defeat the computer by remembering more pairs of cards than it can. **King Kong** Use your helicopter to rescue two maidens from the Empire State building — avoiding a deluge of rocks from King Kong.

ACTION REPLAY No. 2:

Fruities Fast-paced, fun-packed extravaganza. Guide your man up ladders, avoiding — and digging traps for — the marauding Fruities! **Nim** Find out just how nimble your mind is in this intriguing battle of wits against the computer. **Space Pilot** Desperately fighting off hostile life-forms, you must dock with satellites to replenish dwindling fuel supplies.

ACTION REPLAY No. 3:

Robin and Marian Medieval melodrama! Rescue Maid Marian from the Sheriff. A hilarious, action-packed game. **EECGAL** in charge of the EEC's Picture Gallery, you have to put some order into the frames — but it's not so simple as it sounds. **Air Strike** You need to fly fast and low for this dangerous intrusion into enemy air space.

ACTION REPLAY No. 4:

Barrel Battles Fast and furious video action. Dodging an avalanche of deadly barrels you climb towards the telephone. **Frogs 'N' Dogs** Loved by young and old alike. Simply take Freddy Frog for a walk, avoiding Fido and poisonous lilies! **Tenpins** Stunning simulation of ten pin bowling. This addictive game will hold you spellbound.

ACTION REPLAY No. 5:

Tower of London Ghosts have broken out of the Tower of London and taken the treasure. Can you recover it? **Blackjack A** true-to-life recreation of the casino favourite. Can you beat the bank? **Galactic Invaders** The only thing between you and imminent destruction by waves of hostile aliens is your proton gun. A compulsive classic.

ACTION REPLAY No. 6:

Alien Intruders Stunning version of the all-time arcade hit. No one can resist this classic! **Goblins Frolics** in fairyland! Guide Kaplan the pixie home through the forests, avoiding the nasty goblins — a delightful game. **Gone Fishing** Superb simulation of a day on the riverside. This enthralling program will give hours of enjoyment.

*Go for gold
with the...*

MICRO
OLYMPICS

**11 great track
and field events
for only . . .**

£5.95

YOU are challenged to beat the Olympic world records – with the packed stadium cheering you on to victory . . . or defeat!

Just like the real thing, you'll want to keep on improving your skill until you're up there among the greats!

MICRO OLYMPICS is more than a game. It's a brilliantly written collection of ELEVEN track and field events.

And because they're selling in their thousands we've been able to bring the price right down – to just £5.95.

Ever imagined yourself as another Seb Coe? Then try to run against the world record holder at



1500 metres. And if that distance is too much for you then there's always the 100, 200, 400 and 800 metres to have a go at.

Not much good at running? Don't worry, MICRO OLYMPICS has many more challenges for you. Why not try your skill at the high jump or the long jump?

And if you can't beat the computer at running or jumping then you can always throw things around in frustration! The trouble

is that it's just as hard to be a champion at the discus, the hammer or the javelin.

And the pole vault takes the event to new heights!

Yes, it's fast, furious fun, pitting yourself against the world's best times and distances on your micro.

You may not be another Steve Ovett or Alan Wells, but with practice you COULD become the Micro Olympics Champion!



What a bargain!

**Four classic arcade games
for less than £1.50 each**

ALIEN INTRUDERS – With only your laser for protection you must destroy the waves of aliens who threaten to engulf you. **PANZER ATTACK** – You are a tank commander engaged in vicious combat against encircling enemy forces. **SNAPMAN** – Guide your man through the maze as he munches energy pellets

and avoids hostile aliens. **MAYDAY** – A futuristic adventure! As captain of an interstellar cruiser you must guide the sole survivor of a stricken space freighter through the wreckage of his craft.

£5.95 (cassette) **£7.95** (disc).

Use the special order form on Page 7 – No stamp needed!

ALL the programs from The Micro User from Day One are now on tape and disc!



MARCH 1983: Deathwatch, a superb arcade game Bingo, clever uses of the randomise function; Bubblesort routines; Tests function keys in machine code. 0.1 Colour and Graphics Routines: create a kaleidoscope of screen designs.

APRIL: King Kong, rescue girls from the Empire State Building before killing Kong. Nim, a structural game of strategy. Tokens, unravel the Basic ROM; Formatter, an essential disc utility; Disassem, a full machine code disassembler.

MAY: Air Strike, a fast and furious arcade game; Test your mental powers with Pelmanism; Anagrams, the word game. Character, generate vertical and inverted text. Teletext, animation in Mode 7. Beeb, two joystick exercises.

JUNE: Space Pilot, lost in space you must fight off repeated attacks from alien life forms. Nomism, you are a nomadic herdsman desperately trying to eke out a living on the plains of Africa. Colourful Characters Plus other listings from the June issue.

JULY: Tenpin, a simulation of Tenpin Bowling; Spacepods, beat the alien hordes; Cup, exciting 3D graphics techniques Test and Steady, programs to accompany the Beeb Body Building Course. Breakfix, don't let Break destroy your precious variables!

AUGUST: Fruities, driven by strange urges you climb the ladders of adventure to risk all in the gardens of unearthly frights. Animation, a suite of programs that really bring your screen alive; Casdisc, the machine code downloader for your disc system; Mode 7 colour routines.

SEPTEMBER: Robin & Marian, rescue Maid Marian from the Sheriff of Nottingham. Galactic Invaders, an exciting arcade game. DFS Benchmarks, 14 DFS test programs. Animation, new techniques. Terminal, connect a BBC Micro to a mainframe.

All our discs incorporate an automatic downloader. Just boot up the disc, make a choice from the menu - and away you go!

Save wear on your fingers and ensure all your programs are error-free by using our monthly tapes or discs. They are only:
£3.75 cassette
£5.75 disc
You can also take out a year's subscription and have them posted to you each month. The cost is £40 (cassette) and £60 (disc).

OCTOBER: Fishing, a compulsive day's angling. Joykey, convert programs to joystick. Pentest and Bellringer, for Micro User lightpens. Contours, an educational program. Link BBC Micros to each other. Plus all the listings from the first Electron User.

NOVEMBER: Goblins, an enchanted journey. Blackjack, the casino favourite. Charge and Pendulum, Body Building Course part 9. Sideways, programs in ROMs. Pendraw, a light pen sketching program. Plus all the programs from the second Electron User.

DECEMBER: Tower, rescue London's treasure. Santa, help Father Christmas. VDU 23, an invaluable character defining utility. Paged, graphic techniques. Plus all the listings from the third issue of Electron User.

JANUARY 1984: Barrels, an all-action arcade game. Noteplay, an entertaining musical utility. Dump1 and Dump2, multitone screen dumps. All the programs from our Sound, Beginners and Graphics articles Plus 12 programs from the fourth Electron User.

FEBRUARY: Invasion, the classic arcade game. Frogs, fun for all the family. Engvgen, a logic game. Balance, a number learning program. Key, single key entry for the BBC Micro Plus nine other programs from The Micro User.

MARCH: Mazemunch, block-busting arcade action. Birthday, family fun for our anniversary. Derrick, number fun for infants. Pixelpen, high resolution for lightpens.

APRIL: Microgolf, the simulation. Eastermaze and April Fool, seasonal games. Seawall and Magic Square, maths fun. Filer and Album, a database of sounds. TRX1, TRX2, RS243 driver. Heartrate, monitor your fitness.

MAY: Dug Dig, asteroid adventures. Damraider, naval action. Envaidd, easy envelopes. Steppers, Body Building motor control. Spiro, graphics windows. Adventure, a trapdoor maze. Renumber, program utility. Bigletter, large type. Memory, RAM efficiency.

JUNE: Roadracer, 3D driving action. Quadline, four-in-a-line logic game. Monitor, machine code debugging routines. Toolkit, 8271 disc controller explored. Areas, easy maths. Spell, spelling education.

JULY: Doomrun, deep space drama. Backgammon, the classic board game. Keys, user defined key editor. Save? and Tidisk, disc utilities. Alice1 and Alice2, mini-adventures. Terminal1 and Terminal2, two communication programs. Acoustic, software for the Body Build Modem.

AUGUST: Castle, an enthralling adventure program. Gridman, a high speed game of strategy. Tedit, a superb Teletext editor. Dsquare, simple number fun. Dedit, a versatile disc editor. Input, the ultimate general input routine. Bells, Alice's mini-adventure.

SEPTEMBER: Villains, save your crystals from the evil onslaught. Rollerball, an intriguing game of strategy and agility. Microterm, communications terminal software. T/Textdump, high quality Mode 7 screen dump. Numbersign, simple number skills test for infants. Fmeter, four body building programs.

OCTOBER: Wampus, the labyrinth and slay the beast. Balloon, brave the caves, escape the Goulogs. Splits, split screen utility. Pageram, paged RAM programs. Input1/2, alternative inputs for the disabled. Morecol, extend the colour palette. D/A, a wave form generator. Integer, direct addressing speed.

NOVEMBER: Buster, can you line up the diamond blocks? Duel, compulsive two player action. Seaside, picture fun for the young reader. M7letters, teletext large letters utility. Dsload, loading large disc files to &E00. 6502, three second processor programs. Synth, two musical Body Building programs.

Special Offers!
● Any five of our monthly tapes for only £15.
● All 10 tapes from the 1983 issues for only £25.



ALL BACK ISSUES OF THE MICRO USER ARE STILL AVAILABLE - USE THIS COUPON

Unless otherwise indicated all prices include postage, packing and VAT, and are valid until November 30, 1984

Please tick items required in box below: £ p

Micro User back issues

March 1983 £1 <input type="checkbox"/>	Jan 1984 £1 <input type="checkbox"/>
April 1983 £1 <input type="checkbox"/>	Feb 1984 £1 <input type="checkbox"/>
May 1983 £1 <input type="checkbox"/>	Mar 1984 £1 <input type="checkbox"/>
June 1983 £1 <input type="checkbox"/>	Apr 1984 £1 <input type="checkbox"/>
July 1983 £1 <input type="checkbox"/>	May 1984 £1 <input type="checkbox"/>
Aug 1983 £1 <input type="checkbox"/>	June 1984 £1 <input type="checkbox"/>
Sept 1983 £1 <input type="checkbox"/>	July 1984 £1 <input type="checkbox"/>
Oct 1983 £1 <input type="checkbox"/>	Aug 1984 £1.25 <input type="checkbox"/>
Nov 1983 £1 <input type="checkbox"/>	Sept 1984 £1.25 <input type="checkbox"/>
Dec 1983 £1 <input type="checkbox"/>	Oct 1984 £1.25 <input type="checkbox"/>
	Nov 1984 £1.25 <input type="checkbox"/>

UK. Add postage 50p per copy (6 or more £2.50)
 Overseas (surface mail) Add postage 75p per copy (6 or more £4.50)

Airmail prices on application.

Single copies of cassettes/discs*

£3.75 - Tape (UK & Overseas)

£5.75 - Disc (UK & Overseas)

Deathwatch	Mar 1983	<input type="checkbox"/>
King Kong	Apr 1983	<input type="checkbox"/>
Air Strike	May 1983	<input type="checkbox"/>
Space Pilot	Jun 1983	<input type="checkbox"/>
Tenpin	Jul 1983	<input type="checkbox"/>
Fruities	Aug 1983	<input type="checkbox"/>
Robin & Marian	Sep 1983	<input type="checkbox"/>
Gone Fishin'	Oct 1983	<input type="checkbox"/>
Blackjack/Goblins	Nov 1983	<input type="checkbox"/>
Tower Bridge	Dec 1983	<input type="checkbox"/>
Barrel Battle	Jan 1984	<input type="checkbox"/>
Alien Invasion	Feb 1984	<input type="checkbox"/>
Mazemunch	Mar 1984	<input type="checkbox"/>
Microgolf	Apr 1984	<input type="checkbox"/>
Damraiders	May 1984	<input type="checkbox"/>
Road Racer	Jun 1984	<input type="checkbox"/>
Doomrun/Backgammon	Jul 1984	<input type="checkbox"/>
Castles of Fear	Aug 1984	<input type="checkbox"/>
Villains	Set 1984	<input type="checkbox"/>
Hunt the Wampus	Oct 1984	<input type="checkbox"/>
Blockbuster/Duel	Nov 1984	<input type="checkbox"/>

*Please indicate disc format:

- 40 track
 80 track

Micro User annual subscription

UK £15
 EIRE £15 (Sterling)
 Surface mail - Rest of world £20
 Air mail - Rest of world £65
 Tick box if renewal Commence with issue TOTAL

Annual subscription for cassettes and discs

BBC 'B' cassette £40
 BBC 40 track disc £60
 BBC 80 track disc £60
 Commence with (state month) TOTAL

Magic Sword

Book and cassette £8.95
 TOTAL

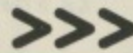

Dust Covers

£3.95
 (UK & Overseas) TOTAL

Binders

UK - £3.95
 Overseas - £5.00
 TOTAL

The Micro User Bibliography

BBC 40-track disc £7.95
 BBC 80-track disc £7.95
 TOTAL

MicroSac

£19.95
 TOTAL

Communications package

£139.95
 TOTAL

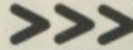

Beeb Body Building Packs

Described in issue

Pack 1	July 1983 page 83	£9.95	<input type="checkbox"/>
Pack 2	July 1983 page 83	£9.95	<input type="checkbox"/>
Pack 3	August 1983 page 85	£9.95	<input type="checkbox"/>
Pack 4	Sept 1983 page 91	£9.95	<input type="checkbox"/>
Pack 5	Sept 1983 page 91	£12.95	<input type="checkbox"/>
Pack 6	October 1983 page 69	£13.65	<input type="checkbox"/>
Pack 7	November 1983 page 71	£15.50	<input type="checkbox"/>
Pack 8	December 1983 page 95	£16.55	<input type="checkbox"/>
Pack 9	February 1984 page 123	£28.50	<input type="checkbox"/>
Pack 10	March 1984 page 132	£24.95	<input type="checkbox"/>
Pack 11	April 1984 page 118	£19.00	<input type="checkbox"/>
Pack 12	May 1984 page 148	£24.95	<input type="checkbox"/>
Pack 13	May 1984 page 148	£29.45	<input type="checkbox"/>
Pack 14	July 1984 page 115	£59.95	<input type="checkbox"/>
Pack 15	August 1984 page 117	£44.95	<input type="checkbox"/>
Pack 16	August 1984 page 117	£8.25	<input type="checkbox"/>
Pack 17	October 1984 page 149	£20.85	<input type="checkbox"/>
Assembled light pen		£18.35	<input type="checkbox"/>
Assembled sound to pattern converter		£22.30	<input type="checkbox"/>
Assembled real time clock		£31.00	<input type="checkbox"/>
Testing sound to pattern converter		£9.70	<input type="checkbox"/>
Assembled pulse monitor		£25.50	<input type="checkbox"/>
Assembled digital to analogue converter		£26.85	<input type="checkbox"/>

Add £1 p&p (FREE if more than one pack ordered)

Mini Office

BBC 'B' cassette £5.95
 Electron cassette £5.95
 BBC 40-track disc £7.95
 BBC 80-track disc £7.95
 TOTAL

Micro Olympics

BBC 'B' cassette £5.95
 Electron cassette £5.95
 BBC 40-track disc £7.95
 BBC 80-track disc £7.95
 TOTAL

Action Replay

BBC 'B' cassette £3.75
 Ring Nos. required 1 2 3 4 5 6 (All six for £18) TOTAL

The Advanced User Guide

£11.50
 TOTAL

Games Special - No. 1

£1.95

Education Special - No. 1

£1.95
 TOTAL

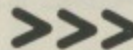

Payment: please indicate method (✓)

- Access/Mastercharge/Eurocard
 Barclaycard/Visa

Card No.

Cheque/PO made payable to Database Publications Ltd.

Name

Address

Signed

Classic Arcade Games

BBC 'B' cassette £5.95
 BBC 40-track disc £7.95
 BBC 80-track disc £7.95
 Electron cassette £5.95
 TOTAL

Assembly Programming

Book only £5.95
 Book and cassette £12.95
 TOTAL

Christmas Crackers

BBC 'B' cassette £5.95
 BBC 40/80 disc £7.95
 40 track 80 track TOTAL

Detach this complete page and mail as indicated on the reverse.

Please allow up to 28 days for delivery.

TOTAL

**You can also order
by phone or Prestel**

Any of the goods listed here can
be ordered by telephone.
Micronet subscribers and other
users of Prestel can also use the
Prestel Mailbox.

Phone orders:

061-480 0171

9am-5pm

Prestel Mailbox

Key Page 77, then send your order to:

614568383

24 hours

*Don't forget to quote your
credit card number AND
your full address.*

**The Micro User,
FREEPOST,
Europa House,
68 Chester Road,
Hazel Grove,
Stockport SK7 5NY.**

**NO
POSTAGE
NEEDED
(IF POSTED IN UK)**

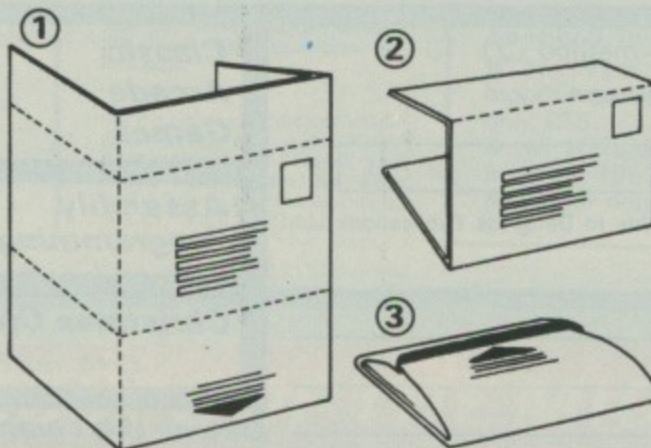

TUCK INTO FLAP

**HAVE YOUR INCLUDED YOUR CHEQUE
— or given your credit card number?**

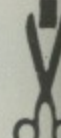

INTRODUCTORY PRICES FOR BEEB USERS

NO EXTRA FOR UK VAT OR POSTAGE!

CATALOGUE DISC. Make a catalogue disc of the menu pages (available only from discs utilising the MENU disc program) or filename directory pages (from any standard disc). Once created, auto booting will enable you to look through all the pages catalogued and see exactly what you have on each disc. It is very simple to add, alter, or delete catalogue pages. This disc is essential if you are to keep track of all your discs and their contents. An ideal complement to the MENU disc.
CATALOGUE DISC (state 40 or 80 track) **£8.00**

MENU DISC. Make all your discs menu driven. Sort out your files at last with this disc which enables files to be run at the touch of a single key. Simplicity itself to create/amend/delete the menu of your choice. Ideal when inexperienced operators or young children need to use the computer. May be copied for your own use with all your own discs.
MENU DISC (state 40 or 80 track) **£8.00**

SWITCHED MAINS SOCKET. Control mains powered equipment using this low cost range of computer switched mains sockets connected to the user port. Up to 8 mains sockets can be controlled independently using simple basic or machine code programmes. Central control of electrical appliances is a simple, practical and economic possibility within the home, research establishment and industry, to control most electrical appliances for hobby, security, energy management, process control etc. Each switch incorporates a 10A relay to give inexpensive high power control, and is available in single or double (independently switched) versions.

SWITCHED MAINS SOCKET, 10A SINGLE **£23.00**

SWITCHED MAINS SOCKET, 10A DOUBLE **£29.00**

USER PORT CABLE **£6.00**

VARIABLE POWER MAINS SOCKET. This series of mains sockets is similar to the SWITCHED series, with the additional feature that it utilises a 3A solid state switch suitable for control of most low power appliances. Being solid state, the unit may be switched very rapidly under software control to vary the average power delivered to the load, as is standard practice in lamp dimmers and motor speed controllers.

VARIABLE POWER MAINS SOCKET, 3A SINGLE **£26.00**

VARIABLE POWER MAINS SOCKET, 3A DOUBLE **£37.00**

NORMALLY 'ON' SOCKETS. Both the SWITCHED and VARIABLE SOCKETS can be modified to be 'normally on' ie 'on' until the computer is connected and programmed to turn the switch 'off'. This version is especially useful when appliances are to be used without the computer yet need to be controlled from time to time, eg domestic lights for home security.

OPTION FOR 'NORMALLY ON' CONFIGURATION **50p**

USER PORT INTERFACE BOARD. Interface and control or monitor external circuits for hobby, home security, process control etc. Invaluable as a software development aid since LEDs indicate the status of all 8 I/O lines and both control lines. DIL switches can simulate all inputs and invert all outputs. Separate terminal blocks for input and output logic connections and BEEB's own 5V supply. Optional relays can be fitted to each of the 8 output lines.

USER PORT INTERFACE BOARD **£29.00**

INTERCONNECTING CABLE (to user port) **£8.00**

OPTIONAL RELAY (fitted) **£2.00**

KEYBOARD COVER. Rigid moulded cover fits only over the keyboard and speaker sections, so may be used easily even when the computer is installed with only the keyboard area accessible. Protects against dust and accidental damage.

KEYBOARD COVER **£7.00**

COMPUTER COVER. Superior fitted black leatherette cover to protect your computer, available either plain or personalised with your own name or initials.

COMPUTER COVER (plain) **£5.50**

PERSONALISING (per letter) **50p**



ELECTROLINK LTD

**FREEPOST, Church Crookham, Aldershot
Hants GU13 0BR.**

Tel: 02514 4332 or 0252 543095

Order now, or ask for our free data sheet with further details on these and other products.

LOTHLORIEN

56A PARK LANE, POYNTON, CHESHIRE
Telephone: 0625 876642



CONFRONTATION

Build-on game that offers a basic format for any modern, non-nuclear conflict. Contains a modern European scenario with facility to create others of your choice using air and land forces. Two-player game.

BBC B

£7.95

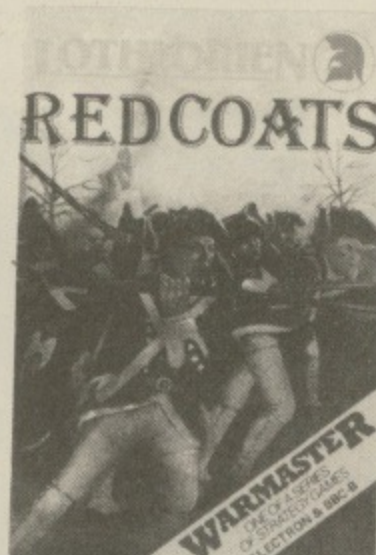

REDCOATS

Redcoats is an ALL GRAPHIC wargame for either 1 or 2 players. Set during the American war of independence the game contains 5 different battle scenarios and the facility to create your own.

Electron/BBC B

£6.95

NEW TO ENHANCE THE MASTER PROGRAM

Confrontation Scenarios Vol. I

£5.95

Confrontation Scenarios Vol. II

£5.95



JOHNNY REB

There's still plenty of fight left in the Confederate South as each side selects forces to manoeuvre on a full-graphics battlefield. Play against the computer or challenge a friend.

Electron/BBC B

£6.95

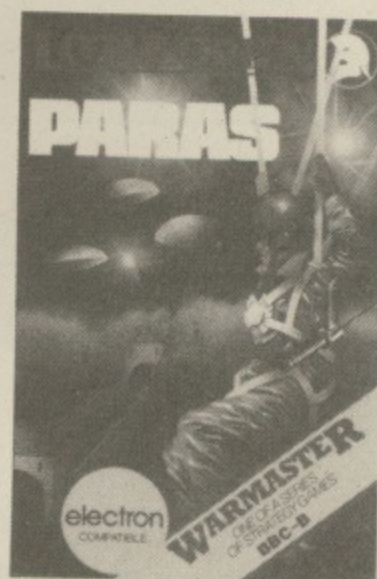

PARAS

Dramatic all-graphics campaign. Your hand-picked force has dropped behind enemy lines to capture a strategic river crossing. Two versions of the game with ten levels of play.

Electron/BBC B

£6.95

Games to suit all tastes. Action, excitement and plenty to think about.

Confrontation BBC B only	£7.95	Scenarios Vol. II	£5.95
Redcoats. Electron/BBC	£6.95	Battlezone. Electron/BBC	£6.95
Johnny Reb. Electron/BBC	£6.95	The Stolen Lamp. Electron/BBC	ONLY £2.99
Paras. Electron/BBC	£6.95	graphic adventure game	
Scenarios Vol. I	£5.95		

Free colour catalogue listing all Lothlorien games

I enclose a cheque/P.O. for £ _____ made payable to M C Lothlorien.

Please debit my Access No. _____ Signed _____

Name _____

Address _____

Send to: M C Lothlorien, 56a Park Lane,
Poynton, Cheshire SK12 1AE.

Tel: Poynton (0625) 876642.



Ref: MU/A1.

UK's LOWEST PRINTER PRICES!



PRINTERLAND



ORDERED TODAY - DELIVERED TOMORROW

FREE manual with every printer explains fully how to interface and pass control codes from your BBC to Epson compatible printers, includes multi mode screen dumps plus much more.

DOT-MATRIX

EPSON RX 80	£189.95
EPSON RX 80 F/T	£219.00
EPSON RX100	£329.00
EPSON FX 80	£317.00
EPSON FX100	£425.00

DOT MATRIX PLUS NEAR-LETTER QUALITY

CANON PW1080A	£249.00
---------------	---------

DAISY-WHEEL

JUKI 6100	£325.00
EPSON DX100	£356.00

ACCESSORIES

WORDWISE	£32.00
PAPER (2000 Sheets)	£12.00
BBC/PRINTER CABLE	£10.95

COPYALL DISK

- Copies ALL protected disks inc. tape to disk utilities.
 - Best on the market
 - Copies from original to your blank disk
- £10.25**

Educational, G'ment plus O'seas Orders Welcome

Please add 15% VAT. Delivery Printers £10.00. Paper £3.00. Other 50p
Printerland, Unit 27, Estate Buildings, Railway St., Huddersfield HD1 1JP

TEL (0484) 514105 Showroom Open Mon-Fri 9.15-5pm.
Showroom Open Sat Morn 9.15-12.30pm.



MICROMAN Computers

ACORN SPECIALIST COMPUTER CENTRE

ACORN/BBC COMPUTERS:

Acorn Electron	199.00
Electron Plus One	59.95
BBC Model B	399.00
BBC Model B + DFS	469.00
Acorn Teletext Receiver	225.00
Acorn 6502 2nd Processor	199.00
Acorn Z80 2nd Processor	399.00
Acorn IEEE Interface	325.00
Bitstick	375.00

BBC UPGRADES:

A-B Upgrade (Fitted)	95.00
DFS Interface (Fitted)	P.O.A.
Speech Synthesizer (Fitted)	55.00
Opus D/D DFS	129.95

PRINTERS:

Epson RX80FT	295.00
Epson FX100	574.95
Star Gemini 10X	268.00
Star Delta 10	385.00
Cannon PW-1080A	330.00
Shinwa CP80	220.00
Juki Daisywheel Printer	399.00

TORCH COMPUTERS:

Z80 Disc Pack	799.00
Z80 2nd Processor Card	339.00
Graduate	POA

BBC FIRMWARE:

View ROM	59.80
Wordwise ROM	44.85
Viewsheet ROM	59.80
B-Base Database Disc	25.00
Ultracalc Spreadsheet ROM	74.
Computer Concepts from	33.35
Toolstar ROM	34.00
Commstar EPROM	34.00
BCPL ROM	99.65
Sidewise ROM	44.70
Solidisk 32K Sideways RAM	57.95
Solidisk 96K Extension	92.00
Solidisk 128K Sideways RAM	149.95
Aries B20 RAM Board	79.95
Gemini Datagem	129.00

MODEMS:

Grapevine and Telemod	
Modems	P.O.A.

MONITORS:

Decca RGB Standard	228.85
Microvitec Cub Standard	228.85
Zenith Green	109.25
Decca TV/Monitor	265.00

DISC DRIVES:

Full range available	POA
----------------------	-----

GEMINI INTEGRATED SOFTWARE
NOW IN STOCK

WE HAVE A RANGE OF BUSINESS & WORD
PROCESSING PACKAGES BASED AROUND THE BBC
& TORCH COMPUTERS

ACORN APPROVED SERVICE CENTRE
Our workshop offers a comprehensive service including
Repairs and Upgrades by our own engineers

EDUCATIONAL & INDUSTRIAL ENQUIRIES WELCOME

PLEASE PHONE FOR OUR PRICE LIST



All prices include VAT, Post & Packing £9 (Large items) £1 (Small items ROM's etc)



RAINFORD INDUSTRIAL ESTATE, MILL LANE,
RAINFORD, ST. HELENS, MERSEYSIDE

PHONE 074488 5242



See what the experts have to say...

We proudly present our
NEW GRAPHIC ADVENTURE
The Wheel of Fortune
... widely regarded as the best
available for the BBC Micro

This game is a classic puzzle adventure with all the features you'd expect from EPIC

- HALF SCREEN FULL-COLOUR GRAPHICS FOR EACH OF THE 250 LOCATIONS
- INTELLIGENT MOVING CHARACTERS ACTING IN REAL TIME
- MULTI STATEMENT LANGUAGE AND SPEECH INTERPRETERS

"At last we have an adventure worthy of the BBC Micro... This game must now become a yardstick by which future adventures should be measured." *MICRO ADVENTURER*

"This has to be the adventure of 1984. It really is superb." *MICRONET 800*

"Technically, this game surpasses any I have seen for the BBC Micro." *H.C.W.*

"The definitive adventure. Highly recommended." *ELECTRON USER*

TO: EPIC SOFTWARE, DEPT. A, 10 GLADSTONE ST., KIBWORTH BEAUCHAMP, LEICESTER LE8 0HL *Please Rush Me -*

	CASSETTE	DISC	STATE:
.....qty THE WHEEL OF FORTUNE	£9.95	£11.95	BBC/
.....qty CASTLE FRANKENSTEIN	£7.95	£9.95	ELECTRON
.....qty THE QUEST FOR THE HOLY GRAIL	£7.95	£9.95	(Delete)
.....qty THE KINGDOM OF KLEIN	£7.95	£9.95	No Graphics on Electron

POSTAGE & PACKING FREE FOR 2 OR MORE. ADD 50p FOR ONE.

I enclose Cheque/P.O. to the value of (Payable to 'Epic Software')

NAME _____

ADDRESS _____

POST CODE _____

All programs available for immediate despatch. Dealer enquiries welcome. Help Service. Send letter if you don't want to cut magazine.

THE MICRO PULSE EXTERNAL ROM BOARDS

For the BBC Computer and the Acorn Electron

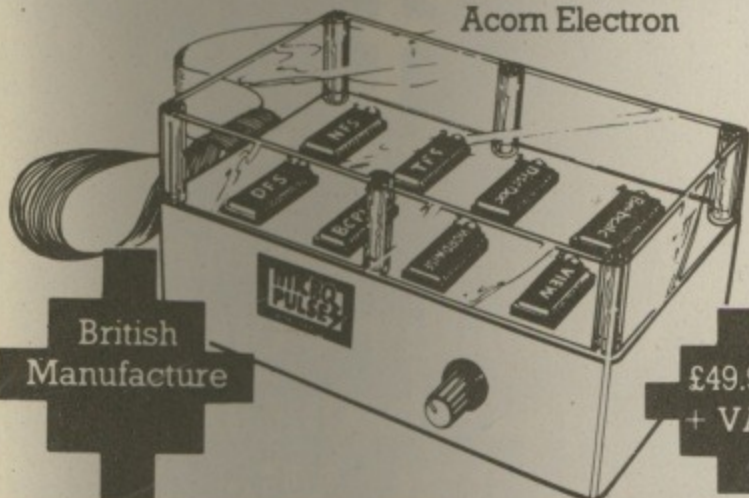

British Manufacture

£49.95 + VAT

- ◆ BRITISH MANUFACTURE ◆ ALLOWS 8 ROMS ON LINE
- ◆ HARDWARE-BASED ROM SELECTION AVOIDS SOFTWARE INTERACTION BETWEEN UTILITY ROMS
- ◆ SWITCH TO REQUIRED ROM USING MANUAL SWITCH OUTSIDE THE UNIT
- ◆ RED LIGHTS INDICATE THE SELECTED ROM
- ◆ HIT "BREAK" TO ACCESS ROM, NO NEED TO USE SOFTWARE COMMAND
- ◆ INCLUDES ZIF SOCKET, FOR INSTANT CHANGING OF A SELECTED ROM
- ◆ INCLUDES BBC CABLE AND ROM SOCKET CONNECTOR
- ◆ INCLUDES SIMPLE FITTING INSTRUCTIONS, JUST PLUG IN AND GO!

please contact: Gareth Luttler
Mark Howard or
Judith Allen at
Micro Pulse
Division

northern computers
more computer systems for all applications

Churchfield Road,
FRODSHAM
Cheshire WA6 6RD
Tel: 0928 35110

THE MICRO PULSE 5.25" DISC DRIVES

ANNOUNCEMENT

- * Northern Computers announce 6 new models of Micropulse 5.25" disc drive, manufactured and assembled in the North West, for the BBC computer. These drives are exactly compatible with the two Acorn/BBC disc formats. They are based on the highest quality Teac mechanisms with built-in power supply, as previously supplied by Cumana Ltd.

- * Prices from **£119.95** + V.A.T.
- * Also: High Quality 3" Compact Disc Drives
- * Prices from **£129.95** + V.A.T.
- * Each Micropulse disc drive is supplied with a BBC cable, formatter utility disc and comprehensive 55page disc filing system manual for the BBC computer.
- * For further details send large S.A.E. to :

northern computers
more computer systems for all applications

Northern Computers,
Churchfield Road,
FRODSHAM
Cheshire WA6 6RD
Tel: 0928 35110

ADVERTISERS INDEX

A&F Software	112, 113	Melbourne House	116, 117
Abacus Business Machines	182	Merlin Computer Products	66
Acornsoft	32, 33, 68, 69	Michael Business Machines	184
Addictive Games	189	Micro Market	8
Advanced memory Systems	67	Micro Power	99, 106, 127, 144, 230
Advanced Technology Products	146, 163	Microbyte	202
Akhter Computers	34	Microdis	195
Alligata Software	83	Microsolve	170
Anthony Gaisford Software	174	Microtest	138
Aries Computers	123	Microvitec	31
BBC Soft	182	Microware	119
Beamscan	174	Microwriter	73
BEC Sports	203	Mighty Micro	170
Beebugsoft	20, 21, 150	Millsoft	174
Beltech	130, 160, 162	Minic Business Services	203
Bevan Technology	103	Miracle Technology	9
BJ Software	170	Mirrorsoft	145
British Micro	98	MP Software	186
C-Tech	110	MRM Software	134
Cambridge Computer Store	218	Musicsoft	188
Care Electronics	198	MW Systems	15
Carson Developments	64	National Micro Centres	166, 167
Chaddington Software	170	New Horizon	
Chase Data	10, 11	Computer Centres	168
CJE Microcomputers	142	Newark Video Centre	204
Clares	12, 13	Northern Computers	217
Compuchess	184	Opus	23, 24, 61, 173
Computamate	136	P&H Electronics	111
Computer Concepts	52	Paeon Systems	141
Computer Marketplace	11	Phi Mag	16, 17
Computer People	218	Printerland	216
Computerama	3	Prism	96, 97
Contex	206	Pro-Soft	174
Cottage Software	168	PV Tubes	184
Crossware Products	168	Qual-Soft	190
Cumana	102	RCS Computer Services	180
Data Efficiency	95	Rexel	118
Data store	146	Ricksoft	176
Datapen	186	Scarab Systems	204
Datastar Systems	168	Silent Computer	206
Dataware	202	Skywave Software	8
Dee-Kay Systems	170	Small School Software	204
Digisolve	78	Soft Shop	7
Disco Technology	22	Softlife	122
Duckworth	176	Software Invasion	6
Electrolink	215	Software Projects	132, 133
Electronequip	74, 75	Software Supermarket	37
Ephagy	182	Solidisk	124, 125
Epic Software	216	SP Electronics	217
Gemini	114, 115	Spinnaker	70
GSL	104	Starbyte	146
Hal Computers	2	Statacom	152
HCR Electronic Services	218	Superior Software	219
Hornby Software	184	Tech Op Ltd	126
Icon	129	Technomatic	55-60
Integrex	86	Tekform	198
J&W Bunce	202	Textel Systems	188
JP Magnetics	203	The Source	182
Kay-Ess	140	Torch	18, 19
Kosmos	141	Triffid Software	165
LCL	198	Tritech Micro Systems	174
Leigh Computer Systems	178	Twilstar	
Level 9 Computing	143		197, 198, 199, 201, 203, 205
Logotron	215	U-Micro	122
Lothlorien	215	United Disk Memories	161
LVL	131	Universal Communications	164
Mannesmann Tally	79	Viglen	88-94
Marbry Planning	174	Vine Micros	206
Mayday	203	Watford Electronics	39-46
		Wizard	188
		4mation	176

ALL IN STOCK

S.P. ELECTRONICS

BBC SPECIALISTS

Acorn Electron	£199.00
BBC Model B 1.2 O.S.	£399.00
CP80 Printer (inc. cable)	£229.00
Disc Operating System	£96.00
Disc Drives	from £175.00
Disc Operating System D-Density	£104.00
G3 WHO RTTY PROGRAM (TAPE)	£7.50
G3 WHO RTTY PROGRAM (EPROM VERSION)	£20.00
Circuit board for RTTY decoder Mk.3 (inc. instructions)	£7.00
Star 10X Printer (inc. cable)	£275.00
CANNON Dot Matrix 160cps NLQ	£350.00
Joysticks (pair) self centering + analogue	from £17.95
Printer Cable (Centronics)	£12.90
Speech Synthesis	£55.00
Disc Doctor	£33.00
WORDWISE Word Processor	£39.00
Slow Scan TV Circuit Board + Program (inc. instructions)	£17.50

Wide selection of software, books, leads, plugs, etc.

SAE for full list. All available Mail Order

48 Linby Road, Hucknall,
Notts. NG15 7TS.

Tel: 0602 640377

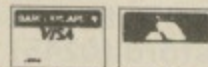

(all prices include VAT)

All prices apply while stocks last.

Carriage extra

HEART MONITOR

Can be used as a Lie Detector, or for monitoring fitness, practising relaxation etc.
The hardware — a built and tested unit which simply plugs into the analogue port — uses an infra-red sensor to detect blood flow in your finger.
SIX screens are generated by the software which include:



A standard ECG screen which gives continuous heartbeat trace with digital pulse readout, optional ECG beep etc.

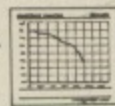

A Rate of Recovery screen which can help in assessing how fit you are by showing how fast your heartrate recovers after exercise. Full details on how to use this and all the other screens are included.

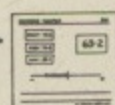

A Bio-Feedback screen which you can use to help you learn to relax, or watch other people's heart reaction to word suggestions or awkward questions etc — can be hysterically funny and often revealing.

The monitor is simple to use: the function keys provide various facilities to alter grid sizes etc., and fast: all time-critical operations are performed by machine code routines.

The monitor unit comes complete with software on cassette or disc (please state 40/80 track), and manual.

Introductory Offer £29.95 inclusive (please add £2 for disc version)

Please make cheques payable to:

COMPUTER PEOPLE
30 Westholme Gardens,
Ruislip, Middlesex.

4

Emmanuel St.

Our new Personal Computer Centre specializing in the BBC Micro with complete support

we know computers

1 Business & Professional
Tel: 0223 65335/4

Home & Educational 4
Tel: 0223 358264

Cambridge Computer Store
1 & 4 Emmanuel Street, Cambridge

16 SOCKET ROM/RAM EXTENSION BOARD

Fully buffered the board offers the following features:

All 16 sockets may contain 8K or 16K roms.

Up to two pairs of sockets may be configured to accept 8K eproms to simulate a 16K eprom without the expense of a 27128.

Up to 16K of CMOS RAM type 6116LP (made up of 8 2K ram chips) may be fitted to 8 of the available sockets leaving 8 free for roms.

or 2 8K Ram chips (6264) leaving 14 available sockets.

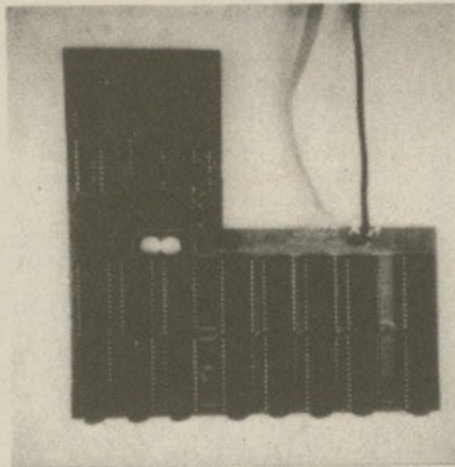

The advantage of sideways ram is twofold:

1. Programs can be assembled directly to hex 8000 and debugged before being committed to eprom.
2. Programs intended for sideways roms may be stored on disc and downloaded into ram. Many more programs may be kept on disc allowing the extension board to be fitted only with roms that need to be resident.

This is a high quality PTH board and plugs into the extreme right hand rom socket. 4 wires to the paging register and one lead to the R/W line have to be connected.

Separate power leads for the board

are used to eliminate possible crashes that may occur due to trying to draw up to 650mA from a sideways rom socket.

Board fully assembled and tested complete with full installation and operating instructions.

Cost £34.50 + VAT, £1.00 P&P

HCR ELECTRONIC SERVICES
THE INDUSTRIAL UNIT, PARKER ROAD
CHELMSFORD, ESSEX CM2 6ES
Tel: Chelmsford (0245) 350188



EXTERNAL RAM/ROM CARD

THE NEW EXTERNAL 28 ROM EXPANSION SYSTEM FROM HCR ELECTRONICS

This extremely powerful but versatile machine has the capability of: 32K RAM & 24 sockets available for ROM or many various combinations to your personal requirements.

This machine has its own separate power supply which eliminates drain on the BBC's switched mode supply.

NO SOLDERING IS REQUIRED.

- The unit consists of two modules:
1. An adaptor board to plug into the BBC sideways Rom socket 15.
 2. The expansion case.

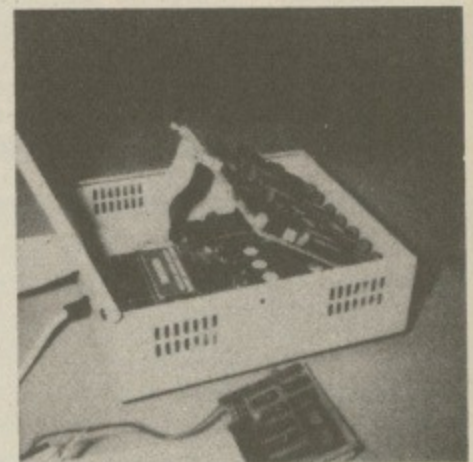

The case comes complete with an inbuilt power supply and one expansion card. This card will hold 12 Roms or a combination of Ram/Rom (Ram can be 6116's, 2016's or 6264's). This gives a total of 16 Roms (including four in machine).

A second board identical to the above can be fitted at a later date, giving a total capability of 28 available sockets for Rom or Ram.

The second board can be selected as an alternative to the first board, either by a switch on the case or via software control.

SOME ADVANTAGES

1. No soldering required.
2. No access into machine required after initial fitting.
3. No overheating problems.
4. Does not physically interfere with other internal expansion add-ons.
5. Built in power supply (does not overload BBC's supply).
6. Computer will still function with external box powered down or unplugged (using Roms resident in machine).
7. Will make available 32K Ram plus 24 Rom sockets at a varied combination to the customer's needs.

Cost unit complete with one board £70.00 + vat. Second board £29.00 + vat. Postage & Packing £3.00



THE BEST BBC MICRO SOFTWARE

* PRODUCED BY AN INDEPENDENT SOFTWARE HOUSE *

* TOP QUALITY MACHINE-CODE PROGRAMS *

**BBC
MICRO**

**SPECIAL
OFFER!**

Deduct £1 per
cassette when
ordering 2
or more

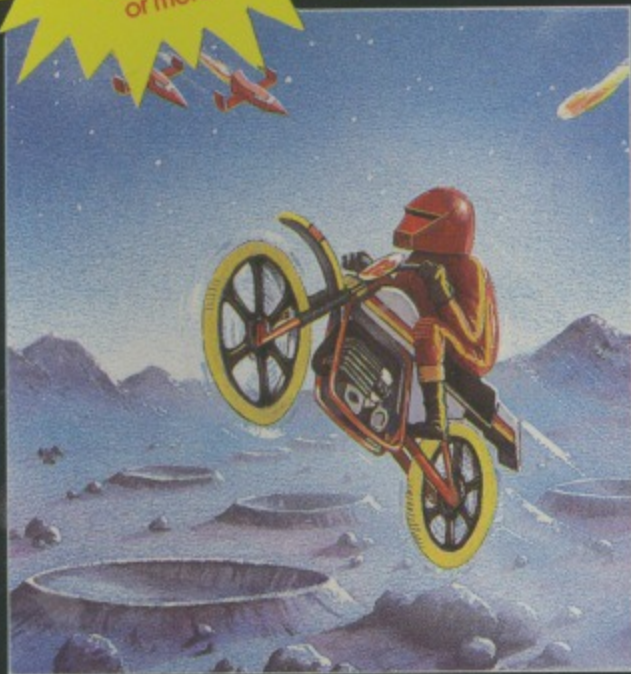

BMX ON THE MOON (32K)

£7.95

Smooth scrolling-screen arcade action. In this game you control a moon cycle which you use to patrol the surface of the moon. You must avoid the rocks on the surface, and also the monsters bouncing high in the low gravity. You should try to shoot down the spaceships which fly overhead dropping bombs onto the moon surface: A further hazard are the flying barrels which are often just too high to shoot or jump over, and just too low to squeeze underneath.

●●●NEW RELEASE●●●



Many of our titles are available in Boots, W.H. Smiths, John Menzies, Rumbelows, Laskys, Currys, HMV, Greens at Debenhams and Spectrum Shops. Also at all major computer dealers – Eltec Computers, Micro Management, West Coast Personal Computers, Microstyle, Electronequip, 3D Computers, Computerama, GTM Computers, etc. Our software is also available through all the major distributors, and directly from us by mail-order.

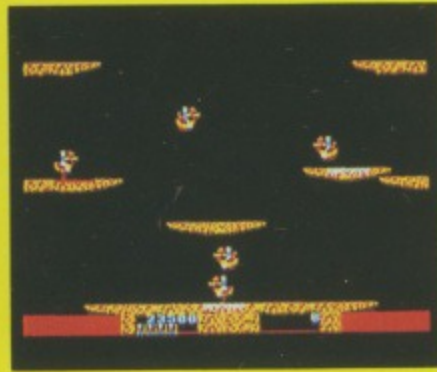

WINGED WARLOADS (32K)

£7.95

A fascinating arcade-style game for one or two players. Each player rides an ostrich, and the aim is to knock the enemy riders off by colliding with them. In a collision the rider with the highest jousting pole will be victorious. If you are successful, the enemy will revert to its original form: an egg. The egg must be collided with to prevent it from hatching. Avoid the lava bath at the bottom of the screen, and remember: you can fly better by using stronger strokes – imagine you are an ostrich trying to fly!

(KEYBOARD OR JOYSTICKS)

●●●NEW RELEASE●●●



SUPERIOR SOFTWARE LTD.

Dept. TM1 1, Regent House,
Skinner Lane, Leeds 7
Tel: 0532 459453

OUR GUARANTEE

- (1) All our software is available before we advertise.
- (2) All our software is despatched within 48 hours by first-class post.
- (3) In the unlikely event that any of our software fails to load, return your cassette to us and we will immediately send a replacement.

M I C R O P O W E R M I C R O P O W E R M

Mr. Freeze!

A SENSATIONAL RELEASE FROM THE AUTHOR OF THE BEST SELLING "KILLER GORILLA" Dig channels through the earth collecting the cherries. Crush the hungry Umphs, Maras and Diggers with the apples, or bounce the Crystal Ball down the tunnels to catch one. Features ten different screens, superb graphical animation and top quality sound.

B.B.C. MICRO



NEW PRICE!
BBC Cassette £6.95
BBC Disk £9.95



WATCH OUT FOR OUR NEW PACKAGING AND CATALOGUE

M I C R O P O W E R

MICRO POWER LTD.,
NORTHWOOD HOUSE, NORTH STREET,
LEEDS LS7 2AA TEL: (0532) 458800
SELECTIVE BRANCHES OF BOOTS, CO-OP,
MENZIES, W. H. SMITH, WOOLWORTHS AND ALL
GOOD DEALERS.
AUTHORS! WE PAY 20% ROYALTIES!



M I C R O P O W E R M I C R O P O W E R M

ERMICROPOWERM

PRE!

B.B.C. MICRO



CRO
WER

POWER LTD.,
HOUSE, NORTH STREET,
TEL: (0532) 458800
SHES OF BOOTS, CO-OP,
K. WOOLWORTHS AND ALL
DEALERS
PAY 20% ROYALTIES!

ERMICROPOWERM

THE MICRO USER

Independent guide to the BBC MICRO!

Volume
Number
November
£1.25

THE MICRO USER

November 1984

Duel!
The most infuriating game we've ever printed

Blockbuster!
Are you fast enough to dodge the gremlins of the maze?

Discover the wonders that lie beyond Prestel

DFS utility to maximise your memory

Blow your own violin with our sound synthesiser



Vol. 2 No. 5